

m

1/4 size
1/2 "
3/4 "

A
B
C

Digitized by



ASSOCIATION
FOR
PRESERVATION
TECHNOLOGY,
INTERNATIONAL
www.apti.org

BUILDING
TECHNOLOGY
HERITAGE
LIBRARY

<https://archive.org/details/buildingtechnologyheritagelibrary>

From the collection of:

Mike Jackson, FAIA

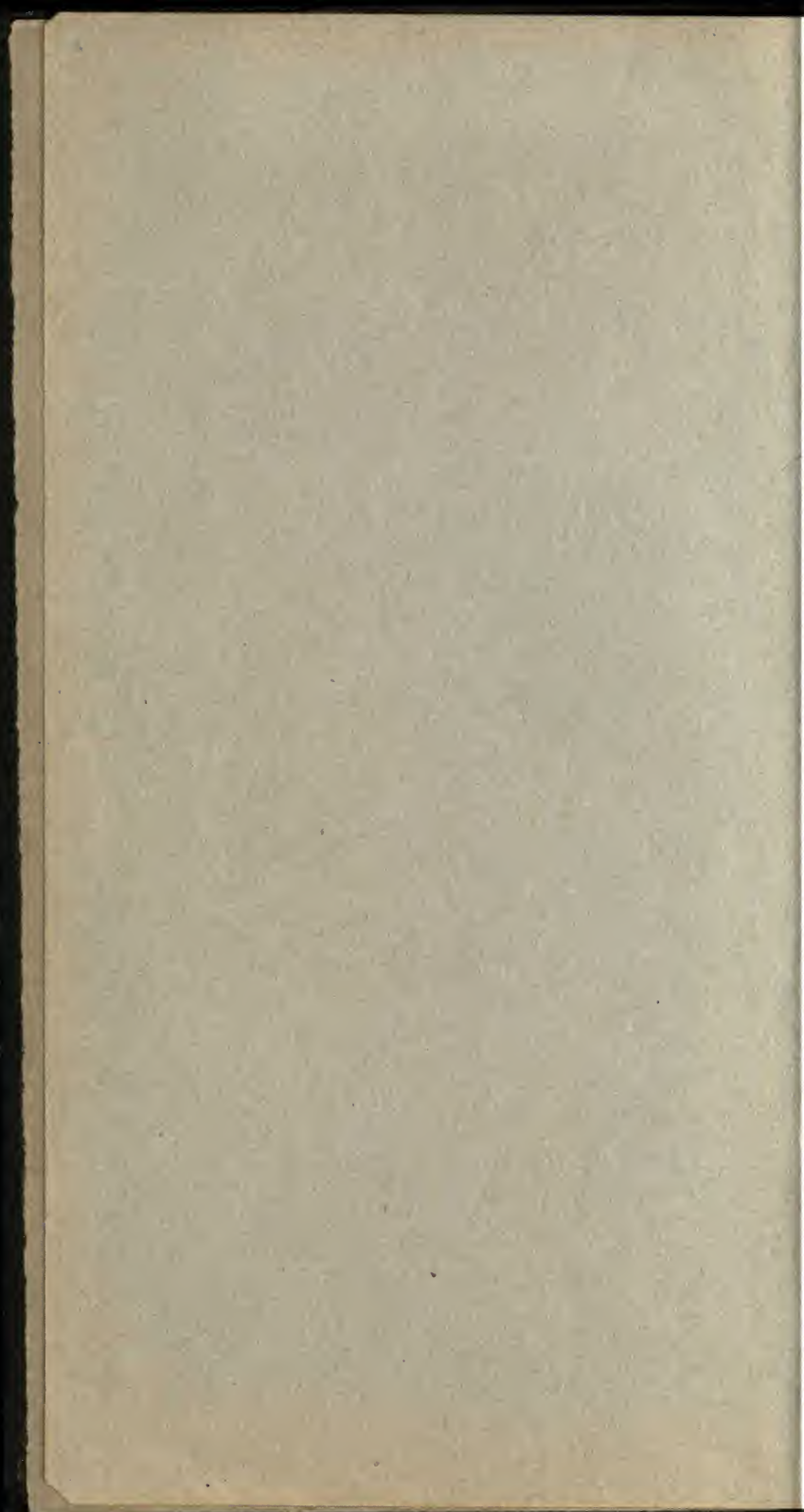

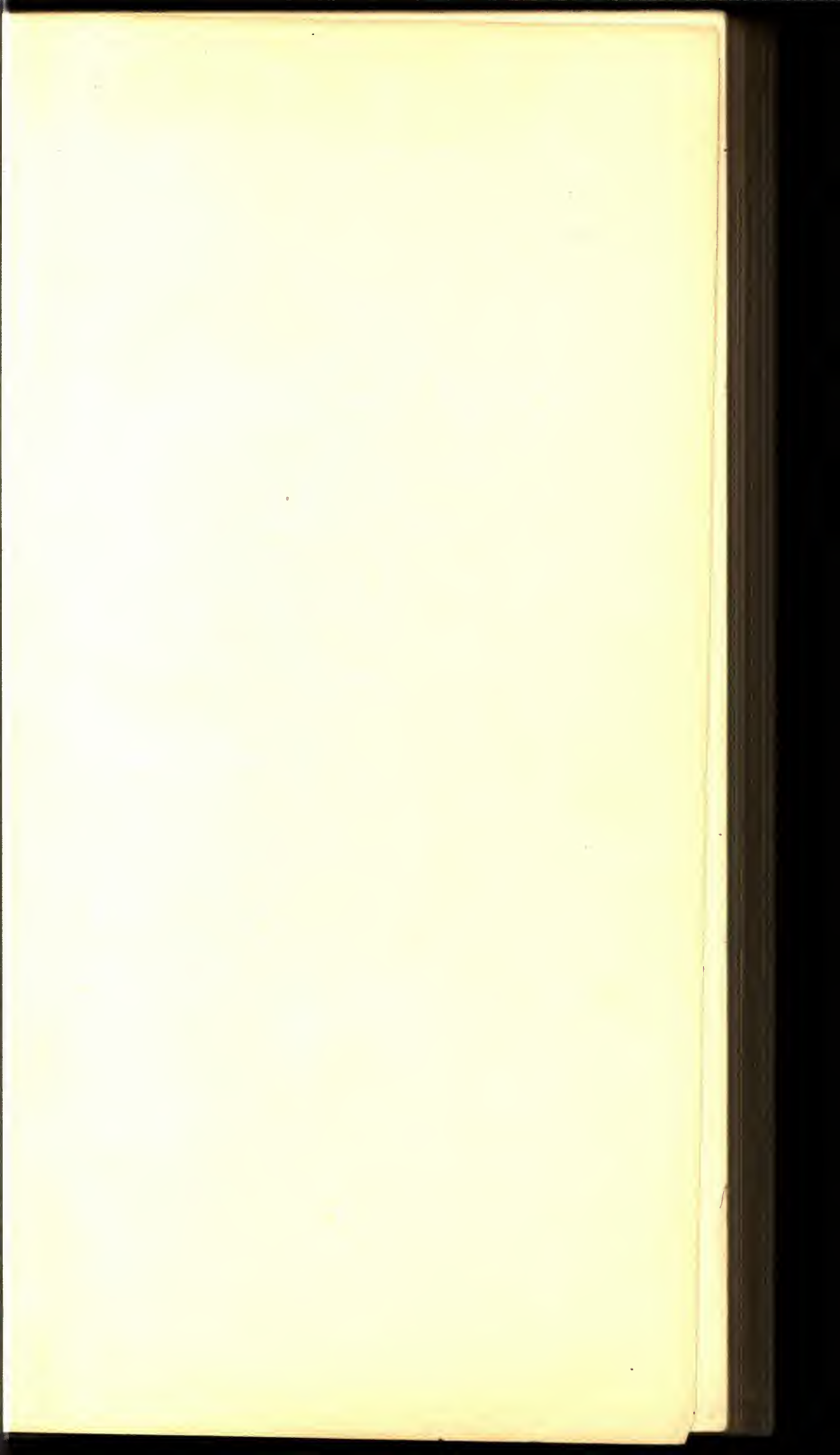

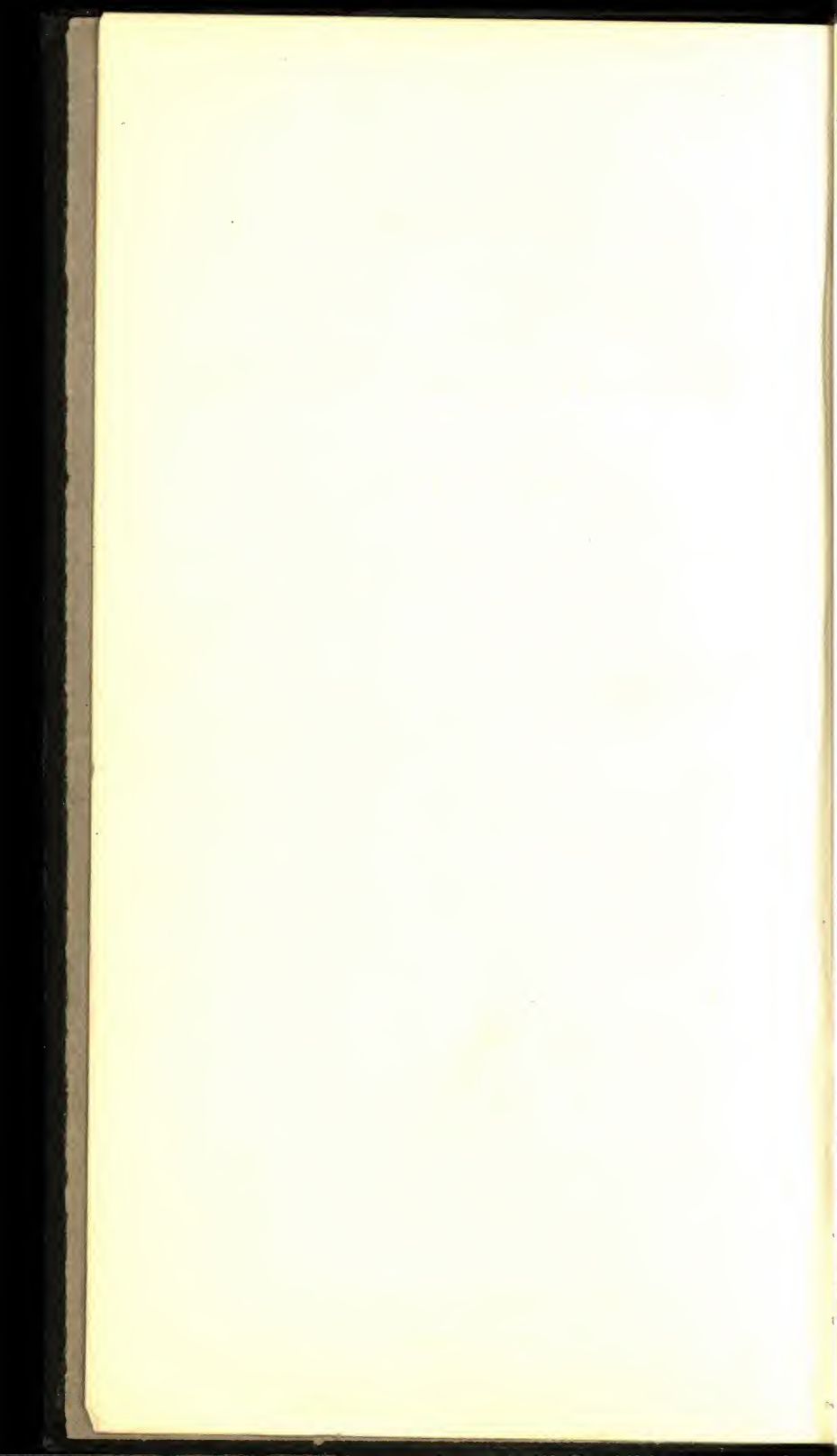

Price List
of
Monumental Marble

April 2, 1923



Vermont Marble Company
Proctor, Vermont

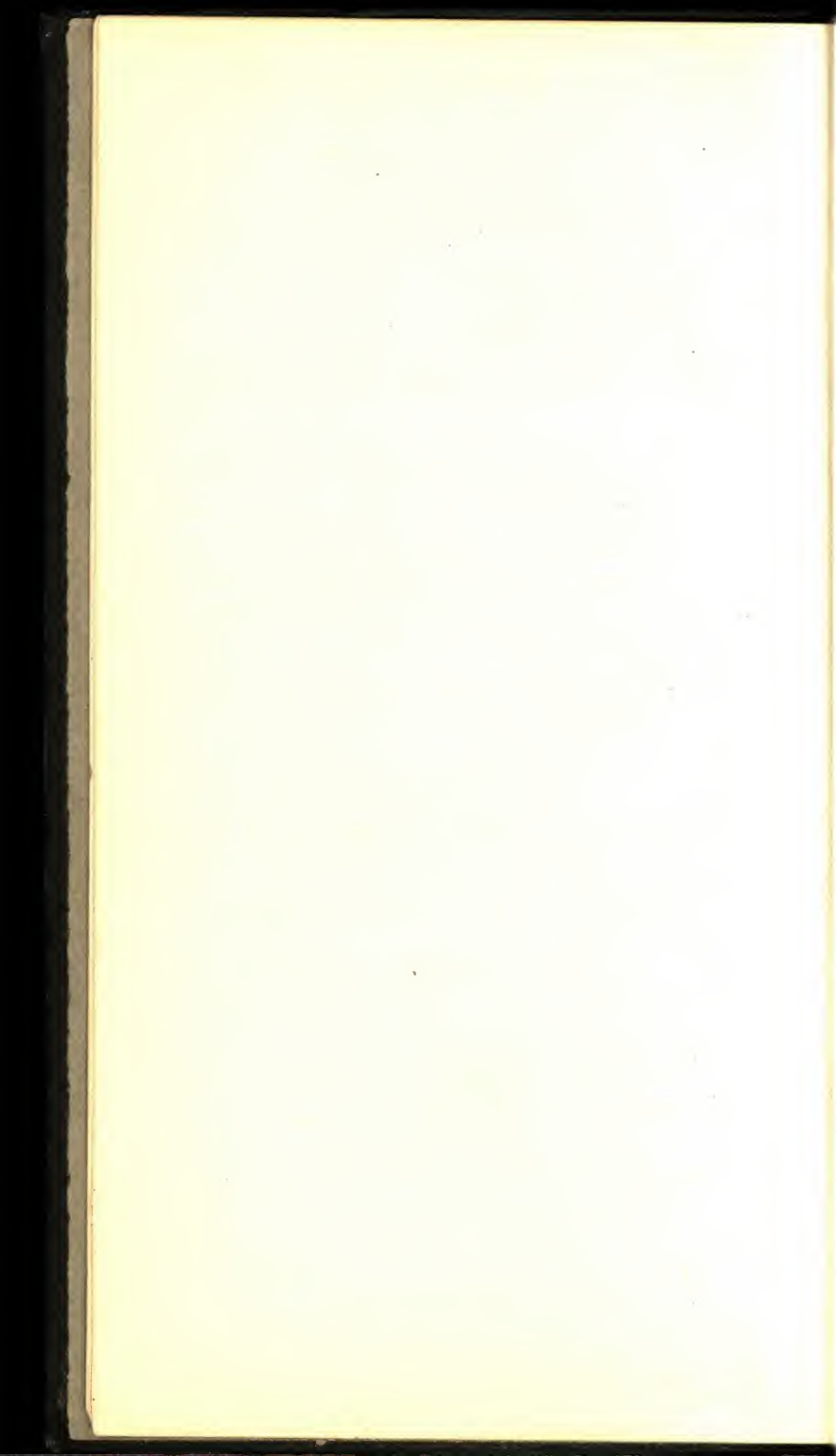

Branch Service

To make it more convenient for our customers, we maintain Branches in various parts of the country. Each Branch has charge of our business in its territory and we believe our relations with you will be best served through the Branch in whose territory you are located. The addresses of our Monumental Branches are as follows:

Boston	10 Thacher St.
New York	101 Park Ave.
Philadelphia	22nd & Westmoreland Sts.
Cleveland	9508 Quincy Ave., S. E.
Chicago	404 E. No. Water St.
San Francisco	244 Brannan St.

To give you the best possible service, our Branches (with the exception of New York) carry well selected stocks of monumental marble, both sand rubbed and finished. An additional charge, varying at each Branch, is made for shipment from Branch stock.

Our cable address is "Vermarble."

Terms of Sale

1. The prices contained in this book are F. O. B. cars at our mills in Vermont.
 2. Invoices for monumental marble or supplies are subject to a 3% discount for cash payment within 30 days from their date. Settlement may be made by three months' bank note of even date with invoice. If not paid in full within 90 days from date, invoices are due and subject to interest at 6% from due date.
 3. A discount of 5% will be given on Vermont marble of our production in carload lots of 36,000 pounds or more in one order.
 4. Prices other than those quoted in this list are not subject to carload or cash discounts.
 5. Orders are not subject to cancellation.
 6. All claims must be made within twenty days from receipt of marble and no charge for work on defective marble will be allowed.
 7. The delivery of goods to the transportation company and the procuring of their shipping receipt therefor shall be considered a delivery to the purchaser.
 8. Should freight overcharges occur and you desire us to assist in collecting them, please send the original paid freight bill and bill of lading, and in case of overweight, a weigher's certificate of the weight.
 9. In case of damage the delivering Freight Agent must certify to the damage, on the original paid freight bill, before the goods are removed from the freight station. If this is not done, no collection can be made from the transportation company.
 10. This price list is for dealers only.
 11. No goods sold at retail.
-

Price List
of
Sawed and Sand Rubbed
Marble

Rutland White

	S. R. and Crated Per cu. ft.
Statuary	\$19.25
No. 1	17.25
Average	12.75
No. 2	10.50
Light Rutland Italian	10.50
Rutland Italian	9.00
Best No. 3	8.00
No. 3	6.50

Vermont Blue

Four inches and over in thickness	S. R. and Crated Per cu. ft.
Extra Dark Blue	\$9.50
Extra Dark Vein	8.50
Dark Vein	7.25
Standard Blue	6.50
If 0.2 thick, extra per cubic foot	\$.50
If 0.3 thick, extra per cubic foot20

Pittsford Valley and Brandon Italian

Four inches and over in thickness	S. R. and Crated Per cu. ft.
Average	\$8.00
No. 2	7.25
Best No. 3	6.50
If 0.2 thick, extra per cubic foot	\$.50
If 0.3 thick, extra per cubic foot20

Sutherland Falls, Pittsford Italian and Riverside

Four inches and over in thickness	S. R. and Crated Per cu. ft.
No. 1	\$10.50
Average	9.50
No. 2	8.00
Best No. 3	6.50
If 0.2 thick, extra per cubic foot	\$.50
If 0.3 thick, extra per cubic foot20

Bottom Bases

	Per cu. ft.
Inferior Blue, Rutland, Pittsford Valley, Pittsford Italian, not sand rubbed, not crated	\$2.15
Inferior Dark Blue, not sand rubbed, not crated	3.00
Light Inferior Rutland, not sand rubbed, not crated	3.15

Subject to extra charge for special selection

Foot Stones

2 inches thick. Ten in one crate. Sawed heads, sand rubbed and crated

0.4 wide, 1.2 to 1.6 long, each	\$.45
0.4 " 1.7 to 2.0 " "53
0.6 " 1.4 to 1.8 " "62
0.6 " 1.9 to 2.0 " "72
0.8 " 1.4 to 1.8 " "72
0.8 " 1.9 to 2.0 " "94

If all ordered of same length, extra 10 per cent.

If both ends ordered sand rubbed, extra 10 per cent.

Posts

INFERIOR	Sawed Heads S. R. & Crated
1. 0 x 0.3 x 0.3 and 0.4 x 0.4, each	\$.44
1. 2 " " " " "50
1. 4 " " " " "57
1. 6 " " " " "65
1. 8 " " " " "71
1.10 " " " " "77
2. 0 " " " " "81
Shorter than 1.0 same price as 1.0	
0. 6 x 0.5 x 0.5 and 0.6 x 0.6, each	\$.55
0. 8 " " " " "66
0.10 " " " " "77
1. 0 " " " " "85
1. 2 " " " " "	1.00
1. 4 " " " " "	1.13
1. 6 " " " " "	1.30
1. 8 " " " " "	1.42
1.10 " " " " "	1.55
2. 0 " " " " "	1.70

Posts odd inches in length will be charged same as next longer size listed.

Posts containing each more than 0.6 cubic will be charged at Bottom Base prices.

Coping Strips and Similar Pieces

	Price Per Cubic Foot		
	2 Inches	3 Inches	4 Inches & Over
Inferior Rutland, Pittsford Valley, Pittsford Italian with Rough Ends, not sand rubbed, not crated	\$2.65	\$2.65	\$2.15
Same with Sawed Ends, not sand rubbed, not crated	3.15	3.15	2.65
Same all sand rubbed and crated	4.90	4.60	3.90
Inferior Blue with Rough Ends, not sand rubbed, not crated	3.10	3.10	2.50
Same with Sawed Ends, not sand rubbed, not crated	3.60	3.60	3.00
Same all sand rubbed and crated	5.35	5.05	4.25
Inferior Dark Blue with Rough Ends, not sand rubbed, not crated	3.65	3.65	
Same with Sawed Ends, not sand rubbed, not crated	4.15	4.15	
Same all sand rubbed and crated	5.90	5.60	
Light Inferior Rutland with Rough Ends, not sand rubbed not crated	3.65	3.65	3.15
Same with Sawed Ends, not sand rubbed, not crated	4.15	4.15	3.65
Same all sand rubbed and crated	5.90	5.60	4.90

When not ordered otherwise, ends will be sawed and charged for.

Grave Covers and Similar Pieces

	Price Per Cubic Foot		
	2 Inches	3 Inches	4 Inches
Inferior Rutland, Pittsford Valley, Pittsford Italian, Sawed Edges if desired, Rough Ends, not sand rubbed, not crated	\$2.90	\$2.90	\$2.40
Same with Sawed Ends, not sand rubbed, not crated	3.40	3.40	2.90
Same Sand Rubbed one side, edges and ends, and crated	4.85	4.60	3.95
Same Sand Rubbed, both sides, edges and ends, and crated	5.15	4.85	4.15

Sand Rubbing and Crating

	S. R.	Crating
Cubic Stock	\$.65 per cu. ft.	\$.60 Per cu. ft.
Slabs 0.3 thick75 " " "	.70 " " "
Slabs 0.2 "90 " " "	.85 " " "
Minimum charge per box or crate		.35

Miscellaneous Prices

Diminishing Dies and Spires	Extra per cu. ft. \$1.25
<p>If pieces are ordered 8.1 to 8.11 long or 5.1 to 5.5 wide, charge extra 35c per cubic foot in either case, and for every additional foot or fraction thereof in length and every additional 6 inches or fraction thereof in width, charge</p>	
" " " "	.35

For unusual sizes ask for special prices

Rutland Slabs, other than full size of block 2, 3 and 4 inches in thickness, in grades of Best No. 3 and higher, ordered to contain 15 sq. ft. or more, extra over list prices quoted herein	10%
Sawing or sand rubbing one end or both ends of slabs 0.2 to 0.4 thick and of strips and similar pieces of any thickness, extra per cu. ft.50

All Rutland, except full size slabs, pieces with coped edges and inferior grades, will be crated and charged for unless otherwise ordered.

All other monumental varieties, except full size slabs and inferior grades, will be sand rubbed and crated and charged accordingly.

Any stock ordered sand rubbed will be crated and so charged.

Inferior grades will not be furnished for monuments, markers or headstones except in bottom bases.

In figuring cubic contents any fraction of an inch will be treated as a whole inch.

Price List
of
Finished
Monumental Marble

Monumental Finishing Rules

1. Tracing on all monuments and tablets will be done as shown in the designs unless otherwise ordered.
2. Tracing of epitaphs, where shown, is done without extra charge.
3. Tracing on urns and other turned work, even though shown in designs, will not be done without special instructions, if balance of monument is not ordered finished.
4. Marble ordered Fine Sand Finished will be given a Grit Finish. If the order calls only for Sand Finish, the marble will be either coarse sanded by hand, or furnished as it comes from the rubbing beds.
5. Boxing of all monuments and crating of Bottom Bases are included in the prices for finished monuments given in this price list.
6. Where inscriptions are shown on any photographs or cuts, such lettering is not included in the list price.
7. Dowel Holes will be drilled in all tablet designs when ordered complete with base.
8. Bottom bases of all finished work will be of Inferior marble and sand finished unless otherwise listed or ordered.

* * * * *

Estimates on any work not quoted in this list will be furnished upon request.

Dowel-Pins which will not rust, either aluminum, brass, copper or composition, should always be used to set marble work. Galvanized iron should not be used.

M. M. Finish S. S. Bottom Bases

"M. M." finish is distinctive. It is not a machine process; it is a hand-chisel method requiring more than average skill, gaining thereby the character and richness which come only through individual work. In appearance it is in direct contrast to polished marble. Under the magnifying glass it shows a surface covered with fine parallel lines or ridges. It has the bright crystalline quality of natural stone without the roughness.

We recommend all the following varieties without reservation, and especially gray, provided they are ordered in the grades specified.

	Class
Gray	K
Pittsford Valley or Brandon Italian	K or I
Riverside	K or I
Rutland	I or D

This "M. M." finish is not intended to supplant the other finishes. Nor is it suitable for all designs. The dealer will understand where it can best be used. To avoid confusion every order should give complete information as to how the marble is to be finished.

"M. M." finish memorials will be provided with what is termed "S.S." (Selected Stock) bottom bases. All such bases will be of special selection.

"S. S." bottom bases with either "M. M." or "hand sand" finish can be substituted in designs listed with regular inferior bottom bases at an additional charge of \$1.75 per cubic foot.

The designs listed in this book in "M. M." finish can be furnished in polish, hone or sand finish at the same price.

Index of Grades According to Class and Price

Rutland White

Grade	Class	Price Per cu. ft.
Statuary	A	\$18.00
No. 1	B	16.00
Average	C	11.50
No. 2 or Light Rutland Italian	D	9.25
Rutland Italian	G	7.75
Best No. 3	I	6.75
No. 3	L	5.25

Vermont Blue

Grade	Class	Price Per cu. ft.
Extra Dark Blue	F	\$8.25
Extra Dark Vein	H	7.25
Dark Vein	K	6.00
Standard Blue	L	5.25

Pittsford Valley and Brandon Italian

Grade	Class	Price Per cu. ft.
Average	I	\$6.75
No. 2	K	6.00
Best No. 3	L	5.25

Sutherland Falls, Pittsford Italian and Riverside

Grade	Class	Price Per cu. ft.
No. 1	D	\$9.25
Average	F	8.25
No. 2	I	6.75
Best No. 3	L	5.25

Bottom Bases

Inferior Blue, Rutland, Pittsford Valley or Pittsford Italian, Wash Cut,
Sand Finished and Crated

Containing 1.0 cubic and less	Per cu. ft.	\$3.75
“ 1.1 “ to 3.0 cubic inclusive	“ “ “	3.60
“ 3.1 “ and more	“ “ “	3.50

Changes in sizes will be figured according to these prices

No. 518

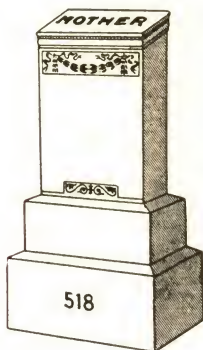

Die.....1. 6 x 0.10 x 2.8..3. 4
 Base.....1.10 x 1. 2 x 0.8..1. 5
 B. Base...2. 4 x 1. 8 x 1.0..3.11
 Weight complete 1525 lbs.; no B. B. 820 lbs.
 C.....\$95.50
 D.....85.00
 F.....80.00
 G.....78.00
 H.....75.50
 I.....73.00
 K.....69.50
 L.....66.00
 If B. B. is omitted deduct \$13.70

No. 518¹/₄

Die.....1.4 x 0.8 x 2. 2..1.11
 Base.....1.8 x 1.0 x 0. 8..1. 1
 B. Base...2.0 x 1.4 x 0.10..2. 3
 Weight complete 925 lbs.; no B. B. 520 lbs.
 C.....\$66.50
 D.....59.50
 F.....56.50
 G.....55.00
 H.....53.50
 I.....52.00
 K.....49.75
 L.....47.50
 If B. B. is omitted deduct \$8.10

No. 518¹/₂

Die.....1.4 x 0. 6 x 2.0..1.4
 Base.....1.8 x 0.10 x 0.6..0.8
 B. Base...2.0 x 1. 2 x 0.8..1.7
 Weight complete 635 lbs.; no B. B. 350 lbs.
 C.....\$46.75
 D.....42.25
 F.....40.25
 G.....39.25
 H.....38.25
 I.....37.25
 K.....35.75
 L.....34.25
 If B. B. is omitted deduct \$5.70

No. 576

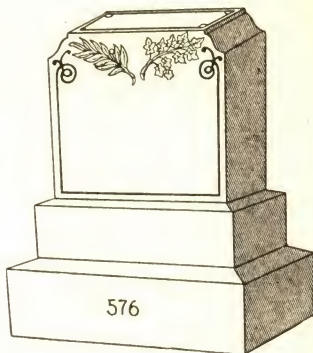

Die.....2.4 x 0.10 x 2.4..4.6
 Base.....2.8 x 1. 2 x 0.8..2.1
 B. Base...3.2 x 1. 8 x 1.0..5.3
 Weight complete 2075 lbs.; no B.B.1130 lbs.
 C.....\$119.00
 D.....104.00
 F.....97.50
 G.....94.50
 H.....91.00
 I.....88.00
 K.....83.00
 L.....78.00
 If B. B. is omitted deduct \$18.40

No. 576¹/₄

Die.....2. 0 x 0.8 x 2.0..2.8
 Base.....2. 4 x 1.0 x 0.8..1.7
 B. Base...2.10 x 1.6 x 1.0..4.3
 Weight complete 1475 lbs.; no B. B. 710 lbs.
 C.....\$87.00
 D.....77.50
 F.....73.50
 G.....71.00
 H.....69.00
 I.....67.00
 K.....64.00
 L.....60.50
 If B. B. is omitted deduct \$14.90

No. 576¹/₂

Die.....1.6 x 0.6 x 1. 6..1.2
 Base.....1.9 x 0.9 x 0. 5..0.7
 B. Base...2.2 x 1.2 x 0.10..2.1
 Weight complete 675 lbs.; no B. B. 300 lbs.
 C.....\$40.00
 D.....36.00
 F.....34.25
 G.....33.50
 H.....32.50
 I.....31.75
 K.....30.50
 L.....29.00
 If B. B. is omitted deduct \$7.50

No. 596

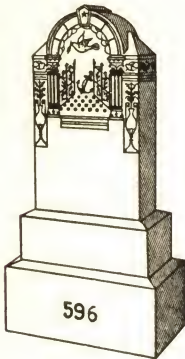

Die.....1.10 x 1. 0 x 3.05. 6
 Base.....2. 2 x 1. 4 x 0.81.11
 B. Base....2. 8 x 1.10 x 1.25. 8
 Weight complete 2550 lbs.; no B. B. 1530 lbs.

- C.....\$148.00
- D.....132.00
- F.....124.00
- G.....121.00
- H.....117.00
- I.....113.00
- K.....108.00
- L.....102.00

If B. B. is omitted deduct \$19.85

No. 596¹/₄

Die.....1.8 x 0.10 x 2.103.11
 Base.....2.0 x 1. 2 x 0. 81. 7
 B. Base....2.4 x 1. 6 x 1. 03. 6
 Weight complete 1575 lbs.; no B. B. 945 lbs.

- C.....\$110.00
- D.....97.50
- F.....92.00
- G.....89.00
- H.....86.50
- I.....83.50
- K.....79.50
- L.....75.50

If B. B. is omitted deduct \$12.25

No. 596¹/₂

Die.....1. 6 x 0.8 x 2.82. 8
 Base.....1.10 x 1.0 x 0.81. 3
 B. Base....2. 2 x 1.4 x 1.02.11
 Weight complete 1200 lbs.; no B. B. 675 lbs.

- C.....\$83.00
- D.....74.00
- F.....70.00
- G.....68.00
- H.....66.00
- I.....64.00
- K.....61.00
- L.....58.50

If B. B. is omitted deduct \$10.50

No. 625

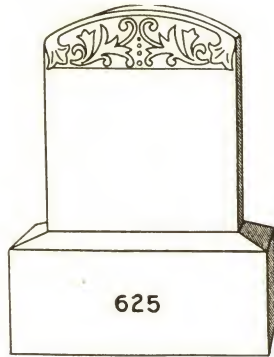

Die.....1.2 x 0.4 x 1.40.6
 B. Base.....1.6 x 0.8 x 0.80.8
 Weight complete 200 lbs.; no B. B. 110 lbs.

- C.....\$13.50
- D.....12.25
- F.....11.75
- G.....11.50
- H.....11.25
- I.....11.00
- K.....10.50
- L.....10.25

If B. B. is omitted deduct \$2.50

No. 625¹/₄

Die.....1.0 x 0.4 x 1.20.5
 B. Base.....1.4 x 0.8 x 0.80.7
 Weight complete 175 lbs.; no B. B. 70 lbs.

- C.....\$11.00
- D.....10.00
- F.....9.75
- G.....9.50
- H.....9.25
- I.....9.00
- K.....8.50
- L.....8.25

If B. B. is omitted deduct \$2.20

No. 626

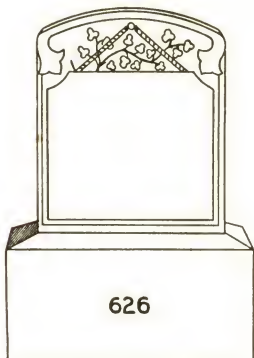

Sizes and prices same as 625.

No. 626 $\frac{1}{4}$

Sizes and prices same as 625 $\frac{1}{4}$.

No. 627

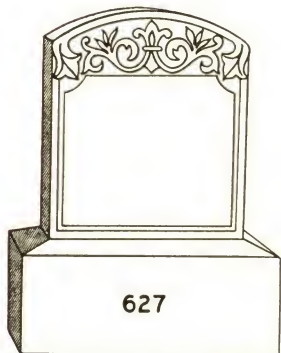

Sizes and prices same as 625.

No. 627 $\frac{1}{4}$

Sizes and prices same as 625 $\frac{1}{4}$.

No. 641

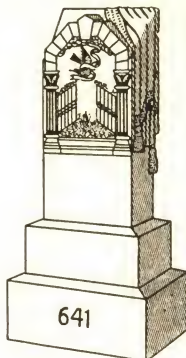

Die.....1.5 x 0.10 x 2.10..3.4
 Base.....1.8 x 1.2 x 0.8..1.4
 B. Base....2.0 x 1.6 x 1.0..3.0
 Weight complete 1300 lbs.; no B. B. 760 lbs.

C.....	\$107.00
D.....	97.00
F.....	92.00
G.....	90.00
H.....	87.50
I.....	85.00
K.....	81.50
L.....	78.00

If B. B. is omitted deduct \$10.80

No. 641 $\frac{1}{4}$

Die.....1.3 x 0.8 x 2.6..2.1
 Base.....1.6 x 1.0 x 0.8..1.0
 B. Base....1.10 x 1.4 x 0.10..2.0
 Weight complete 875 lbs.; no B. B. 515 lbs.

C.....	\$77.00
D.....	70.00
F.....	67.00
G.....	65.50
H.....	64.00
I.....	62.50
K.....	60.00
L.....	57.00

If B. B. is omitted deduct \$7.20

No. 645

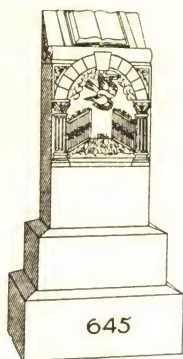

Die.....1.4 x 0.10 x 2.10 .3.2
 Base.....1.8 x 1.2 x 0.8 .1.4
 B. Base....2.0 x 1.6 x 1.0 .3.0
 Weight complete 1275 lbs.; no B. B. 735 lbs.

C.....\$92.50
 D.....82.50
 F.....78.00
 G.....75.50
 H.....73.50
 I.....71.00
 K.....67.50
 L.....64.50

If B. B. is omitted deduct \$10.50

No. 645¹/₄

Die.....1.2 x 0.8 x 2.6 .1.11
 Base.....1.6 x 1.0 x 0.8 .1.0
 B. Base....1.10 x 1.4 x 0.10 .2.0
 Weight complete 850 lbs.; no B. B. 490 lbs.

C.....\$66.00
 D.....59.50
 F.....56.50
 G.....55.00
 H.....53.50
 I.....52.00
 K.....50.00
 L.....47.75

If B. B. is omitted deduct \$7.20

No. 645¹/₂

Die.....1.0 x 0.6 x 2.2 .1.1
 Base.....1.4 x 0.10 x 0.6 .0.7
 B. Base....1.8 x 1.2 x 0.10 .1.7
 Weight complete 560 lbs.; no B. B. 275 lbs.

C.....\$41.00
 D.....37.25
 F.....35.75
 G.....34.75
 H.....34.00
 I.....33.25
 K.....32.00
 L.....30.75

If B. B. is omitted deduct \$5.70

No. 650

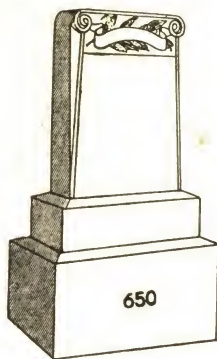

Die.....1.6 x 0.6 x 2.0 .1.6
 Base.....1.9 x 0.9 x 0.5 .0.7
 B. Base....2.2 x 1.2 x 0.10 .2.1
 Weight complete 725 lbs.; no B. B. 350 lbs.

C.....\$44.50
 D.....39.75
 F.....37.75
 G.....36.75
 H.....35.50
 I.....34.50
 K.....33.00
 L.....31.50

If B. B. is omitted deduct \$7.50

No. 650¹/₄

Die.....1.6 x 0.4 x 2.0 .1.0
 Base.....1.9 x 0.7 x 0.4 .0.4
 B. Base....2.2 x 1.0 x 0.10 .1.10
 Weight complete 560 lbs.; no B. B. 230 lbs.

C.....\$33.25
 D.....30.25
 F.....28.75
 G.....28.25
 H.....27.50
 I.....26.75
 K.....25.75
 L.....24.75

If B. B. is omitted deduct \$6.60

No. 657

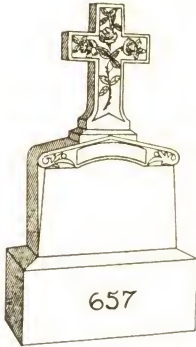

Cross.....1.2 x 0.4 x 1.8..0.8
 Die.....2.0 x 0.8 x 1.8..2.3
 B. Base.....2.6 x 1.2 x 1.0..2.11

Weight complete 975 lbs.; no B. B. 450 lbs.

C.....	\$73.00
D.....	66.50
F.....	63.50
G.....	62.00
H.....	60.50
I.....	59.00
K.....	57.00
L.....	55.00

If B. B. is omitted deduct \$10.50

No. 683

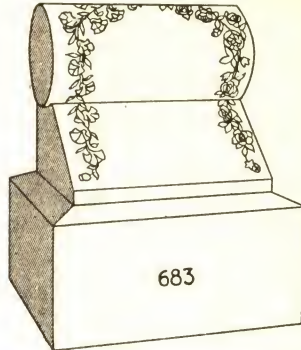

Roll.....1.8 x 0.10 x 0.10..1.2
 Base.....1.7 x 1.2 x 0.8..1.3
 B. Base.....2.0 x 1.7 x 1.0..3.2

Weight complete 825 lbs.; no B. B. 255 lbs.

C.....	\$57.00
D.....	51.50
F.....	49.25
G.....	48.00
H.....	46.75
I.....	45.75
K.....	43.75
L.....	42.00

If B. B. is omitted deduct \$11.10

No. 657¹/₄

Cross.....1.1 x 0.4 x 1.6..0.7
 Die.....1.10 x 0.6 x 1.8..1.6
 B. Base.....2.4 x 1.0 x 1.0..2.4

Weight complete 750 lbs.; no B. B. 330 lbs.

C.....	\$57.50
D.....	53.00
F.....	51.00
G.....	50.00
H.....	48.75
I.....	47.75
K.....	46.25
L.....	44.75

If B B is omitted deduct \$8.40

No. 683¹/₄

Roll.....1.8 x 0.8 x 0.8..0.9
 Base.....1.7 x 1.0 x 0.6..0.10
 B. Base.....2.0 x 1.5 x 0.10..2.4

Weight complete 650 lbs.; no B. B. 230 lbs.

C.....	\$43.25
D.....	39.75
F.....	38.25
G.....	37.50
H.....	36.50
I.....	35.75
K.....	34.75
L.....	33.50

If B B. is omitted deduct \$8.40

No. 720

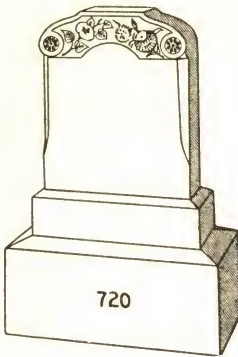

Die.....1.6 x 0.6 x 1.8..1.3
 Base.....1.8 x 0.8 x 0.4..0.4
 B. Base.....2.0 x 1.0 x 0.10..1.8
 Weight complete 580 lbs.; no B. B. 280 lbs.

C.....\$36.00
 D.....32.50
 F.....31.00
 G.....30.25
 H.....29.25
 I.....28.50
 K.....27.50
 L.....26.25
 If B. B. is omitted deduct \$6.00

No. 720¹/₄

Die.....1.4 x 0.4 x 1.6..0.8
 Base.....1.6 x 0.6 x 0.4..0.3
 B. Base.....1.10 x 0.10 x 0.8..1.0
 Weight complete 335 lbs.; no B. B. 155 lbs.

C.....\$22.00
 D.....20.00
 F.....19.00
 G.....18.50
 H.....18.00
 I.....17.75
 K.....17.00
 L.....16.25
 If B. B. is omitted deduct \$3.75

No. 720¹/₂

Die.....1.4 x 0.4 x 1.4..0.7
 Base.....1.6 x 0.6 x 0.4..0.3
 B. Base.....1.10 x 0.10 x 0.8..1.0
 Weight complete 325 lbs.; no B. B. 145 lbs.

C.....\$20.00
 D.....18.25
 F.....17.25
 G.....17.00
 H.....16.50
 I.....16.00
 K.....15.50
 L.....14.75
 If B. B. is omitted deduct \$3.75

No. 1220

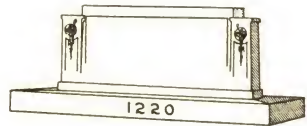

Die.....6.0 x 0.10 x 2.6..12.6
 Base.....6.2 x 1.0 x 0.4..2.1
 B.Ba. (S.S.)..8.2 x 2.0 x 0.10..13.8
 Weight complete 4500

D.....\$397.00
 F.....383.00
 G.....376.00
 H.....368.00
 I.....361.00
 K.....350.00
 L.....339.00

"M. M." finish

No. 1220¹/₄

Die.....5.0 x 0.8 x 2.4..7.9
 Base.....5.2 x 0.10 x 0.3..1.1
 B. Ba. (S.S.)..7.2 x 1.8 x 0.8..8.0
 Weight complete 2600 lbs.

D.....\$293.00
 F.....285.00
 G.....280.00
 H.....276.00
 I.....271.00
 K.....265.00
 L.....258.00

"M. M." finish

No. 1221

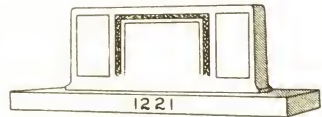

Die.....6.0 x 1.0 x 2.10..17.0
 B.Ba. (S.S.)..8.0 x 1.10 x 0.10..12.3
 Weight complete 5100 lbs.

D.....\$428.00
 F.....412.00
 G.....403.00
 H.....395.00
 I.....386.00
 K.....373.00
 L.....361.00

"M. M." finish

No. 1221¹/₄

See next page

No. 1222

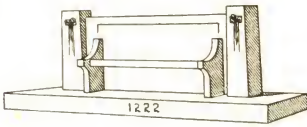

2 Po.....	1.0 x 1.0 x 3.0	6.0
Back.....	5.7 x 0.8 x 2.10	10.7
Seat.....	4.8 x 1.1 x 0.4	1.8
Supports...	0.5 x 1.3 x 2.2	2.4
B.Ba. (S.S.)	8.6 x 2.8 x 0.8	15.1

Weight complete 6300 lbs.

D.....	\$505.00
J.....	485.00
G.....	474.00
H.....	464.00
I.....	454.00
K.....	438.00
L.....	423.00

"M. M." finish

No. 1223

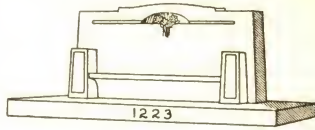

Die.....	6.0 x 1.8 x 3.4	33.4
B.Ba. (S.S.)	8.0 x 2.8 x 0.10	17.9

Weight complete 7500 lbs.

D.....	\$684.00
F.....	649.00
G.....	634.00
H.....	617.00
I.....	600.00
K.....	575.00
L.....	550.00

"M. M." finish

No. 1224

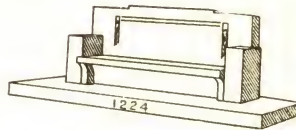

No. 1221¹/₄

Die.....	5.0 x 0.10 x 2.6	10.5
B.Ba. (S.S.)	7.0 x 1.8 x 0.10	9.9

Weight complete 3500 lbs.

D.....	\$324.00
F.....	314.00
G.....	309.00
H.....	303.00
I.....	298.00
K.....	290.00
L.....	283.00

"M. M." finish

Die.....	6.6 x 1.8 x 3.4	36.1
B. Ba. (S.S.)	8.6 x 3.0 x 0.8	17.0

Weight complete 7500 lbs.

D.....	\$736.00
F.....	700.00
G.....	682.00
H.....	664.00
I.....	646.00
K.....	619.00
L.....	592.00

"M. M." finish

No. 1280



Statue, 6.0 high

Total height of monument,
15 ft. 5 in.

Overall size of base, 17 ft. 4 in.
7 ft. 8 in.

Scale drawing giving complete sizes
furnished on application.

Weight complete 50000 lbs.

K stock..... \$4,550.00

No. 1281

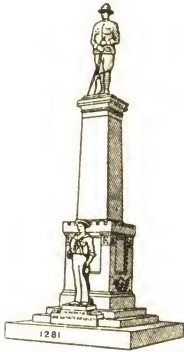

Statue.....6.0 high
 Cap.....2. 2x2. 2x1. 0. 4.8
 Die.....2. 0x2. 0x5.10. 23.4
 Plinth.....3. 2x3. 2x0.10. 8.4
 Die.....2.10x2.10x3. 2. 25.5
 Base.....3. 4x3. 4x1. 2. 13.0
 Base.....6. 0x5. 6x1. 0. 32.6
 B. Base...8. 0x8. 0x1. 0. 64.0

Statue.....5.10 high

Weight complete 30000 lbs.

C.....\$4294.00
 D.....4054.00
 F.....3946.00
 G.....3893.00
 H.....3839.00
 I.....3786.00
 K.....3706.00
 L.....3625.00

Statues in "I" grade white stock; crossed flags carved on right side of die, anchor on left and crossed cannon barrels on back.

No. 1282 1/2

Statue.....6.0 high
 Cap.....3.4x3.4x0.10. 9.3
 Plinth.....2.8x2.8x1. 2. 8.4
 Die.....2.8x2.8x3. 9. 26.8
 Base.....3.4x3.4x0.10. 9.3
 Base.....4.5x4.5x0. 8. 13.0
 B. Base...6.2x6.2x1. 0. 38.0

C.....\$2243.00
 D.....2093.00
 F.....2027.00
 G.....1994.00
 H.....1960.00
 I.....1927.00
 K.....1877.00
 L.....1827.00

Statue in "I" grade white stock; all polished; if grit finished deduct \$25.00.

No. 1282



Statue.....6.6 high
 Cap.....4. 3x4. 3x1. 0. 18. 1
 Plinth...3. 4x3. 4x1. 4. 14.10
 Die.....3. 4x3. 4x4. 8. 51.10
 Base.....4. 2x4. 2x1. 0. 17. 4
 Base.....5. 7x5. 7x0.10. 26. 0
 B. Base..7.10x7.10x1. 2. 71. 8

C.....\$3552.00
 D.....3264.00
 F.....3136.00
 G.....3072.00
 H.....3010.00
 I.....2944.00
 K.....2848.00
 L.....2752.00

Statue in "I" grade white stock; all polished; if grit finished deduct \$45.00.

No. 1282 1/4

Statue.....6.3 high
 Cap.....3.8x3.8x0.10. 11.2
 Plinth...3.0x3.0x1. 3. 11.3
 Die.....3.0x3.0x4. 2. 37.6
 Base.....3.9x3.9x0.10. 11.9
 Base.....5.0x5.0x0. 9. 18.9
 B. Base...7.0x7.0x1. 1. 53.1

C.....\$2798.00
 D.....2595.00
 F.....2505.00
 G.....2460.00
 H.....2415.00
 I.....2370.00
 K.....2302.00
 L.....2235.00

Statue in "I" grade white stock; all polished; if grit finished deduct \$35.00.

No. 1282 1/2

See previous column

No. 1440

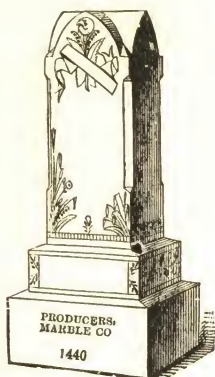

Die.....1. 0x1. 0x3.0..3. 0
 Base.....1. 4x1. 4x0.6..0.11
 B. Base...1. 10x1.10x1.0..3. 4
 Weight complete 1275 lbs.; no B. B. 675 lbs.

C.....	\$80.50
D.....	71.50
F.....	67.50
G.....	65.50
H.....	63.50
I.....	61.50
K.....	58.50
L.....	56.00

If B. B. is omitted deduct \$11.65

No. 1440¹/₄

Die.....0.10x0.10x2. 6..1. 9
 Base.....1. 2x1. 2x0. 6..0. 8
 B. Base...1. 6x1. 6x0.10..1.11
 Weight complete 750 lbs.; no B. B. 405 lbs.

C.....	\$54.00
D.....	48.50
F.....	46.00
G.....	44.75
H.....	43.50
I.....	42.50
K.....	40.50
L.....	38.75

If B. B. is omitted deduct \$6.90

No. 1440¹/₂

Die.....0.8x0.8x2.0..0.11
 Base.....1.0x1.0x0.6..0. 6
 B. Base...1.4x1.4x0.8..1. 2
 Weight complete 425 lbs.; no B. B. 215 lbs.

C.....	\$33.50
D.....	30.25
F.....	28.75
G.....	28.00
H.....	27.25
I.....	26.75
K.....	25.50
L.....	24.50

If B. B. is omitted deduct \$4.20

No.1936

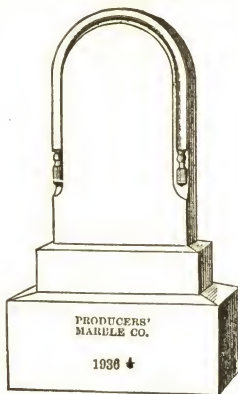

Die.....1. 6x0. 6x2.6..1.11
 Base.....1.10x0.10x0.6..0. 9
 B. Base...2. 4x1. 4x1.0..3. 1
 Weight complete 1000 lbs.; no B. B. 445 lbs.

C.....	\$59.50
D.....	53.50
F.....	50.50
G.....	49.25
H.....	48.00
I.....	46.75
K.....	44.75
L.....	42.75

If B. B. is omitted deduct \$10.80

No. 1936¹/₄

Die.....1. 6x0.4x2.6..1.3
 Base.....1.10x0.8x0.6..0.7
 B. Base...2. 4x1.2x1.0..2.9
 Weight complete 800 lbs.; no B. B. 305 lbs.

C.....	\$47.50
D.....	43.50
F.....	41.50
G.....	40.75
H.....	39.75
I.....	38.75
K.....	37.50
L.....	36.00

If B. B. is omitted deduct \$9.90

No. 1981—B

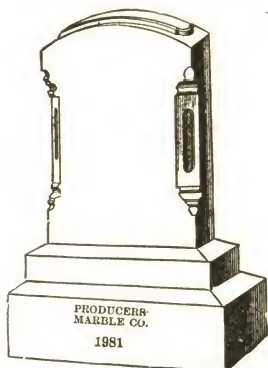

Die.....1.8 x 0.6 x 2.8 .2. 3
 Base.....2.0 x 0.10 x 0.6 .0.10
 B. Base....2.4 x 1.2 x 1.0 .2. 9
 Weight complete 1000 lbs.; no B. B. 505 lbs.

- C.....\$67.50
- D.....60.50
- F.....57.50
- G.....56.00
- H.....54.50
- I.....53.00
- K.....50.50
- L.....48.25

If B. B. is omitted deduct \$9.90

No. 1981—I

Die.....1.6 x 0.6 x 2.0 .1.6
 Base.....1.9 x 0.9 x 0.5 .0.7
 B. Base....2.2 x 1.2 x 0.10 .2.1
 Weight complete 700 lbs.; no B. B. 325 lbs.

- C.....\$47.00
- D.....42.25
- F.....40.25
- G.....39.25
- H.....38.00
- I.....37.00
- K.....35.50
- L.....34.00

If B. B. is omitted deduct \$7.50

No. 1981—K

Die.....1.6 x 0.5 x 2.0 .1. 3
 Base.....1.9 x 0.8 x 0.5 .0. 6
 B. Base....2.2 x 1.1 x 0.10 .1.11
 Weight complete 550 lbs.; no B. B. 205 lbs.

- C.....\$43.75
- D.....40.00
- F.....38.00
- G.....37.25
- H.....36.25
- I.....35.50
- K.....34.25
- L.....32.75

If B. B. is omitted deduct \$6.90

No. 1992



Die.....1.0 x 0.4 x 1.0 .0. 4
 Base.....1.2 x 0.6 x 0.4 .0. 2
 B. Base....1.6 x 0.10 x 0.8 .0.10
 Weight complete 250 lbs.; no B. B. 215 lbs.

- C.....\$20.75
- D.....19.75
- F.....19.25
- G.....19.00
- H.....18.75
- I.....18.50
- K.....18.00
- L.....17.75

If B. B. is omitted deduct \$3.15

No. 1997

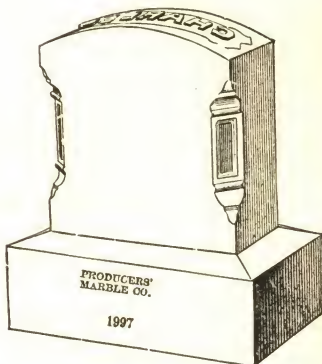

Die.....1.4 x 0.6 x 1.4 .0.11
 B. Base....1.8 x 0.10 x 0.8 .0.11
 Weight complete 300 lbs.; no B. B. 135 lbs.

- C.....\$22.50
- D.....20.50
- F.....19.50
- G.....19.00
- H.....18.50
- I.....18.25
- K.....17.50
- L.....16.75

If B. B. is omitted deduct \$3.45

No. 2001

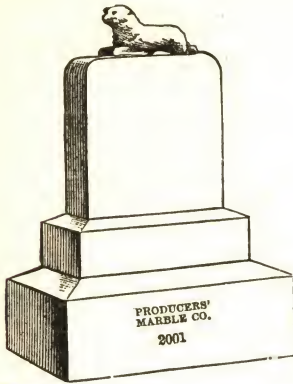

Die.....1.0 x 0.4 x 1.2..0.5
 Base.....1.2 x 0.6 x 0.4..0.2
 B. Base....1.6 x 0.10 x 0.8..0.10
 Weight complete 250 lbs.; no B. B. 100 lbs.

- D.....\$23.00
 - F.....22.50
 - G.....22.25
 - H.....21.75
 - I.....21.50
 - K.....21.25
 - L.....20.75
- If B. B. is omitted deduct \$3.15

No. 2002

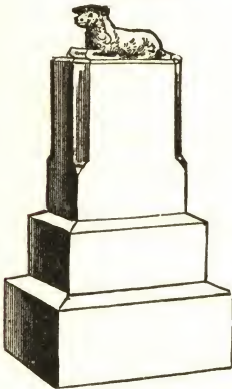

Die.....1.0 x 0.6 x 1.6..0.9
 Base.....1.2 x 0.8 x 0.4..0.3
 B. Base....1.6 x 1.0 x 0.8..1.0
 Weight complete 350 lbs.; no B. B. 170 lbs.

- D.....\$29.75
 - F.....29.25
 - G.....28.75
 - H.....28.25
 - I.....27.75
 - K.....27.00
 - L.....26.25
- If B. B. is omitted deduct \$3.75

No. 2005

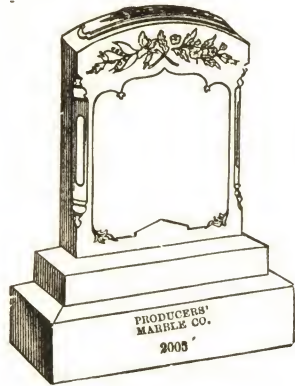

Die.....1.6 x 0.6 x 2.0..1.6
 Base.....1.10 x 0.10 x 0.4..0.6
 B. Base....2.3 x 1.3 x 0.8..1.11
 Weight complete 700 lbs.; no B. B. 355 lbs.

- C.....\$46.75
 - D.....42.25
 - F.....40.25
 - G.....39.25
 - H.....38.25
 - I.....37.25
 - K.....35.75
 - L.....34.25
- If B. B. is omitted deduct \$6.90

No. 2005 1/4

Die.....1.6 x 0.4 x 2.0..1.0
 Base.....1.10 x 0.8 x 0.4..0.5
 B. Base....2.2 x 1.0 x 0.8..1.5
 Weight complete 500 lbs.; no B. B. 245 lbs.

- C.....\$33.50
 - D.....30.25
 - F.....28.75
 - G.....28.00
 - H.....27.25
 - I.....26.75
 - K.....25.50
 - L.....24.50
- If B. B. is omitted deduct \$5.10

No. 2054—A

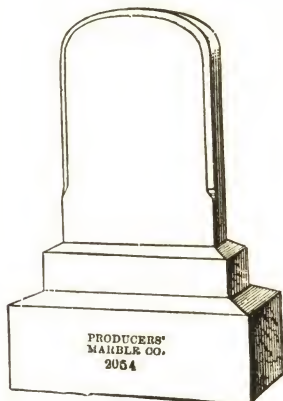

Die.....1.6 x 0.4 x 2. 6..1. 3
 Base.....1.9 x 0.7 x 0. 4..0. 4
 B. Base....2.2 x 1.0 x 0.10..1.10
 Weight complete 600 lbs.; no B. B. 270 lbs.
 C.....\$34.75
 D.....31.25
 F.....29.75
 G.....29.00
 H.....28.00
 I.....27.25
 K.....26.25
 L.....25.00
 If B. B. is omitted deduct \$6.60

No. 2054

Die.....1.6 x 0.4 x 2. 0..1. 0
 Base.....1.9 x 0.7 x 0. 4..0. 4
 B. Base....2.2 x 1.0 x 0.10..1.10
 Weight complete 550 lbs.; no B. B. 220 lbs.
 C.....\$30.75
 D.....27.75
 F.....26.25
 G.....25.75
 H.....25.00
 I.....24.25
 K.....23.25
 L.....22.25
 If B. B. is omitted deduct \$6.60

No. 2054 1/4

Die.....1.4 x 0.4 x 2. 0..0.11
 Base.....1.7 x 0.7 x 0. 4..0. 4
 B. Base....2.0 x 1.0 x 0.10..1. 8
 Weight complete 500 lbs.; no B. B. 200 lbs.
 C.....\$28.75
 D.....26.00
 F.....24.50
 G.....24.00
 H.....23.25
 I.....22.75
 K.....21.75
 L.....20.75
 If B. B. is omitted deduct \$6.00

No. 2063



Die.....1.2 x 0.6 x 1.2..0.8
 Base.....1.4 x 0.8 x 0.4..0.4
 B. Base....1.8 x 1.0 x 0.8..1.1
 Weight complete 320 lbs.; no B. B. 125 lbs.
 C.....\$67.50
 D.....65.00
 F.....64.00
 G.....63.50
 H.....63.00
 I.....62.50
 K.....62.00
 L.....61.00
 If B. B. is omitted deduct \$3.90

No. 2054 1/2

Die.....1. 2 x 0.4 x 1.8..0.8
 Base.....1. 5 x 0.7 x 0.4..0.3
 B. Base....1.10 x 1.0 x 0.8..1.3
 Weight complete 375 lbs.; no B. B. 150 lbs.
 C.....\$22.00
 D.....20.00
 F.....19.00
 G.....18.50
 H.....18.00
 I.....17.75
 K.....17.00
 L.....16.25
 If B. B. is omitted deduct \$4.50

No. 2089

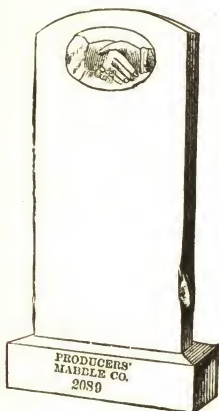

Add to prices of No. 2095 in all grades and thicknesses as follows:

If 1. 4 wide.....	\$ 7.00
" 1. 6 "	8.00
" 1. 8 "	9.25
" 1.10 "	10.50

No. 2092

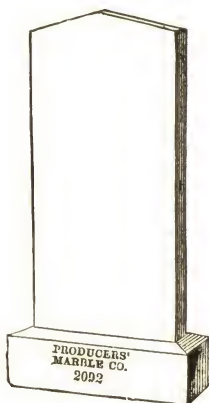

Same sizes and prices as No. 2095.

No. 2090

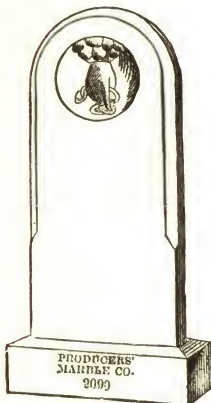

Add to prices of No. 2095 in all grades and thicknesses as follows:

If 1. 4 wide.....	\$11.00
" 1. 6 "	12.00
" 1. 8 "	13.00
" 1.10 "	14.00

No. 2094

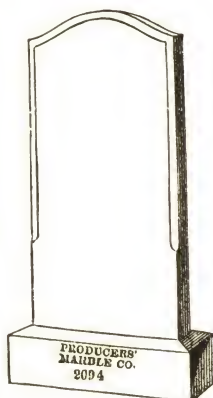

Add to prices of No. 2095 in all grades and thicknesses as follows:

If 1. 4 wide.....	\$5.00
" 1. 6 "	5.75
" 1. 8 "	7.00
" 1.10 "	7.50

No. 2095

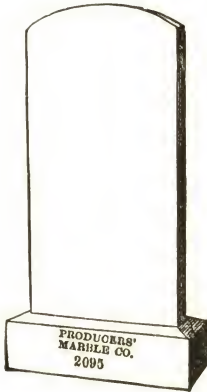

HEADSTONE	C	D	F	G	H	I	K	L
1. 4x0.2x3.0	0.8	\$11.65	\$10.15	\$ 9.50	\$9.15	\$8.85	\$8.50	\$7.50
1. 4x0.3x3.0	1.0	16.50	14.25	13.25	12.75	12.25	11.75	10.25
1. 4x0.4x3.0	1.4	20.65	17.65	16.35	15.65	15.00	14.35	12.35
1. 6x0.2x3.6	0.11	16.05	14.00	13.05	12.60	12.15	11.70	10.30
1. 6x0.3x3.6	1.4	22.00	19.00	17.65	17.00	16.35	15.65	13.65
1. 6x0.4x3.6	1.9	27.15	23.20	21.45	20.55	19.70	18.80	16.20
1. 8x0.2x3.8	1.0	17.50	15.25	14.25	13.75	13.25	12.75	11.25
1. 8x0.3x3.8	1.6	24.75	21.40	19.90	19.15	18.40	17.65	15.40
1. 8x0.4x3.8	2.0	31.00	26.50	24.50	23.50	22.50	21.50	18.50
1.10x0.2x4.0	1.3	21.90	19.05	17.80	17.20	16.55	15.95	14.05
1.10x0.3x4.0	1.10	30.25	26.15	24.30	23.40	22.45	21.50	18.80
1.10x0.4x4.0	2.5	37.45	32.00	29.60	28.40	27.20	26.00	22.35
2. 0x0.4x4.0	2.8	41.35	35.35	32.65	31.35	30.00	28.65	24.65

The above prices cover only the Headstone finished with face, edges and top glossed, back sand rubbed.

For Inferior Bottom Bases, wash-cut, sand rubbed and crated, see page 16.

Mortises

Bottom Bases 1.6 long and smaller, each	\$1.35
Bottom Bases over 1.6 long, each	1.75
Shoulder Tenons, each75
Full Tenons, each	1.25

No. 2098

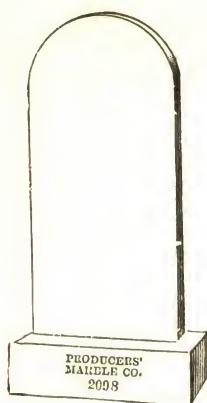

Same sizes and prices as No. 2095.

No. 2102

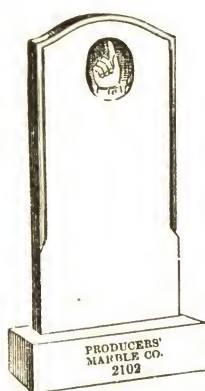

Add to prices of No. 2095 in all grades and thicknesses as follows:

If 1. 4 wide.....	\$11.00
" 1. 6 "	12 00
" 1. 8 "	13.00
" 1.10 "	14.00

No. 2099

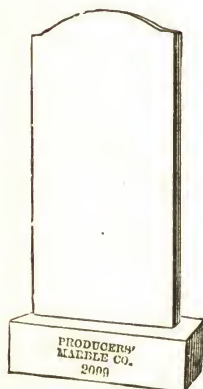

Same sizes and prices as No. 2095.

No. 2104

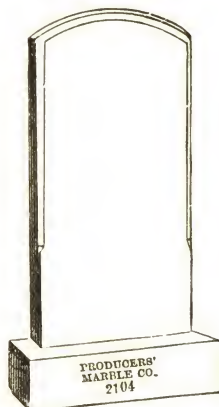

Add to prices of No. 2095 in all grades and thicknesses as follows:

If 1. 4 wide.....	\$2.00
" 1. 6 "	2.50
" 1. 8 "	3.00
" 1.10 "	3.50

No. 2113



Die.....1.0x1.0x1.6..1.6
 Base.....1.1x1.1x0.5..0.6
 B. Base.....1.4x1.4x0.10..1.6
 Weight complete 600 lbs.; no B. B. 330 lbs.

C.....	\$102.00
D.....	98.00
F.....	95.50
G.....	94.50
H.....	93.50
I.....	92.50
K.....	91.00
L.....	89.50

If B. B. is omitted deduct \$5.40

No. 2123

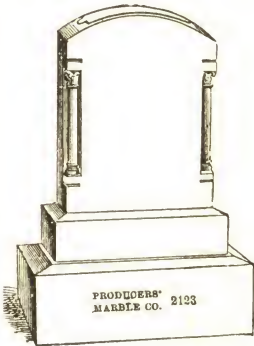

Die.....1.6x0.6x2.0..1.6
 Base.....1.9x0.9x0.5..0.7
 B. Base.....2.2x1.2x0.10..2.1
 Weight complete 700 lbs.; no B. B. 325 lbs.

C.....	\$57.50
D.....	53.00
F.....	51.00
G.....	50.00
H.....	48.75
I.....	47.75
K.....	46.25
L.....	44.75

If B. B. is omitted deduct \$7.50

No. 2154

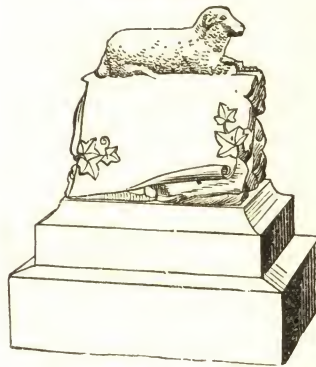

Figure.....1.0x1.0x2.4..2.4
 Die.....1.2x1.2x1.2..1.7
 B. Base.....1.6x1.6x0.10..1.11
 Weight complete 900 lbs.; no B. B. 555 lbs.

C.....	\$201.00
D.....	192.00
F.....	188.00
G.....	186.00
H.....	184.00
I.....	182.00
K.....	179.00
L.....	176.00

If B. B. is omitted deduct \$6.90

No. 2163



Die.....1.0x0.8x1.0..0.8
 Base.....1.3x0.11x0.4..0.5
 B. Base.....1.6x1.2x0.6..0.11
 Weight complete 350 lbs.; no B. B. 185 lbs.

C.....	\$50.50
D.....	48.00
F.....	47.00
G.....	46.50
H.....	45.75
I.....	45.25
K.....	44.50
L.....	43.75

If B. B. is omitted deduct \$3.45

No. 2175



Die.....0.10 x 0.10 x 1.2..0.10
 B. Base....1. 2 x 1. 2 x 0.6..0. 8
 Weight complete 225 lbs.; no B. B. 105 lbs.

D.....	\$34.50
F.....	33.50
G.....	33.25
H.....	32.75
I.....	32.25
K.....	31.75
L.....	31.00

If B. B. is omitted deduct \$2.50

No. 2176

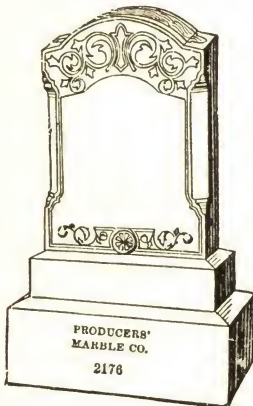

Die.....1.6 x 0.6 x 2. 4..1.9
 Base.....1.9 x 0.9 x 0. 5..0.7
 B. Base.....2.2 x 1.2 x 0.10..2.1
 Weight complete 750 lbs.; no B. B. 375 lbs.

D.....	\$42.50
F.....	40.00
G.....	39.00
H.....	37.75
I.....	36.50
K.....	34.75
L.....	33.00

If B. B. is omitted deduct \$7.50

No. 3150

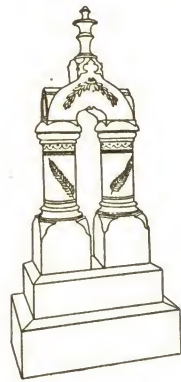

Finial.....0. 6x0. 6x1. 0..0. 3
 Arch.....1. 7x0. 6x1. 1..0.10
 2Caps, Cols. }
 and Dies } 0.10x0.10x2. 6..3. 6
 Base.....2. 3x1. 2x0. 6..1. 4
 B. Base....2. 8x1. 7x0.10..3. 6
 Weight complete 1375 lbs.; no B. B. 745 lbs.

C.....	\$135.00
D.....	122.00
F.....	116.00
G.....	113.00
H.....	110.00
I.....	107.00
K.....	103.00
L.....	98.50

If B. B. is omitted deduct \$12.25

No. 3150 1/4

Finial.....0.5x0. 5x0.10..0. 2
 Arch.....1.3x0. 5x0.11..0. 6
 2 Caps, Cols. }
 and Dies } 0.8x0. 8x2. 4..2. 0
 Base.....1.9x0.11x0. 6..0.10
 B. Base....2.2x1. 4x0. 8..1.11
 Weight complete 850 lbs.; no B. B. 500 lbs.

C.....	\$85.00
D.....	77.00
F.....	74.00
G.....	72.00
H.....	70.50
I.....	68.50
K.....	66.00
L.....	63.50

If B. B. is omitted deduct \$6.90

No. 3151

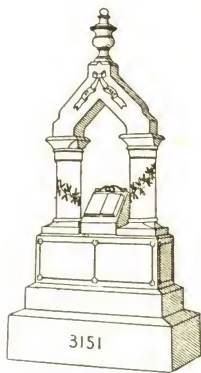

Urn.....	0. 7x0. 7x1.2. .0. 5
Arch.....	2. 2x0. 6x1.6. .1. 8
2 Caps, Cols. and Plinths	} 0.10x0. 10x2.0. .2. 10
Die.....	2. 8x1. 0x1.0. .2. 8
Base.....	3. 0x1. 4x0.6. .2. 0
B. Base.....	3. 6x1. 10x1.0. .6. 5
Book Die.....	0. 9x0. 9x1.0. .0. 7

Weight complete 2900 lbs.; no B.B.1745 lbs.

C.....	\$220.00
D.....	197.00
F.....	187.00
G.....	182.00
H.....	177.00
I.....	172.00
K.....	164.00
L.....	156.00

If B. B. is omitted deduct \$22.45
No Book Die deduct \$13.00

No. 3151¹/₄

Urn.....	0.6x0. 6x1. 0. .0. 3
Arch.....	1. 9x0. 5x1. 3. .0. 11
2 Caps, Cols. and Plinths	} 0.8x0. 8x1.10. .1. 8
Die.....	2.2x0. 10x0.10. .1. 6
Base.....	2.6x1. 2x0. 6. .1. 6
B. Base.....	3.0x1. 8x1. 0. .5. 0
Book Die.....	0.7x0. 7x0.10. .0. 3

Weight complete 1950 lbs.; no B.B.1050 lbs.

C.....	\$152.00
D.....	138.00
F.....	132.00
G.....	129.00
H.....	126.00
I.....	123.00
K.....	118.00
L.....	114.00

If B. B. is omitted deduct \$17.50
No Book Die deduct \$9.50

No. 3152

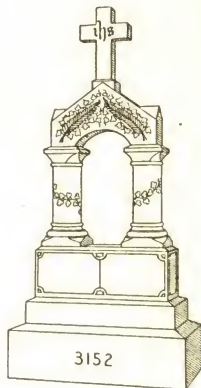

Cross.....	1. 2x0. 5x1.8. .0. 10
Arch.....	2. 6x0.8x1.8. .2. 9
2 Caps, Cols. and Plinths	} 1. 0x1.0x2.4. .4. 8
Die.....	3. 0x1.2x1.2. .4. 1
Base.....	3. 4x1.6x0.8. .3. 4
B. Base.....	3.10x2.0x1.2. .8. 11

C.....	\$378.00
D.....	343.00
F.....	327.00
G.....	319.00
H.....	312.00
I.....	304.00
K.....	292.00
L.....	280.00

If B. B. is omitted deduct \$31.20

No. 3152¹/₄

Cross.....	1. 0x0. 4x1.6. .0. 6
Arch.....	2. 2x0. 6x1.4. .1. 5
2 Caps, Cols. and Plinths	} 0.10x0. 10x2.0. .2. 10
Die.....	2. 8x1. 0x1.0. .2. 8
Base.....	3. 0x1. 4x0.6. .2. 0
B. Base.....	3. 6x1.10x1.0. .6. 5

C.....	\$204.00
D.....	183.00
F.....	173.00
G.....	168.00
H.....	164.00
I.....	159.00
K.....	152.00
L.....	145.00

If B. B. is omitted deduct \$22.45

No. 3152¹/₂

See next page

No. 3175

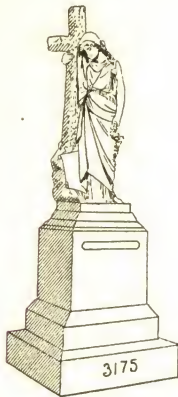

Figure.....6.0 high
 Die.....2.6 x 1.10 x 2.7..11.10
 Base.....3.0 x 2.4 x 1.0..7.0
 B. Base...3.10 x 3.2 x 1.4..16.2

Weight complete 7000 lbs.; no B.B.4090 lbs.

C.....	\$1050.00
D.....	956.00
F.....	914.00
G.....	894.00
H.....	873.00
I.....	853.00
K.....	822.00
L.....	792.00

If B. B. is omitted deduct \$62.60
 Price of Figure in I stock, \$560.00

No. 3177



Cap.....4.10 x 1.4' x 2.4..15.0
 2 Cols....1.2 x 1.2 x 6.0..16.4
 Base.....5.2 x 1.9 1/2 x 1.2..11.1
 Figure...2.0 x 1.10 x 5.8..20.9
 B. Base(S.S)6.8 x 3.2 x 1.0..21.1

Weight complete 12000 lbs.

D.....	\$1582.00
F.....	1518.00
G.....	1487.00
H.....	1455.00
I.....	1424.00
K.....	1400.00
L.....	1375.00

Price of figure in I stock \$600.00

No. 3152 1/2

Cross.....0.10x0.3x1.2..0.3
 Arch.....1.9x0.5x1.2..0.10
 2 Caps, Cols. and Plinths } 0.8x0.8x1.10..1.8
 Die.....2.2x0.10x0.10..1.6
 Base.....2.6x1.2x0.6..1.6
 B. Base....3.0x1.8x1.0..5.0

C.....	\$141.00
D.....	128.00
F.....	122.00
G.....	119.00
H.....	116.00
I.....	114.00
K.....	109.00
L.....	105.00

If B. B. is omitted deduct \$17.50

No. 3254 1/2

Plinth....0.7x0.7x0.6..0.2
 Cap.....1.3x1.3x0.10..1.4
 Die.....1.0x1.0x2.6..2.6
 Base.....1.4x1.4x0.8..1.2
 B. Base....1.10x1.10x1.0..3.4

Weight complete 1450 lbs.; no B. B. 850 lbs.

C.....	\$104.00
D.....	92.00
F.....	87.00
G.....	84.50
H.....	82.00
I.....	79.50
K.....	75.50
L.....	71.50

If B. B. is omitted deduct \$11.65

No. 3203¹/₄



Urn.....	0.	8 x 0.	8 x 1.	4.	0.7
Plinth.....	0.	8 x 0.	8 x 0.	4.	0.2
Cap.....	1.	5 x 1.	5 x 0.10.		1.8
Die.....	1.	2 x 1.	2 x 2.	6.	3.5
Base.....	1.	6 x 1.	6 x 0.	8.	1.6
Base.....	1.	10 x 1.	10 x 0.	6.	1.8
B. Base....	2.	4 x 2.	4 x 1.	0.	5.5

Weight complete 2450 lbs.; no B.B.1475 lbs.

C.....	\$185.00
D.....	165.00
F.....	156.00
G.....	151.00
H.....	147.00
I.....	142.00
K.....	135.00
L.....	129.00

If B. B. is omitted deduct \$18.95
If polished entire add \$7.75

No. 3203¹/₂

Urn.....	0.7 x 0.7 x 1.	2.	0.5
Plinth.....	0.7 x 0.7 x 0.	4.	0.1
Cap.....	1.3 x 1.3 x 0.10.		1.4
Die.....	1.0 x 1.0 x 2.	4.	2.4
Base.....	1.4 x 1.4 x 0.	8.	1.2
Base.....	1.7 x 1.7 x 0.	6.	1.3
B. Base....	2.2 x 2.2 x 1.	0.	4.8

Weight complete 1950 lbs.; no B.B.1110 lbs.

C.....	\$146.00
D.....	131.00
F.....	125.00
G.....	121.00
H.....	118.00
I.....	115.00
K.....	110.00
L.....	105.00

If B. B. is omitted deduct \$16.35
If polished entire add \$7.25

No. 3254

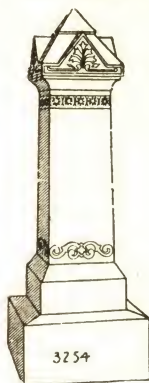

Plinth.....	0.10 x 0.10 x 0.	8.	0.6
Cap.....	1.7 x 1.7 x 1.	0.	2.6
Die.....	1.4 x 1.4 x 3.	0.	5.4
Base.....	1.9 x 1.9 x 0.10.		2.7
B. Base....	2.4 x 2.4 x 1.	2.	6.4

Weight complete 3000 lbs.; no B.B.1860 lbs.

C.....	\$205.00
D.....	180.00
F.....	170.00
G.....	164.00
H.....	159.00
I.....	153.00
K.....	145.00
L.....	137.00

If B. B. is omitted deduct \$22.15

No. 3254¹/₄

Plinth.....	0.8 x 0.8 x 0.	7.	0.3
Cap.....	1.5 x 1.5 x 1.	0.	2.0
Die.....	1.2 x 1.2 x 2.10.		3.10
Base.....	1.7 x 1.7 x 0.10.		2.1
B. Base....	2.2 x 2.2 x 1.	2.	5.6

Weight complete 2350 lbs.; no B.B.1260 lbs.

C.....	\$161.00
D.....	143.00
F.....	135.00
G.....	131.00
H.....	127.00
I.....	123.00
K.....	117.00
L.....	110.00

If B. B. is omitted deduct \$19.25

No. 3254¹/₂

See previous page

No. 3263

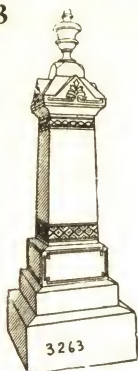

Urn.....	0.9 x 0.9 x 1.6	.0 10
Plinth.....	0.9 x 0.9 x 0.4	.0 2
Cap.....	1.7 x 1.7 x 1.0	.2 6
Die.....	1.4 x 1.4 x 3.0	.5 4
Base.....	1.8 x 1.8 x 0.8	.1 10
Base.....	2.0 x 2.0 x 0.6	.2 0
B. Base.....	2.6 x 2.6 x 1.2	.7 4

Weight complete 3300 lbs.; no B.B.1980 lbs.

D.....	\$211.00
G.....	192.00
H.....	186.00
I.....	180.00
K.....	170.00
L.....	161.00

If B. B. is omitted deduct \$25.65.

No. 3263 $\frac{1}{4}$

Urn.....	0.8 x 0.8 x 1.4	.0 7
Plinth.....	0.8 x 0.8 x 0.4	.0 2
Cap.....	1.5 x 1.5 x 0.10	.1 8
Die.....	1.2 x 1.2 x 2.8	.3 8
Base.....	1.6 x 1.6 x 0.8	.1 6
Base.....	1.10 x 1.10 x 0.6	.1 8
B. Base.....	2.4 x 2.4 x 1.0	.5 5

Weight complete 2500 lbs.; no B.B.1525 lbs.

D.....	\$157.00
G.....	143.00
H.....	138.00
I.....	134.00
K.....	127.00
L.....	120.00

If B. B. is omitted deduct \$18.95.

No. 3263 $\frac{1}{2}$

Urn.....	0.7 x 0.7 x 1.2	.0 5
Plinth.....	0.7 x 0.7 x 0.4	.0 1
Cap.....	1.3 x 1.3 x 0.10	.1 4
Die.....	1.0 x 1.0 x 2.6	.2 6
Base.....	1.4 x 1.4 x 0.8	.1 2
Base.....	1.7 x 1.7 x 0.6	.1 3
B. Base.....	2.2 x 2.2 x 1.0	.4 8

Weight complete 1950 lbs.; no B.B.1110 lbs.

D.....	\$120.00
G.....	110.00
H.....	107.00
I.....	104.00
K.....	98.00
L.....	93.00

If B. B. is omitted deduct \$16.35

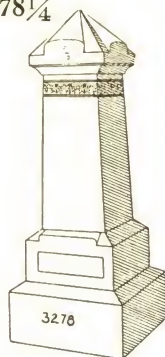
No. 3278 $\frac{1}{4}$ 

Cap.....	1.7 x 1.7 x 1.4	.3 4
Die.....	1.4 x 1.4 x 3.0	.5 4
Base.....	1.10 x 1.10 x 1.0	.3 4
B. Base.....	2.6 x 2.6 x 1.4	.8 4

Weight complete 3500 lbs.; no B.B.2000 lbs.

C.....	\$226.00
D.....	199.00
F.....	187.00
G.....	181.00
H.....	175.00
I.....	169.00
K.....	160.00
L.....	151.00

If B. B. is omitted deduct \$29.15

No. 3278 $\frac{1}{2}$

Cap.....	1.5 x 1.5 x 1.3	.2 6
Die.....	1.2 x 1.2 x 2.10	.3 10
Base.....	1.7 x 1.7 x 1.0	.2 6
B. Base.....	2.2 x 2.2 x 1.2	.5 6

Weight complete 2400 lbs.; no B.B.1410 lbs.

C.....	\$169.00
D.....	149.00
F.....	141.00
G.....	136.00
H.....	132.00
I.....	127.00
K.....	121.00
L.....	114.00

If B. B. is omitted deduct \$19.25

No. 3278 $\frac{3}{4}$

Cap.....	1.3 x 1.3 x 1.1	.1 8
Die.....	1.0 x 1.0 x 2.8	.2 8
Base.....	1.5 x 1.5 x 0.10	.1 8
B. Base.....	2.0 x 2.0 x 1.2	.4 8

Weight complete 1750 lbs.; no B.B. 910 lbs.

C.....	\$118.00
D.....	104.00
F.....	98.00
G.....	95.00
H.....	92.00
I.....	89.00
K.....	84.50
L.....	80.00

If B. B. is omitted deduct \$16.35

No. 3279

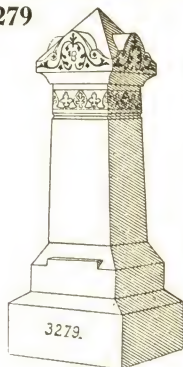

Cap.....	1. 7 x 1. 7 x 1.4 . . . 3.4
Die.....	1. 4 x 1. 4 x 3.0 . . . 5.4
Base.....	1.10 x 1.10 x 1.0 . . . 3.4
B. Base....	2. 4 x 2. 4 x 1.4 . . . 7.3
Weight complete 3300 lbs.; no B.B.1995 lbs.	
C.....	\$223.00
D.....	196.00
F.....	184.00
G.....	178.00
H.....	172.00
I.....	166.00
K.....	157.00
L.....	148.00
If B. B. is omitted deduct \$25.40	

No. 3279¹/₄

Cap.....	1.5 x 1.5 x 1. 2 . . . 2. 4
Die.....	1.2 x 1.2 x 2.10 . . . 3.10
Base.....	1.7 x 1.7 x 0.10 . . . 2. 1
B. Base....	2.2 x 2.2 x 1. 2 . . . 5. 6
Weight complete 2350 lbs.; no B.B.1360 lbs.	
C.....	\$161.00
D.....	142.00
F.....	134.00
G.....	130.00
H.....	126.00
I.....	122.00
K.....	115.00
L.....	109.00
If B. B. is omitted deduct \$19.25	

No. 3279¹/₂

Cap.....	1. 3 x 1. 3 x 1. 0 . . . 1.7
Die.....	1. 0 x 1. 0 x 2. 8 . . . 2.8
Base.....	1. 5 x 1. 5 x 0.10 . . . 1.8
B. Base....	1.10 x 1.10 x 1. 0 . . . 3.4
Weight complete 1500 lbs.; no B. B. 900 lbs.	
C.....	\$117.00
D.....	104.00
F.....	98.00
G.....	95.00
H.....	92.00
I.....	89.00
K.....	85.00
L.....	80.00
If B. B. is omitted deduct \$11.65	

No. 3287

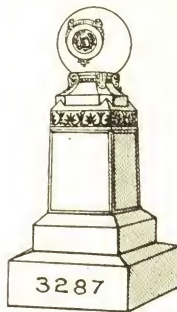

Ball.....	1.3 x 1.3 x 1. 3 . . . 1.11
Die.....	1.4 x 1.4 x 3. 0 . . . 5. 4
Base.....	1.9 x 1.9 x 0.10 . . . 2. 7
B. Base....	2.3 x 2.3 x 1. 2 . . . 5.11
Weight complete 2750 lbs.; no B.B.1685 lbs.	
D.....	\$165.00
F.....	155.00
G.....	150.00
H.....	145.00
I.....	140.00
K.....	133.00
L.....	126.00
If B. B. is omitted deduct \$20.70.	
For carved emblem add \$5.00.	

No. 3287¹/₄

Ball.....	1.1 x 1.1 x 1. 1 . . . 1. 3
Die.....	1.2 x 1.2 x 2.10 . . . 3.10
Base.....	1.6 x 1.6 x 0. 8 . . . 1. 6
B. Base....	2.0 x 2.0 x 1. 2 . . . 4. 8
Weight complete 1980 lbs.; no B.B.1140 lbs.	
D.....	\$127.00
F.....	121.00
G.....	117.00
H.....	114.00
I.....	111.00
K.....	106.00
L.....	101.00
If B. B. is omitted deduct \$16.35	
For carved emblem add \$5.00	

No. 3287¹/₂

Ball.....	0.11 x 0.11 x 0.11 . . . 0.9
Die.....	1. 0 x 1. 0 x 2. 8 . . . 2.8
Base.....	1. 4 x 1. 4 x 0. 8 . . . 1.2
B. Base....	1.10 x 1.10 x 1. 0 . . . 3.4
Weight complete 1440 lbs.; no B. B. 840 lbs.	
D.....	\$94.50
F.....	90.00
G.....	88.00
H.....	85.50
I.....	83.50
K.....	80.00
L.....	76.50
If B. B. is omitted deduct \$11.65	
For carved emblem add \$5.00	

No. 3288

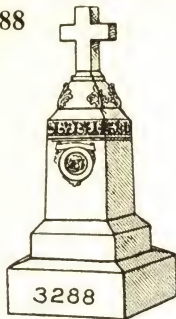

Cross.....	1.2 x 0.5 x 1.10	.0.11
Plinth.....	1.0 x 1.0 x 0.8	.0.8
Die.....	1.4 x 1.4 x 2.8	.4.9
Base.....	1.9 x 1.9 x 0.10	.2.7
B. Base.....	2.3 x 2.3 x 1.2	.5.11
Weight complete 2550 lbs.; no B.B.1485 lbs.		

C.....	\$179.00
D.....	158.00
F.....	150.00
G.....	145.00
H.....	141.00
I.....	136.00
K.....	129.00
L.....	123.00
If B. B. is omitted deduct \$20.70	
For carved emblem add \$5.00	

No. 3288¹/₄

Cross.....	1.0 x 0.4 x 1.6	.0.6
Plinth.....	0.11 x 0.11 x 0.7	.0.6
Die.....	1.2 x 1.2 x 2.6	.3.5
Base.....	1.6 x 1.6 x 0.8	.1.6
B. Base.....	2.0 x 2.0 x 1.2	.4.8
Weight complete 1850 lbs.; no B.B.1010 lbs.		

C.....	\$135.00
D.....	122.00
F.....	116.00
G.....	113.00
H.....	110.00
I.....	107.00
K.....	103.00
L.....	98.00
If B. B. is omitted deduct \$16.35	
For carved emblem add \$5.00	

No. 3288¹/₂

Cross.....	0.10 x 0.4 x 1.4	.0.4
Plinth.....	0.8 x 0.8 x 0.6	.0.3
Die.....	1.0 x 1.0 x 2.4	.2.4
Base.....	1.4 x 1.4 x 0.8	.1.2
B. Base.....	1.10 x 1.10 x 1.0	.3.4
Weight complete 1300 lbs.; no B. B. 700 lbs.		

C.....	\$100.00
D.....	91.00
F.....	87.00
G.....	85.00
H.....	83.00
I.....	81.00
K.....	78.00
L.....	74.50
If B. B. is omitted deduct \$11.65	
For carved emblem add \$5.00	

No. 3294

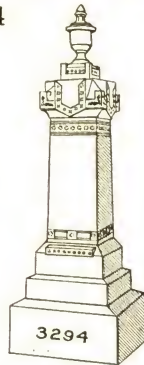

Urn.....	0.9 x 0.9 x 1.6	.0.10
Plinth.....	0.10 x 0.10 x 0.4	.0.3
Cap.....	1.7 x 1.7 x 1.0	.2.6
Die.....	1.4 x 1.4 x 3.0	.5.4
Base.....	1.8 x 1.8 x 0.10	.2.4
Base.....	2.0 x 2.0 x 0.6	.2.0
B. Base.....	2.6 x 2.6 x 1.2	.7.4
Weight complete 3500 lbs.; no B.B.2180 lbs.		

D.....	\$226.00
G.....	206.00
H.....	199.00
I.....	193.00
K.....	183.00
L.....	173.00
If B. B. is omitted deduct \$25.65.	

No. 3294¹/₄

Urn.....	0.8 x 0.8 x 1.4	.0.7
Plinth.....	0.8 x 0.8 x 0.4	.0.2
Cap.....	1.5 x 1.5 x 0.10	.1.8
Die.....	1.2 x 1.2 x 2.10	.3.10
Base.....	1.6 x 1.6 x 0.8	.1.6
Base.....	1.10 x 1.10 x 0.6	.1.8
B. Base.....	2.4 x 2.4 x 1.0	.5.5
Weight complete 2600 lbs.; no B.B.1625 lbs.		

D.....	\$168.00
G.....	154.00
H.....	149.00
I.....	144.00
K.....	137.00
L.....	130.00
If B. B. is omitted deduct \$18.95	

No. 3294¹/₂

Urn.....	0.7 x 0.7 x 1.2	.0.5
Plinth.....	0.7 x 0.7 x 0.4	.0.1
Cap.....	1.3 x 1.3 x 0.10	.1.4
Die.....	1.0 x 1.0 x 2.6	.2.6
Base.....	1.4 x 1.4 x 0.8	.1.2
Base.....	1.7 x 1.7 x 0.6	.1.3
B. Base.....	2.0 x 2.0 x 1.0	.4.0
Weight complete 1900 lbs.; no B.B.1180 lbs.		

D.....	\$127.00
G.....	117.00
H.....	114.00
I.....	111.00
K.....	105.00
L.....	100.00
If B. B. is omitted deduct \$14.00	

No. 3295

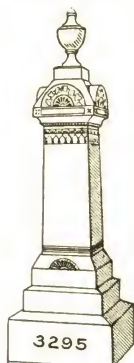

Urn.....0.9x0.9x1.6..0.10
 Plinth.....0.9x0.9x0.4..0.2
 Cap.....1.7x1.7x1.2..2.11
 Die.....1.4x1.4x3.0..5.4
 Base.....1.8x1.8x0.10..2.4
 Base.....2.0x2.0x0.6..2.0
 B. Base.....2.6x2.6x1.2..7.4
 Weight complete 3600 lbs.; no B.B.2280 lbs.
 D.....\$227.00
 G.....206.00
 H.....200.00
 I.....193.00
 K.....183.00
 L.....172.00
 If B. B. is omitted deduct \$25.65

No. 3295¹/₄

Urn.....0.8x0.8x1.4..0.7
 Plinth...0.8x0.8x0.4..0.2
 Cap.....1.5x1.5x1.0..2.0
 Die.....1.2x1.2x2.10..3.10
 Base.....1.6x1.6x0.8..1.6
 Base.....1.10x1.10x0.6..1.8
 B. Base...2.4x2.4x1.0..5.5
 Weight complete 2600 lbs.; no B.B.1625 lbs.
 D.....\$169.00
 G.....154.00
 H.....149.00
 I.....145.00
 K.....137.00
 L.....130.00
 If B. B. is omitted deduct \$18.95

No. 3295¹/₂

Urn.....0.7x0.7x1.2..0.5
 Plinth.....0.7x0.7x0.4..0.1
 Cap.....1.3x1.3x0.10..1.4
 Die.....1.0x1.0x2.6..2.6
 Base.....1.5x1.5x0.8..1.4
 Base.....1.7x1.7x0.6..1.3
 B. Base.....2.0x2.0x1.0..4.0
 Weight complete 1900 lbs.; no B.B.1180 lbs.
 D.....\$122.00
 G.....112.00
 H.....109.00
 I.....105.00
 K.....100.00
 L.....95.00
 If B. B. is omitted deduct \$14.00

No. 3296

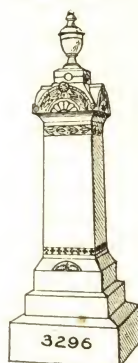

Urn.....0.9x0.9x1.6..0.10
 Plinth.....0.9x0.9x0.4..0.2
 Cap.....1.7x1.7x1.0..2.6
 Die.....1.4x1.4x3.0..5.4
 Base.....1.8x1.8x0.10..2.4
 Base.....2.0x2.0x0.6..2.0
 B. Base.....2.6x2.6x1.2..7.4
 Weight complete 3550 lbs.; no B.B.2230 lbs.
 D.....\$225.00
 G.....205.00
 H.....198.00
 I.....192.00
 K.....182.00
 L.....172.00
 If B. B. is omitted deduct \$25.65

No. 3296¹/₄

Urn.....0.8x0.8x1.4..0.7
 Plinth...0.8x0.8x0.4..0.2
 Cap.....1.5x1.5x0.10..1.8
 Die.....1.2x1.2x2.10..3.10
 Base.....1.6x1.6x0.8..1.6
 Base.....1.10x1.10x0.6..1.8
 B. Base...2.4x2.4x1.0..5.5
 Weight complete 2550 lbs.; no B.B.1575 lbs.
 D.....\$165.00
 G.....151.00
 H.....146.00
 I.....141.00
 K.....134.00
 L.....127.00
 If B. B. is omitted deduct \$18.95

No. 3296¹/₂

Urn.....0.7x0.7x1.2..0.5
 Plinth.....0.7x0.7x0.4..0.1
 Cap.....1.3x1.3x0.10..1.4
 Die.....1.0x1.0x2.6..2.6
 Base.....1.4x1.4x0.8..1.2
 Base.....1.7x1.7x0.6..1.3
 B. Base.....2.0x2.0x1.0..4.0
 Weight complete 1900 lbs.; no B.B.1180 lbs.
 D.....\$126.00
 G.....116.00
 H.....113.00
 I.....110.00
 K.....104.00
 L.....99.00
 If B. B. is omitted deduct \$14.00

No. 3297

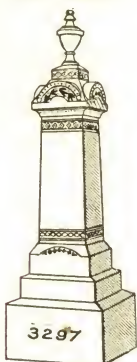

Urn.....	0.9 x 0.9 x 1.6	.0.10
Plinth.....	0.9 x 0.9 x 0.4	.0.2
Cap.....	1.7 x 1.7 x 1.0	.2.6
Die.....	1.4 x 1.4 x 3.0	.5.4
Base.....	1.8 x 1.8 x 0.10	.2.4
Base.....	2.0 x 2.0 x 0.6	.2.0
B. Base.....	2.6 x 2.6 x 1.2	.7.4

Weight complete 3550 lbs.; no B.B.2230 lbs.

D.....	\$223.00
G.....	203.00
H.....	196.00
I.....	190.00
K.....	180.00
L.....	170.00

If B. B. is omitted deduct \$25.65

No. 3297¹/₄

Urn.....	0.8 x 0.8 x 1.4	.0.7
Plinth.....	0.8 x 0.8 x 0.4	.0.2
Cap.....	1.5 x 1.5 x 0.10	.1.8
Die.....	1.2 x 1.2 x 2.10	.3.10
Base.....	1.6 x 1.6 x 0.8	.1.6
Base.....	1.10 x 1.10 x 0.6	.1.8
B. Base.....	2.4 x 2.4 x 1.0	.5.5

Weight complete 2550 lbs.; no B.B.1575 lbs.

D.....	\$164.00
G.....	150.00
H.....	145.00
I.....	140.00
K.....	133.00
L.....	126.00

If B. B. is omitted deduct \$18.95

No. 3297¹/₂

Urn.....	0.7 x 0.7 x 1.2	.0.5
Plinth.....	0.7 x 0.7 x 0.4	.0.1
Cap.....	1.3 x 1.3 x 0.10	.1.4
Die.....	1.0 x 1.0 x 2.6	.2.6
Base.....	1.4 x 1.4 x 0.8	.1.2
Base.....	1.7 x 1.7 x 0.6	.1.3
B. Base.....	2.0 x 2.0 x 1.0	.4.0

Weight complete 1900 lbs.; no B.B.1180 lbs.

D.....	\$122.00
G.....	112.00
H.....	109.00
I.....	106.00
K.....	100.00
L.....	95.00

If B. B. is omitted deduct \$14.00

No. 3302

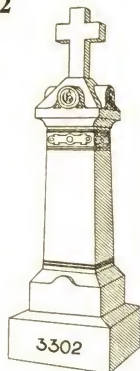

Cross.....	1.2 x 0.5 x 1.8	.0.10
Cap.....	1.7 x 1.7 x 1.0	.2.6
Die.....	1.4 x 1.4 x 3.0	.5.4
Base.....	1.10 x 1.10 x 1.0	.3.4
B. Base.....	2.4 x 2.4 x 1.4	.7.3

Weight complete 3300 lbs.; no B.B.1995 lbs.

D.....	199.00
G.....	181.00
H.....	175.00
I.....	169.00
K.....	160.00
L.....	151.00

If B. B. is omitted deduct \$25.40

No. 3302¹/₄

Cross.....	1.0 x 0.4 x 1.6	.0.6
Cap.....	1.5 x 1.5 x 1.0	.2.0
Die.....	1.2 x 1.2 x 2.10	.3.10
Base.....	1.7 x 1.7 x 0.10	.2.1
B. Base.....	2.2 x 2.2 x 1.2	.5.6

Weight complete 2400 lbs.; no B.B.1410 lbs.

D.....	\$144.00
G.....	132.00
H.....	129.00
I.....	123.00
K.....	117.00
L.....	111.00

If B. B. is omitted deduct \$19.25

No. 3302¹/₂

Cross.....	0.10 x 0.3 x 1.2	.0.3
Cap.....	1.3 x 1.3 x 0.10	.1.4
Die.....	1.0 x 1.0 x 2.6	.2.6
Base.....	1.5 x 1.5 x 0.10	.1.8
B. Base.....	1.10 x 1.10 x 1.0	.3.4

Weight complete 1600 lbs.; no B.B.1000 lbs.

D.....	\$107.00
G.....	98.50
H.....	95.50
I.....	92.50
K.....	88.00
L.....	84.00

If B. B. is omitted deduct \$11.65.

No. 3303



Urn.....0. 9 x 0. 9 x 1.6 .0.10
 Cap.....1. 7 x 1. 7 x 1.0 .2. 6
 Die.....1. 4 x 1. 4 x 3.0 .5. 4
 Base.....1.10 x 1.10 x 1.0 .3. 4
 B. Base...2. 4 x 2. 4 x 1.4 .7. 3
 Weight complete 3300 lbs.; no B.B.1995 lbs.
 C.....\$226.00
 D.....199.00
 F.....187.00
 G.....181.00
 H.....175.00
 I.....169.00
 K.....160.00
 L.....151.00
 If B. B. is omitted deduct \$25.40

No. 3303¹/₄

Urn.....0.8 x 0.8 x 1. 4 .0. 7
 Cap.....1.5 x 1.5 x 1. 0 .2. 0
 Die.....1.2 x 1.2 x 2.10 .3.10
 Base.....1.7 x 1.7 x 0.10 .2. 1
 B. Base...2.2 x 2.2 x 1. 2 .5. 6
 Weight complete 2400 lbs.; no B.B.1410 lbs.
 C.....\$163.00
 D.....144.00
 F.....136.00
 G.....132.00
 H.....127.00
 I.....123.00
 K.....117.00
 L.....110.00
 If B. B. is omitted deduct \$19.25

No. 3303¹/₂

Urn.....0. 7 x 0. 7 x 1. 2 .0.5
 Cap.....1. 3 x 1. 3 x 0.10 .1. 4
 Die.....1. 0 x 1. 0 x 2. 6 .2. 6
 Base.....1. 5 x 1. 5 x 0.10 .1.8
 B. Base...1.10 x 1.10 x 1. 0 .3.4
 Weight complete 1600 lbs.; no B.B.1000 lbs.
 C.....\$120.00
 D.....107.00
 F.....101.00
 G.....98.00
 H.....95.00
 I.....92.00
 K.....87.50
 L.....83.50
 If B. B. is omitted deduct \$11.65

No. 3306

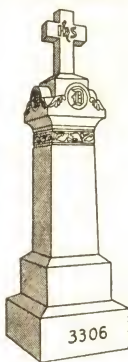

Cross.....1.2 x 0.5 x 1.8 .0.10
 Cap.....1.7 x 1.7 x 1.4 .3. 4
 Die.....1.4 x 1.4 x 3.0 .5. 4
 Base.....1.9 x 1.9 x 1.0 .3. 1
 B. Base...2.4 x 2.4 x 1.2 .6. 4
 Weight complete 3200 lbs.; no B.B.2060 lbs.
 D.....\$206.00
 F.....194.00
 G.....187.00
 H.....181.00
 I.....175.00
 K.....165.00
 L.....156.00
 If B. B. is omitted deduct \$22.15

No. 3306¹/₄

Cross.....1.0 x 0.4 x 1. 6 .0. 6
 Cap.....1.5 x 1.5 x 1. 2 .2. 4
 Die.....1.2 x 1.2 x 2.10 .3.10
 Base.....1.7 x 1.7 x 1. 0 .2. 6
 B. Base...2.2 x 2.2 x 1. 0 .4. 8
 Weight complete 2200 lbs.; no B.B.1360 lbs.
 D.....\$157.00
 F.....147.00
 G.....143.00
 H.....138.00
 I.....134.00
 K.....127.00
 L.....120.00
 If B. B. is omitted deduct \$16.35

No. 3306¹/₂

Cross.....0.10 x 0.3 x 1. 2 .0.3
 Cap.....1. 3 x 1.3 x 1. 0 .1.7
 Die.....1. 0 x 1.0 x 2. 6 .2.6
 Base.....1. 5 x 1.5 x 0.10 .1.8
 B. Base...2. 0 x 2.0 x 1. 0 .4.0
 Weight complete 1750 lbs.; no B.B.1030 lbs.
 D.....\$115.00
 F.....109.00
 G.....106.00
 H.....103.00
 I.....100.00
 K.....95.50
 L.....91.00
 If B. B. is omitted deduct \$14.00

No. 3317

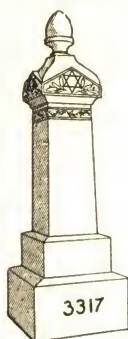

Fin.....	0.9 x 0.9 x 1.2	.0.8
Cap.....	1.7 x 1.7 x 1.4	.3.4
Die.....	1.4 x 1.4 x 3.0	.5.4
Base.....	1.9 x 1.9 x 1.0	.3.1
B. Base.....	2.4 x 2.4 x 1.2	.6.4

Weight complete 3300 lbs.; no B. B. 2160 lbs.

D.....	\$188.00
F.....	176.00
G.....	170.00
H.....	163.00
I.....	157.00
K.....	148.00
L.....	139.00

If B. B. is omitted deduct \$22.15

No. 3318

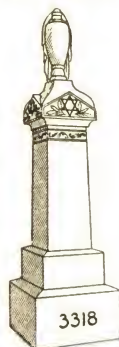

Urn.....	0.9 x 0.9 x 2.0	.1.2
Cap.....	1.7 x 1.7 x 1.4	.3.4
Die.....	1.4 x 1.4 x 3.0	.5.4
Base.....	1.9 x 1.9 x 1.0	.3.1
B. Base.....	2.4 x 2.4 x 1.2	.6.4

Weight complete 3400 lbs.; no B. B. 2260 lbs.

D.....	\$218.00
G.....	199.00
H.....	193.00
I.....	186.00
K.....	176.00
L.....	167.00

If B. B. is omitted deduct \$22.15

No. 3317 $\frac{1}{4}$

Fin.....	0.8 x 0.8 x 1.1	.0.6
Cap.....	1.5 x 1.5 x 1.2	.2.4
Die.....	1.2 x 1.2 x 2.10	.3.10
Base.....	1.7 x 1.7 x 0.10	.2.1
B. Base.....	2.2 x 2.2 x 1.2	.5.6

Weight complete 2500 lbs.; no B. B. 1500 lbs.

D.....	\$145.00
F.....	137.00
G.....	132.00
H.....	128.00
I.....	124.00
K.....	117.00
L.....	110.00

If B. B. is omitted deduct \$19.25

No. 3318 $\frac{1}{4}$

Urn.....	0.8 x 0.8 x 1.10	.0.10
Cap.....	1.5 x 1.5 x 1.2	.2.4
Die.....	1.2 x 1.2 x 2.10	.3.10
Base.....	1.7 x 1.7 x 0.10	.2.1
B. Base.....	2.2 x 2.2 x 1.0	.4.8

Weight complete 2550 lbs.; no B. B. 1700 lbs.

D.....	\$168.00
G.....	154.00
H.....	149.00
I.....	145.00
K.....	138.00
L.....	131.00

If B. B. is omitted deduct \$16.35

No. 3317 $\frac{1}{2}$

Fin.....	0.7 x 0.7 x 1.0	.0.4
Cap.....	1.3 x 1.3 x 1.0	.1.7
Die.....	1.0 x 1.0 x 2.6	.2.6
Base.....	1.5 x 1.5 x 0.10	.1.8
B. Base.....	2.0 x 2.0 x 1.0	.4.0

Weight complete 1750 lbs.; no B. B. 1030 lbs.

D.....	\$108.00
F.....	102.00
G.....	99.00
H.....	96.00
I.....	93.00
K.....	88.50
L.....	83.50

If B. B. is omitted deduct \$14.00

No. 3318 $\frac{1}{2}$

Urn.....	0.7 x 0.7 x 1.8	.0.7
Cap.....	1.3 x 1.3 x 1.0	.1.7
Die.....	1.0 x 1.0 x 2.6	.2.6
Base.....	1.5 x 1.5 x 0.10	.1.8
B. Base.....	2.0 x 2.0 x 1.0	.4.0

Weight complete 1800 lbs.; no B. B. 1080 lbs.

D.....	\$128.00
G.....	119.00
H.....	117.00
I.....	112.00
K.....	108.00
L.....	103.00

If B. B. is omitted deduct \$14.00

No. 3418

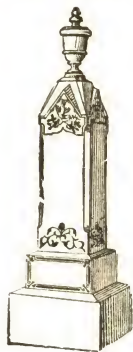

Urn.....0.8x0.8x1.6..0.8
 Die.....1.2x1.2x3.4..4.6
 Base.....1.6x1.6x0.10..1.11
 B. Base....2.0x2.0x1.2..4.8
 Weight complete 2000 lbs.; no B.B.1160 lbs.

- C.....\$144.00
- D.....129.00
- F.....121.00
- G.....118.00
- H.....114.00
- I.....111.00
- K.....106.00
- L.....100.00

If B. B. is omitted deduct \$16.35

No. 3418¹/₄

Urn.....0.7x0.7x1.4..0.5
 Die.....1.0x1.0x3.2..3.2
 Base.....1.4x1.4x0.8..1.2
 B. Base....1.10x1.10x1.0..3.4
 Weight complete 1400 lbs.; no B.B. 800 lbs.

- C.....\$102.00
- D.....91.00
- F.....86.00
- G.....84.00
- H.....81.50
- I.....79.00
- K.....75.50
- L.....72.00

If B. B. is omitted deduct \$11.65

No. 3418¹/₂

Urn.....0.6x0.6x1.0..0.3
 Die.....0.10x0.10x2.10..2.0
 Base.....1.2x1.2x0.8..0.11
 B. Base....1.6x1.6x0.10..1.11
 Weight complete 900 lbs.; no B. B. 550 lbs.

- C.....\$67.50
- D.....60.50
- F.....57.50
- G.....56.00
- H.....54.50
- I.....52.50
- K.....50.50
- L.....48.00

If B. B. is omitted deduct \$6.90

No. 3437

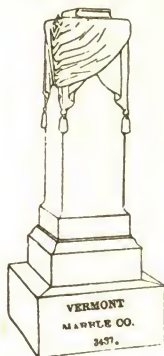

Die.....1.2x1.2x3.6..4.9
 Base.....1.6x1.6x0.8..1.6
 B. Base....2.0x2.0x1.0..4.0

Weight complete 1650 lbs.; no B. B. 930 lbs.

- C.....\$182.00
- D.....168.00
- F.....162.00
- G.....159.00
- H.....156.00
- I.....153.00
- K.....148.00
- L.....143.00

If B. B. is omitted deduct \$14.00

No. 3460³/₄

Urn.....0.5x0.5x0.9..0.2
 Die.....0.8x0.8x2.4..1.0
 Base.....1.0x1.0x0.6..0.6
 B. Base....1.4x1.4x0.8..1.2

Weight complete 500 lbs.; no B. B. 300 lbs.

- C.....\$41.25
- D.....37.50
- F.....36.00
- G.....35.00
- H.....34.25
- I.....33.50
- K.....32.25
- L.....31.00

If B. B. is omitted deduct \$4.20

No. 3441

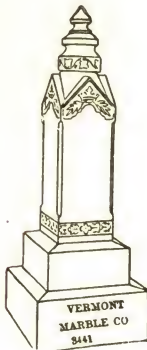

Die.....	0.10 x 0.10 x 3.0	.2.1
Base.....	1.2 x 1.2 x 0.8	.0.11
B. Base.....	1.6 x 1.6 x 0.10	.1.11
Weight complete 800 lbs.; no B. B. 450 lbs.		
C.....		\$60.50
D.....		53.50
F.....		50.50
G.....		49.00
H.....		47.50
I.....		46.00
K.....		43.75
L.....		41.50
If B. B. is omitted deduct \$6.90		

No. 3441 $\frac{1}{4}$

Die.....	0.8 x 0.8 x 2.6	.1.1
Base.....	1.0 x 1.0 x 0.6	.0.6
B. Base.....	1.4 x 1.4 x 0.8	.1.2
Weight complete 450 lbs.; no B. B. 240 lbs.		
C.....		\$35.00
D.....		31.50
F.....		30.00
G.....		29.25
H.....		28.25
I.....		27.50
K.....		26.50
L.....		25.25
If B. B. is omitted deduct \$4.20		

No. 3441 $\frac{1}{2}$

Die.....	0.6 x 0.6 x 2.4	.0.7
Base.....	0.10 x 0.10 x 0.6	.0.4
B. Base.....	1.2 x 1.2 x 0.8	.0.11
Weight complete 300 lbs.; no B. B. 150 lbs.		
C.....		\$23.00
D.....		21.00
F.....		20.00
G.....		19.50
H.....		19.00
I.....		18.50
K.....		18.00
L.....		17.25
If B. B. is omitted deduct \$3.45		

No. 3460.



Urn.....	0.8 x 0.8 x 1.4	.0.7
Die.....	1.2 x 1.2 x 3.4	.4.6
Base.....	1.6 x 1.6 x 0.8	.1.6
B. Base.....	2.0 x 2.0 x 1.2	.4.8
Weight complete 1900 lbs.; no B. B. 1200 lbs.		
C.....		\$130.00
D.....		115.00
F.....		109.00
G.....		105.00
H.....		102.00
I.....		99.00
K.....		94.00
L.....		89.00
If B. B. is omitted deduct \$16.35		

No. 3460 $\frac{1}{4}$

Urn.....	0.7 x 0.7 x 1.2	.0.5
Die.....	1.0 x 1.0 x 3.0	.3.0
Base.....	1.4 x 1.4 x 0.8	.1.2
B. Base.....	1.10 x 1.10 x 1.0	.3.4
Weight complete 1350 lbs.; no B. B. 750 lbs.		
C.....		\$92.50
D.....		82.50
F.....		77.00
G.....		75.50
H.....		73.00
I.....		71.00
K.....		67.50
L.....		64.00
If B. B. is omitted deduct \$11.65		

No. 3460 $\frac{1}{2}$

Urn.....	0.6 x 0.6 x 1.0	.0.3
Die.....	0.10 x 0.10 x 2.10	.2.0
Base.....	1.2 x 1.2 x 0.8	.0.11
B. Base.....	1.6 x 1.6 x 0.10	.1.11
Weight complete 850 lbs.; no B. B. 500 lbs.		
C.....		\$67.50
D.....		60.50
F.....		57.50
G.....		56.00
H.....		\$54.50
I.....		52.50
K.....		50.50
L.....		48.00
If B. B. is omitted deduct \$6.90		

No. 3460 $\frac{3}{4}$

See previous page.

No. 3462

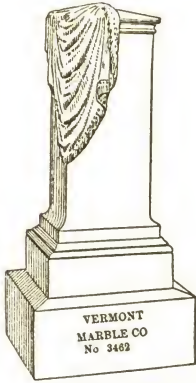

Die.....1. 6 x 1.2 x 3.2 . . 5. 7
 Base.....1. 10 x 1.6 x 0.8 . . 1.10
 B. Base....2. 4 x 2.0 x 1.0 . . 4. 8
 Weight complete 2200 lbs.; no B. B. 1330 lbs.

- C.....\$183.00
- D.....167.00
- F.....159.00
- G.....156.00
- H.....152.00
- I.....148.00
- K.....143.00
- L.....137.00

If B. B. is omitted deduct \$16.35

No. 3462¹/₄

Die.....1.4 x 1. 0 x 3.0 . . 4.0
 Base.....1.8 x 1. 4 x 0.8 . . 1.6
 B. Base....2. 2 x 1. 10 x 1.0 . . 4.0
 Weight complete 1600lbs.; no B. B. 880 lbs.

- C.....\$149.00
- D.....137.00
- F.....131.00
- G.....129.00
- H.....126.00
- I.....123.00
- K.....119.00
- L.....115.00

If B. B. is omitted deduct \$14.00

No. 3464



Die.....0.10 x 0.10 x 3. 2 . . 2. 2
 Base.....1. 2 x 1. 2 x 0. 8 . . 0.11
 B. Base....1. 6 x 1. 6 x 0.10 . . 1.11
 Weight complete 850 lbs.; no B. B. 500 lbs.

- C.....\$61.50
- D.....54.50
- F.....51.50
- G.....50.00
- H.....48.50
- I.....46.75
- K.....44.50
- L.....42.25

If B. B. is omitted deduct \$6.90

No. 3464¹/₄

Die.....0.8 x 0.8 x 2.10 . . 1.3
 Base.....1.0 x 1.0 x 0. 6 . . 0.6
 B. Base....1.4 x 1.4 x 0. 8 . . 1.2
 Weight complete 500 lbs.; no B. B. 300 lbs.

- C.....\$37.75
- D.....34.00
- F.....32.00
- G.....31.25
- H.....30.25
- I.....29.50
- K.....28.25
- L.....26.75

If B. B. is omitted deduct \$4.20

No. 3464¹/₂

Die.....0. 6 x 0. 6 x 2.4 . . 0. 7
 Base.....0.10 x 0.10 x 0.6 . . 0. 4
 B. Base....1. 2 x 1. 2 x 0.8 . . 0.11
 Weight complete 300 lbs.; no B. B. 150 lbs.

- C.....\$23.00
- D.....21.00
- F.....20.00
- G.....19.50
- H.....19.00
- I.....18.75
- K.....18.00
- L.....17.25

If B. B. is omitted deduct \$3.45

No. 3481



Die.....1. 0x1. 0x3.8. .3.8
 Base.....1. 4x1. 4x0.8. .1.2
 B. Base....1. 1.10x1.10x1.0. .3.4
 Weight complete 1350 lbs.; no B. B. 750 lbs.

D.....\$83.50
 H.....74.00
 I.....71.50
 K.....67.50
 L.....64.00
 If B. B. is omitted deduct \$11.65

No. 3481 $\frac{1}{4}$

Die.....0.10x0.10x3. 4. .2. 4
 Base.....1. 2x1. 2x0. 8. .0.11
 B. Base....1. 6x1. 6x0.10. .1.11
 Weight complete 850 lbs.; no B. B. 500 lbs.

D.....\$58.50
 H.....51.50
 I.....50.00
 K.....47.50
 L.....45.00
 If B. B. is omitted deduct \$6.90

No. 3481 $\frac{1}{2}$

Die.....0.8x0.8x2.10. .1.3
 Base.....1.0x1.0x0. 6. .0.6
 B. Base....1.4x1.4x0. 8. .1.2
 Weight complete 475 lbs.; no B. B. 275 lbs.

D.....\$34.00
 H.....30.50
 I.....29.50
 K.....28.25
 L.....26.75
 If B. B. is omitted deduct \$4.20

No. 3481 $\frac{3}{4}$

Die.....0. 6x0. 6x2.4. .0. 7
 Base.....0.10x0.10x0.6. .0. 4
 B. Base....1. 2x1. 2x0.8. .0.11
 Weight complete 300 lbs.; no B. B. 150 lbs.

D.....\$21.00
 H.....19.00
 I.....18.75
 K.....18.00
 L.....17.25
 If B. B. is omitted deduct \$3.45

No. 3482

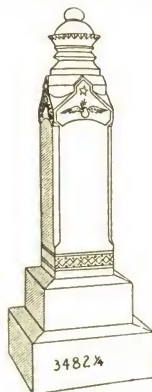

Die.....1. 0x1. 0x3.8. .3.8
 Base.....1. 4x1. 4x0.8. .1.2
 B. Base....1. 1.10x1.10x1.0. .3.4
 Weight complete 1350 lbs.; no B. B. 750 lbs.

C.....\$97.00
 D.....83.50
 F.....78.50
 G.....76.00
 H.....74.00
 I.....71.50
 K.....67.50
 L.....64.00

If B. B. is omitted deduct \$11.65

No. 3482 $\frac{1}{4}$

Die.....0.10x0.10x3. 4. .2. 4
 Base.....1. 2x1. 2x0. 8. .0.11
 B. Base....1. 6x1. 6x0.10. .1.11
 Weight complete 850 lbs.; no B. B. 500 lbs.

C.....\$65.50
 D.....58.00
 F.....55.00
 G.....53.50
 H.....51.50
 I.....50.00
 K.....47.50
 L.....45.00

If B. B. is omitted deduct \$6.90

No. 3482 $\frac{1}{2}$

Same sizes and prices as 3481 $\frac{1}{2}$.

No. 3482 $\frac{3}{4}$

Same sizes and prices as 3481 $\frac{3}{4}$.

No. 3484

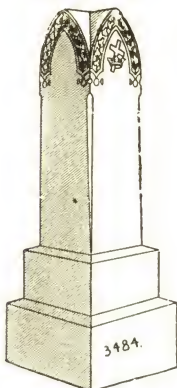

Die.....1. 0 x 1. 0 x 3.0..3.0
 Base.....1. 4 x 1. 4 x 0.8..1.2
 B. Base...1.10 x 1.10 x 1.0..3.4
 Weight complete 1300 lbs.; no B. B. 665 lbs.

- C.....\$79.00
- D.....69.50
- F.....65.50
- G.....63.50
- H.....61.50
- I.....59.00
- K.....56.00
- L.....53.00

If B. B. is omitted deduct \$11.65

No. 3484¹/₄

Die.....0.10 x 0.10 x 2.10..2.0
 Base.....1. 2 x 1. 2 x 0.8..0.11
 B. Base...1. 6 x 1. 6 x 0.10..1.11
 Weight complete 825 lbs.; no B. B. 480 lbs.

- C.....\$55.00
- D.....48.25
- F.....45.25
- G.....43.75
- H.....42.25
- I.....41.00
- K.....38.75
- L.....36.50

If B. B. is omitted deduct \$6.90

No. 3484¹/₂

Die.....0.8 x 0.8 x 2.6..1.1
 Base.....1.0 x 1.0 x 0.6..0.6
 B. Base...1.4 x 1.4 x 0.8..1.2
 Weight complete 450 lbs.; no B. B. 240 lbs.

- C.....\$33.25
- D.....29.75
- F.....28.25
- G.....27.50
- H.....26.50
- I.....25.75
- K.....24.75
- L.....23.50

If B. B. is omitted deduct \$4.20

No. 3492

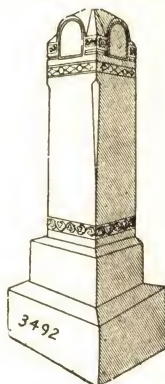

Die.....1. 0 x 1. 0 x 3.6..3.6
 Base.....1. 4 x 1. 4 x 0.8..1.2
 B. Base...1.10 x 1.10 x 1.0..3.4
 Weight complete 1400 lbs.; no B. B. 800 lbs.

- C.....\$89.00
- D.....79.00
- F.....74.00
- G.....72.00
- H.....69.50
- I.....67.00
- K.....63.50
- L.....60.00

If B. B. is omitted deduct \$11.65

No. 3492¹/₄

Die.....0.10 x 0.10 x 3.0..2.1
 Base.....1. 2 x 1. 2 x 0.8..0.11
 B. Base...1. 6 x 1. 6 x 0.10..1.11
 Weight complete 850 lbs.; no B. B. 500 lbs.

- C.....\$60.00
- D.....53.00
- F.....50.00
- G.....48.50
- H.....47.00
- I.....45.50
- K.....43.25
- L.....41.00

If B. B. is omitted deduct \$6.90

No. 3492¹/₂

Die.....0.8 x 0.8 x 2.6..1.1
 Base.....1.0 x 1.0 x 0.6..0.6
 B. Base...1.4 x 1.4 x 0.8..1.2
 Weight complete 450 lbs.; no B. B. 240 lbs.

- C.....\$34.50
- D.....31.00
- F.....29.50
- G.....28.75
- H.....27.75
- I.....27.00
- K.....26.00
- L.....24.75

If B. B. is omitted deduct \$4.20

No. 3493

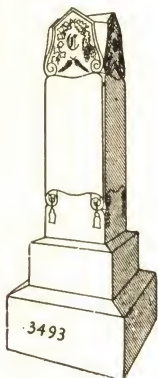

Die.....1. 0 x 1. 0 x 3.6..3.6
 Base.....1. 4 x 1. 4 x 0.8..1.2
 B. Base....1.10 x 1.10 x 1.0..3.4
 Weight complete 1400 lbs.; no B. B. 800 lbs.

C.....\$86.00
 D.....75.50
 F.....70.50
 G.....68.50
 H.....66.00
 I.....63.50
 K.....60.00
 L.....56.50

If B. B. is omitted deduct \$11.65

No. 3493¹/₄

Die.....0.10 x 0.10 x 3. 0..2. 1
 Base.....1. 2 x 1. 2 x 0. 8..0.11
 B. Base...1. 6 x 1. 6 x 0.10..1.11
 Weight complete 850 lbs.; no B. B. 500 lbs.

C.....\$58.00
 D.....51.00
 F.....48.00
 G.....46.50
 H.....45.00
 I.....43.50
 K.....41.25
 L.....39.00

If B. B. is omitted deduct \$6.90

No. 3493¹/₂

Die.....0.8 x 0.8 x 2.6..1.1
 Base.....1.0 x 1.0 x 0.6..0.6
 B. Base....1.4 x 1.4 x 0.8..1.2
 Weight complete 450 lbs.; no B. B. 240 lbs.

C.....\$33.25
 D.....29.75
 F.....28.25
 G.....27.50
 H.....26.50
 I.....25.75
 K.....24.75
 L.....23.50

If B. B. is omitted deduct \$4.20

No. 3496



Cross.....1.0 x 0.4 x 1. 4..0. 5
 Die.....1.2 x 1.2 x 3. 4..4. 6
 Base.....1.6 x 1.6 x 0.10..1.11
 B. Base....2.0 x 2.0 x 1. 0..4. 0
 Weight complete 1850 lbs.; no B. B.1130 lbs.

D..\$123.00 K...\$101.00
 H.. 110.00 L... 96.00
 I... 106.00

If B. B. is omitted deduct \$14.00

No. 3496¹/₄

Cross.....0.10 x 0. 4 x 1.2..0.4
 Die.....1. 0 x 1. 0 x 3.0..3.0
 Base.....1. 4 x 1. 4 x 0.8..1.2
 B. Base....1.10 x 1.10 x 1.0..3.4
 Weight complete 1300 lbs.; no B. B. 700 lbs.

D..\$89.00 K...\$74.00
 H... 80.00 L.... 71.00
 I... 77.50

If B. B. is omitted deduct \$11.65

No. 3496¹/₂

Cross....0.10 x 0. 3 x 1. 2..0. 3
 Die.....0.10 x 0.10 x 2.10..2. 0
 Base.....1. 2 x 1. 2 x 0. 8..0.11
 B. Base...1. 6 x 1. 6 x 0.10..1.11
 Weight complete 850 lbs.; no B. B. 500 lbs.

D..\$67.00 K...\$57.00
 H... 61.00 L.... 54.50
 I... 59.00

If B. B. is omitted deduct \$6.90

No. 3496³/₄

Cross.....0.8 x 0.2 x 1. 0..0.1
 Die.....0.8 x 0.8 x 2. 6..1.1
 Base.....1.0 x 1.0 x 0. 6..0.6
 B. Base....1.4 x 1.4 x 0.10..1.6
 Weight complete 500 lbs.; no B. B. 230 lbs.

D..\$46.00 K...\$40.50
 H... 42.50 L.... 39.25
 I... 41.50

If B. B. is omitted deduct \$5.40

No. 3502

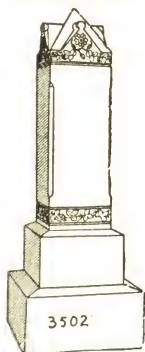

Die.....1. 0 x 1. 0 x 3.6..3.6
 Base.....1. 4 x 1. 4 x 0.8..1.2
 B. Base....1.10 x 1.10 x 1.0..3.4
 Weight complete 1400 lbs.; no B. B. 800 lbs.

- C.....\$88.50
- D.....78.00
- F.....73.00
- G.....71.00
- H.....68.50
- I.....66.00
- K.....62.50
- L.....59.00

If B. B. is omitted deduct \$11.65

No. 3503

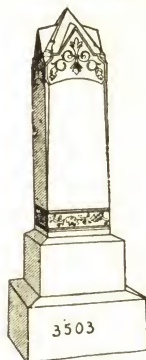

Die.....1. 0 x 1. 0 x 3.6..3.6
 Base.....1. 4 x 1. 4 x 0.8..1.2
 B. Base....1.10 x 1.10 x 1.0..3.4
 Weight complete 1400 lbs.; no B. B. 800 lbs.

- C.....\$88.50
- D.....77.75
- F.....73.00
- G.....71.00
- H.....68.50
- I.....66.00
- K.....62.50
- L.....59.00

If B. B. is omitted deduct \$11.65

No. 3502¹/₄

Die.....0.10 x 0.10 x 3. 2. .2. 2
 Base.....1. 2 x 1. 2 x 0. 8. .0.11
 B. Base...1. 6 x 1. 6 x 0.10. .1.11
 Weight complete 850 lbs.; no B. B. 500 lbs.

- C.....\$61.50
- D.....54.50
- F.....51.50
- G.....50.00
- H.....48.50
- I.....47.00
- K.....44.50
- L.....42.25

If B. B. is omitted deduct \$6.90

No. 3503¹/₄

Die.....0.10 x 0.10 x 3. 2. .2. 2
 Base.....1. 2 x 1. 2 x 0. 8. .0.11
 B. Base...1. 6 x 1. 6 x 0.10. .1.11
 Weight complete 850 lbs.; no B. B. 500 lbs.

- C.....\$61.50
- D.....54.50
- F.....51.50
- G.....50.00
- H.....48.25
- I.....46.75
- K.....44.50
- L.....42.25

If B. B. is omitted deduct \$6.90

No. 3502¹/₂

Die.....0.8 x 0.8 x 2.8..1.2
 Base.....1.0 x 1.0 x 0.6..0.6
 B. Base....1.4 x 1.4 x 0.8..1.2
 Weight complete 475 lbs.; no B. B. 265 lbs.

- C.....\$37.50
- D.....33.75
- F.....32.25
- G.....31.25
- H.....30.50
- I.....29.75
- K.....28.50
- L.....27.25

If B. B. is omitted deduct \$4.20

No. 3503¹/₂

Die.....0.8 x 0.8 x 2.8..1.2
 Base.....1.0 x 1.0 x 0.6..0.6
 B. Base....1.4 x 1.4 x 0.8..1.2
 Weight complete 475 lbs.; no B. B. 265 lbs.

- C.....\$37.50
- D.....33.75
- F.....32.25
- G.....31.25
- H.....30.50
- I.....29.75
- K.....28.50
- L.....27.25

If B. B. is omitted deduct \$4.20

No. 3504

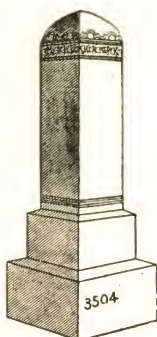

Die.....1. 0 x 1. 0 x 3.4. .3.4
 Base.....1. 4 x 1. 4 x 0.8. .1.2
 B. Base....1. 10 x 1. 10 x 1.0. .3.4
 Weight complete 1400 lbs.; no B. B. 800 lbs.

C.....\$82.50
 D.....72.00
 F.....67.50
 G.....65.00
 H.....63.00
 I.....60.50
 K.....57.00
 L.....54.00

If B. B. is omitted deduct \$11.65

No. 3508

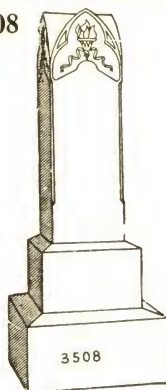

Die.....1. 0 x 1. 0 x 3.0. .3.0
 Base.....1. 4 x 1. 4 x 0.8. .1.2
 B. Base....1. 10 x 1. 10 x 1.0. .3.4
 Weight complete 1300 lbs.; no B. B. 700 lbs.

C.....\$78.50
 D.....69.00
 F.....65.00
 G.....63.00
 H.....60.75
 I.....58.75
 K.....55.50
 L.....52.50

If B. B. is omitted deduct \$11.65

No. 3504¹/₄

Die.....0.10 x 0.10 x 3. 0. .2. 1
 Base.....1. 2 x 1. 2 x 0. 8. .0.11
 B. Base....1. 6 x 1. 6 x 0.10. .1.11
 Weight complete 850 lbs.; no B. B. 500 lbs.

C.....\$56.50
 D.....49.75
 F.....46.75
 G.....45.25
 H.....43.75
 I.....42.25
 K.....40.00
 L.....37.75

If B. B. is omitted deduct \$6.90

No. 3508¹/₄

Die.....0.10 x 0.10 x 2. 10. .2. 0
 Base.....1. 2 x 1. 2 x 0. 8. .0.11
 B. Base....1. 6 x 1. 6 x 0.10. .1.11
 Weight complete 825 lbs.; no B. B. 480 lbs.

C.....\$54.75
 D.....48.25
 F.....45.25
 G.....43.75
 H.....42.25
 I.....41.00
 K.....38.75
 L.....36.50

If B. B. is omitted deduct \$6.90

No. 3504¹/₂

Die.....0.8 x 0.8 x 2.6. .1.1
 Base.....1.0 x 1.0 x 0.6. .0.6
 B. Base....1.4 x 1.4 x 0.8. .1.2
 Weight complete 475 lbs.; no B. B. 265 lbs.

C.....\$32.50
 D.....29.00
 F.....27.50
 G.....26.75
 H.....25.75
 I.....25.00
 K.....24.00
 L.....22.75

If B. B. is omitted deduct \$4.20

No. 3508¹/₂

Die.....0.8 x 0.8 x 2.6. .1.1
 Base.....1.0 x 1.0 x 0.6. .0.6
 B. Base....1.4 x 1.4 x 0.8. .1.2
 Weight complete 450 lbs.; no B. B. 240 lbs.

C.....\$33.25
 D.....29.75
 F.....28.25
 G.....27.50
 H.....26.50
 I.....25.75
 K.....24.75
 L.....23.50

If B. B. is omitted deduct \$4.20

No. 3509

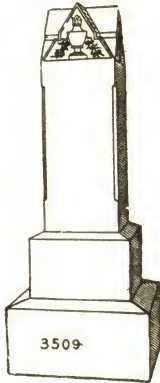

Die.....1. 0 x 1. 0 x 3.0 . 3.0
 Base.....1. 4 x 1. 4 x 0.8 . 1.2
 B. Base....1. 10 x 1.10 x 1.0 . 3.4
 Weight complete 1300 lbs.; no B. B. 700 lbs.

- C.....\$78.50
- D.....69.00
- F.....65.00
- G.....63.00
- H.....61.00
- I.....58.50
- K.....55.50
- L.....52.50

If B. B. is omitted deduct \$11.65

No. 3510

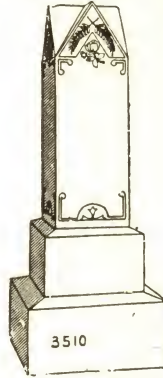

Die.....1. 0 x 1. 0 x 3.0 . 3.0
 Base.....1. 4 x 1. 4 x 0.8 . 1.2
 B. Base....1. 10 x 1.10 x 1.0 . 3.4
 Weight complete 1300 lbs.; no B. B. 700 lbs.

- C.....\$78.50
- D.....69.00
- F.....65.00
- G.....63.00
- H.....61.00
- I.....58.50
- K.....55.50
- L.....52.50

If B. B. is omitted deduct \$11.65

No. 3509¹/₄

Die.....0.10 x 0.10 x 2.10 . 2. 0
 Base.....1. 2 x 1. 2 x 0. 8 . 0.11
 B. Base...1. 6 x 1. 6 x 0.10 . 1.11
 Weight complete 825 lbs.; no B. B. 480 lbs.

- C.....\$55.00
- D.....48.25
- F.....45.25
- G.....43.75
- H.....42.25
- I.....41.00
- K.....38.75
- L.....36.50

If B. B. is omitted deduct \$6.90

No. 3510¹/₄

Die.....0.10 x 0.10 x 2.10 . 2. 0
 Base.....1. 2 x 1. 2 x 0. 8 . 0.11
 B. Base...1. 6 x 1. 6 x 0.10 . 1.11
 Weight complete 825 lbs.; no B. B. 480 lbs.

- C.....\$55.00
- D.....48.25
- F.....45.25
- G.....43.75
- H.....42.25
- I.....41.00
- K.....38.75
- L.....36.50

If B. B. is omitted deduct \$6.90

No. 3509¹/₂

Die.....0.8 x 0.8 x 2.6 . 1.1
 Base.....1.0 x 1.0 x 0.6 . 0.6
 B. Base....1.4 x 1.4 x 0.8 . 1.2
 Weight complete 450 lbs.; no B. B. 240 lbs.

- C.....\$33.25
- D.....29.75
- F.....28.25
- G.....27.50
- H.....26.50
- I.....25.75
- K.....24.75
- L.....23.50

If B. B. is omitted deduct \$4.20

No. 3510¹/₂

Die.....0.8 x 0.8 x 2.6 . 1.1
 Base.....1.0 x 1.0 x 0.6 . 0.6
 B. Base....1.4 x 1.4 x 0.8 . 1.2
 Weight complete 450 lbs.; no B. B. 240 lbs.

- C.....\$33.25
- D.....29.75
- F.....28.25
- G.....27.50
- H.....26.50
- I.....25.75
- K.....24.75
- L.....23.50

If B. B. is omitted deduct \$4.20

No. 3528

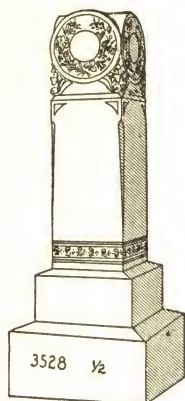

Die.....1. 0 x 1. 0 x 3.6..3.6
 Base.....1. 4 x 1. 4 x 0.8..1.2
 B. Base....1.10 x 1.10 x 1.0..3.4
 Weight complete 1400 lbs.; no B. B. 800 lbs.

C.....\$88.00
 D.....77.50
 F.....72.50
 G.....70.50
 H.....68.00
 I.....65.50
 K.....62.00
 L.....58.50

If B. B. is omitted deduct \$11.65

No. 3528¹/₄

Die.....0.10 x 0.10 x 3. 2..2. 2
 Base.....1. 2 x 1. 2 x 0. 8..0.11
 B. Base...1. 6 x 1. 6 x 0.10..1.11
 Weight complete 900 lbs.; no B. B. 550 lbs.

C.....\$60.00
 D.....53.00
 F.....50.00
 G.....48.50
 H.....46.75
 I.....45.25
 K.....43.00
 L.....40.75

If B. B. is omitted deduct \$6.90

No. 3528¹/₂

Die.....0.8 x 0.8 x 2.8..1.2
 Base.....1.0 x 1.0 x 0.6..0.6
 B. Base....1.4 x 1.4 x 0.8..1.2
 Weight complete 500 lbs.; no B. B. 290 lbs.

C.....\$33.75
 D.....30.00
 F.....28.50
 G.....27.50
 H.....26.75
 I.....26.00
 K.....24.75
 L.....23.50

If B. B. is omitted deduct \$4.20

No. 3535

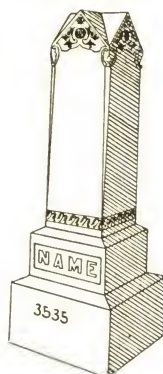

Die.....1. 0 x 1. 0 x 3.4..3.4
 Base.....1. 4 x 1. 4 x 0.8..1.2
 B. Base....1.10 x 1.10 x 1.0..3.4
 Weight complete 1400 lbs.; no B. B. 800 lbs.

D.....\$73.00
 H.....64.00
 I.....61.50
 K.....58.00
 L.....55.00
 If B. B. is omitted deduct \$11.65

No. 3535¹/₄

Die.....0.10 x 0.10 x 3.0..2. 1
 Base.....1. 2 x 1. 2 x 0.8..0.11
 B. Base....1. 6 x 1. 6 x 1.0..2. 3
 Weight complete 925 lbs.; no B. B. 520 lbs.

D.....\$53.00
 H.....47.00
 I.....45.50
 K.....43.25
 L.....41.00
 If B. B. is omitted deduct \$8.10

No. 3535¹/₂

Die.....0.8 x 0.8 x 2. 6..1.1
 Base.....1.0 x 1.0 x 0. 6..0.6
 B. Base....1.4 x 1.4 x 0.10..1.6
 Weight complete 550 lbs.; no B. B. 280 lbs.

D.....\$30.00
 H.....26.75
 I.....26.00
 K.....25.00
 L.....23.75
 If B. B. is omitted deduct \$5.40

No. 3535³/₄

Die.....0. 6 x 0. 6 x 2.0..0. 6
 Base.....0.10 x 0.10 x 0.6..0. 4
 B. Base....1. 2 x 1. 2 x 0.8..0. 11
 Weight complete 325 lbs.; no B. B. 160 lbs.

D.....\$18.00
 H.....16.25
 I.....15.75
 K.....15.25
 L.....14.50
 If B. B. is omitted deduct \$3.45

No. 3537

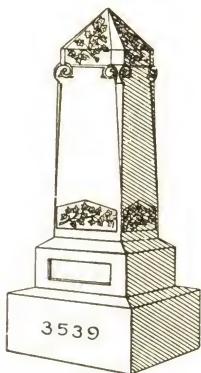

Die.....1. 0x1. 0x3.4. 3.4
 Base.....1. 4x1. 4x0.8. 1.2
 B. Base....1.10x1.10x1.0. 3.4
 Weight complete 1375 lbs.; no B. B. 775 lbs.
 D.....\$72.00
 H.....63.00
 I.....60.50
 K.....57.00
 L.....54.00
 If B. B. is omitted deduct \$11.65

No. 3537¹/₄

Die.....0.10x0.10x3.0. 2. 1
 Base.....1. 2x1. 2x0.8. 0.11
 B. Base....1. 6x1. 6x1.0. 2. 3
 Weight complete 925 lbs.; no B. B. 520 lbs.
 D.....\$52.00
 H.....46.00
 I.....44.50
 K.....42.25
 L.....40.00
 If B. B. is omitted deduct \$8.10

No. 3537¹/₂

Die.....0.8x0.8x2. 6. 1. 1
 Base.....1.0x1.0x0. 6. 0. 6
 B. Base....1.4x1.4x0.10. 1.6
 Weight complete 550 lbs.; no B. B. 280 lbs.
 D.....\$29.00
 H.....25.75
 I.....25.00
 K.....24.00
 L.....22.75
 If B. B. is omitted deduct \$5.40

No. 3537³/₄

Die.....0. 6x0. 6x2.0. 0. 6
 Base.....0.10x0.10x0.6. 0. 4
 B. Base....1. 2x1. 2x0.8. 0.11
 Weight complete 325 lbs.; no B. B. 160 lbs.
 D.....\$17.50
 H.....15.75
 I.....15.25
 K.....14.75
 L.....14.00
 If B. B. is omitted deduct \$3.45

No. 3539¹/₄

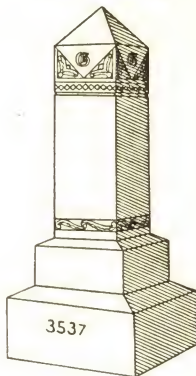

Die.....1. 0x1. 0x3.6. 3.6
 Base.....1. 4x1. 4x0.8. 1.2
 B. Base....1.10x1.10x1.0. 3.4
 Weight complete 1400 lbs.; no B. B. 800 lbs.
 C.....\$88.00
 D.....77.50
 F.....72.50
 G.....70.50
 H.....68.00
 I.....65.50
 K.....62.00
 L.....58.50
 If B. B. is omitted deduct \$11.65

No. 3539¹/₂

Die.....0.10x0.10x3.2. 2. 2
 Base.....1. 2x1. 2x0.8. 0.11
 B. Base....1. 6x1. 6x1.0. 2. 3
 Weight complete 950 lbs.; no B. B. 500 lbs.
 C.....\$61.00
 D.....54.00
 F.....51.00
 G.....49.50
 H.....48.00
 I.....46.25
 K.....44.00
 L.....41.75
 If B. B. is omitted deduct \$8.10

No. 3539³/₄

Die.....0.8x0.8x2. 8. 1. 2
 Base.....1.0x1.0x0. 6. 0. 6
 B. Base....1.4x1.4x0.10. 1.6
 Weight complete 550 lbs.; no B. B. 280 lbs.
 C.....\$36.75
 D.....33.00
 F.....31.50
 G.....30.50
 H.....29.75
 I.....29.00
 K.....27.75
 L.....26.50
 If B. B. is omitted deduct \$5.40

No. 3544

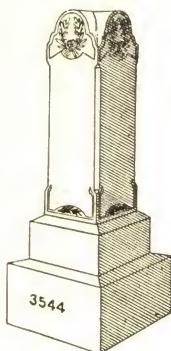

Die.....1. 0 x 1. 0 x 3.4 . 3.4
 Base.....1. 4 x 1. 4 x 0.8 . 1.2
 B. Base....1.10 x 1.10 x 1.0 . 3.4
 Weight complete 1375 lbs.; no B. B. 775 lbs.

C.....\$85.00
 D.....75.00
 F.....70.50
 G.....68.00
 H.....66.00
 I.....63.50
 K.....60.00
 L.....57.00

If B. B. is omitted deduct \$11.65

No. 3544¹/₄

Die.....0.10 x 0.10 x 3.0 . 2. 1
 Base.....1. 2 x 1. 2 x 0.8 . 0.11
 B. Base....1. 6 x 1. 6 x 1.0 . 2. 3
 Weight complete 925 lbs.; no B. B. 520 lbs.

C.....\$61.00
 D.....54.00
 F.....51.00
 G.....49.50
 H.....48.00
 I.....46.50
 K.....44.25
 L.....42.00

If B. B. is omitted deduct \$8.10

No. 3544¹/₂

Die.....0.8 x 0.8 x 2. 6 . 1.1
 Base.....1.0 x 1.0 x 0. 6 . 0.6
 B. Base....1.4 x 1.4 x 0.10 . 1.6
 Weight complete 550 lbs.; no B. B. 280 lbs.

C.....\$35.25
 D.....31.75
 F.....30.25
 G.....29.50
 H.....28.50
 I.....27.75
 K.....26.25
 L.....25.50

If B. B. is omitted deduct \$5.40

No. 3545

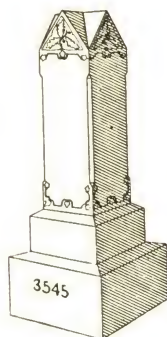

Die.....1. 0 x 1. 0 x 3.4 . 3.4
 Base.....1. 4 x 1. 4 x 0.8 . 1.2
 B. Base....1.10 x 1.10 x 1.0 . 3.4
 Weight complete 1375 lbs.; no B. B. 775 lbs.

C.....\$83.00
 D.....73.00
 F.....68.50
 G.....66.00
 H.....64.00
 I.....61.50
 K.....58.00
 L.....55.00

If B. B. is omitted deduct \$11.65

No. 3545¹/₄

Die.....0.10 x 0.10 x 3.0 . 2. 1
 Base.....1. 2 x 1. 2 x 0.8 . 0.11
 B. Base....1. 6 x 1. 6 x 1.0 . 2. 3
 Weight complete 925 lbs.; no B. B. 520 lbs.

C.....\$60.00
 D.....53.00
 F.....50.00
 G.....48.50
 H.....47.00
 I.....45.50
 K.....43.25
 L.....41.00

If B. B. is omitted deduct \$8.10

No. 3545¹/₂

Die.....0.8 x 0.8 x 2. 6 . 1.1
 Base.....1.0 x 1.0 x 0. 6 . 0.6
 B. Base....1.4 x 1.4 x 0.10 . 1.6
 Weight complete 550 lbs.; no B. B. 265 lbs.

C.....\$34.25
 D.....30.75
 F.....29.25
 G.....28.50
 H.....27.50
 I.....26.75
 K.....25.75
 L.....24.50

If B. B. is omitted deduct \$5.40

No. 3545³/₄

See next page.

No. 3550

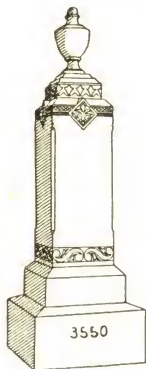

Urn.....0. 8 x 0. 8 x 1.4 .0.7
 Plinth.....0.10 x 0.10 x 0.6 .0.4
 Die.....1. 2 x 1. 2 x 3.0 .4.1
 Base.....1. 6 x 1. 6 x 0.8 .1.6
 B. Base....2. 0 x 2. 0 x 1.2 .4.8
 Weight complete 1950 lbs.; no B. B. 1110 lbs.

C.....	\$130.00
D.....	115.00
F.....	109.00
G.....	106.00
H.....	102.00
I.....	99.00
K.....	94.00
L.....	89.00

If B. B. is omitted deduct \$16.35

No. 3550¹/₄

Urn.....0. 7 x 0. 7 x 1.2 .0.5
 Plinth.....0. 8 x 0. 8 x 0.5 .0.2
 Die.....1. 0 x 1. 0 x 2.8 .2.8
 Base.....1. 4 x 1. 4 x 0.8 .1.2
 B. Base....1. 10 x 1.10 x 1.0 .3.4
 Weight complete 1350 lbs.; no B. B. 750 lbs.

C.....	\$88.50
D.....	78.50
F.....	74.50
G.....	72.00
H.....	70.00
I.....	67.50
K.....	64.50
L.....	61.00

If B. B. is omitted deduct \$11.65

No. 3545³/₄

Die.....0. 6 x 0. 6 x 2.0 .0. 6
 Base.....0.10 x 0.10 x 0.6 .0. 4
 B. Base....1. 2 x 1. 2 x 0.8 .0.11
 Weight complete 325 lbs.; no B. B. 160 lbs.

C.....	\$19.25
D.....	17.50
F.....	16.50
G.....	16.25
H.....	15.75
I.....	15.25
K.....	14.75
L.....	14.00

If B. B. is omitted deduct \$3.45

No. 3553

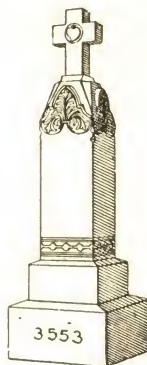

Cross.....1. 0 x 0. 4 x 1.4 .0.5
 Die.....1. 0 x 1. 0 x 3.2 .3.2
 Base.....1. 4 x 1. 4 x 0.8 .1.2
 B. Base....1. 10 x 1.10 x 1.0 .3.4
 Weight complete 1400 lbs.; no B. B. 800 lbs.

C.....	\$97.50
D.....	86.50
F.....	81.50
G.....	79.50
H.....	77.00
I.....	74.50
K.....	71.00
L.....	67.50

If B. B. is omitted deduct \$11.65

No. 3553¹/₄

Cross....0.10 x 0. 3 x 1. 2 .0. 3
 Die.....0.10 x 0.10 x 2.10 .2. 0
 Base.....1. 2 x 1. 2 x 0. 8 .0.11
 B. Base....1. 6 x 1. 6 x 1. 0 .2. 3
 Weight complete 950 lbs.; no B. B. 545 lbs.

C.....	\$68.50
D.....	61.50
F.....	58.50
G.....	57.00
H.....	55.50
I.....	53.50
K.....	51.50
L.....	49.00

If B. B. is omitted deduct \$8.10

No. 3553¹/₂

Cross.....0.8 x 0.3 x 1. 0 .0.2
 Die.....0.8 x 0.8 x 2. 6 .1.1
 Base.....1.0 x 1.0 x 0. 6 .0.6
 B. Base....1.4 x 1.4 x 0.10 .1.6
 Weight complete 575 lbs.; no B. B. 305 lbs.

C.....	\$46.00
D.....	42.25
F.....	40.25
G.....	39.50
H.....	38.50
I.....	37.75
K.....	36.50
L.....	35.00

If B. B. is omitted deduct \$5.40

No. 3554

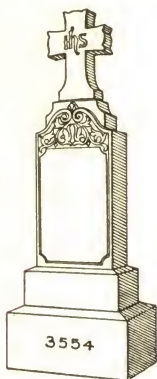

Cross.....1. 2 x 0. 5 x 1.8. .0.10
 Die.....1. 6 x 0.10 x 3.0. .3. 9
 Base.....1.10 x 1. 2 x 0.8. .1. 5
 B. Base...2. 4 x 1. 8 x 1.2. .4. 6

Weight complete 1825 lbs.; no B. B. 1015 lbs.

C.....	\$129.00
D.....	115.00
F.....	109.00
G.....	106.00
H.....	103.00
I.....	100.00
K.....	95.50
L.....	91.00

If B. B. is omitted deduct \$15.75

No. 3554¹/₄

Cross.....1.1 x 0.4 x 1. 6. .0.7
 Die.....1.4 x 0.8 x 2.10. .2.6
 Base.....1.8 x 1.0 x 0. 8. .1.1
 B. Base...2.0 x 1.4 x 0.10. .2.3

Weight complete 1100 lbs.; no B. B. 695 lbs.

C.....	\$90.50
D.....	81.00
F.....	77.00
G.....	75.00
H.....	73.00
I.....	70.50
K.....	67.50
L.....	64.50

If B. B. is omitted deduct \$8.10

No. 3558¹/₄

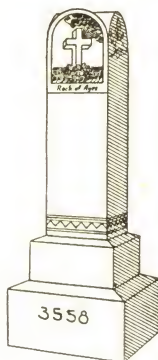

Die.....1. 0 x 1. 0 x 3.6. .3.6
 Base.....1. 4 x 1. 4 x 0.8. .1.2
 B. Base...1.10 x 1.10 x 1.0. .3.4

Weight complete 1400 lbs.; no B. B. 800 lbs.

C.....	\$84.50
D.....	74.00
F.....	69.00
G.....	67.00
H.....	64.50
I.....	62.00
K.....	58.50
L.....	54.00

If B. B. is omitted deduct \$11.65

No. 3558¹/₂

Die.....0.10 x 0.10 x 3.2. .2. 2
 Base.....1. 2 x 1. 2 x 0.8. .0.11
 B. Base...1. 6 x 1. 6 x 1.0. .2. 3

Weight complete 950 lbs.; no B. B. 545 lbs.

C.....	\$59.00
D.....	52.00
F.....	49.00
G.....	47.50
H.....	45.75
I.....	44.25
K.....	42.00
L.....	39.75

If B. B. is omitted deduct \$8.10

No. 3558³/₄

Die.....0.8 x 0.8 x 2. 8. .1. 2
 Base.....1.0 x 1.0 x 0. 6. .0. 6
 B. Base...1.4 x 1.4 x 0.10. .1. 6

Weight complete 550 lbs.; no B. B. 280 lbs.

C.....	\$34.00
D.....	30.25
F.....	28.75
G.....	27.75
H.....	27.00
I.....	26.25
K.....	25.00
L.....	23.75

If B. B. is omitted deduct \$5.40

No. 3563

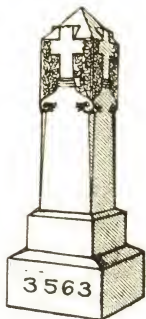

Die.....1.2 x 1.2 x 3.8..5.0
 Base.....1.6 x 1.6 x 0.8..1.6
 B. Base.....2.0 x 2.0 x 1.2..4.8
 Weight complete 1950 lbs.; no B. B. 1110 lbs.
 D.....\$108.00
 H.....95.50
 I.....92.00
 K.....87.00
 L.....82.50
 If B. B. is omitted deduct \$16.35

No. 3563¹/₄

Die.....1.0 x 1.0 x 3.6..3.6
 Base.....1.4 x 1.4 x 0.8..1.2
 B. Base.....1.10 x 1.10 x 1.0..3.4
 Weight complete 1400 lbs.; no B. B. 800 lbs.
 D.....\$78.00
 H.....68.50
 I.....66.00
 K.....62.50
 L.....59.00
 If B. B. is omitted deduct \$11.65

No. 3563¹/₂

Die.....0.10 x 0.10 x 3.2..2.2
 Base.....1.2 x 1.2 x 0.8..0.11
 B. Base.....1.6 x 1.6 x 1.0..2.3
 Weight complete 950 lbs.; no B. B. 545 lbs.
 D.....\$58.00
 H.....52.00
 I.....50.50
 K.....48.00
 L.....45.75
 If B. B. is omitted deduct \$8.10

No. 3563³/₄

Die.....0.8 x 0.8 x 2.8..1.2
 Base.....1.0 x 1.0 x 0.6..0.6
 B. Base.....1.4 x 1.4 x 0.8..1.2
 Weight complete 500 lbs.; no B. B. 290 lbs.
 D.....\$33.75
 H.....30.50
 I.....29.75
 K.....28.50
 L.....27.25
 If B. B. is omitted deduct \$4.20

No. 3564

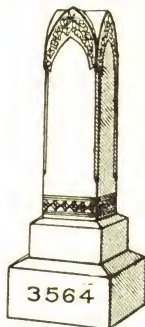

Die.....1.2 x 1.2 x 3.8..5.0
 Base.....1.6 x 1.6 x 0.8..1.6
 B. Base.....2.0 x 2.0 x 1.2..4.8
 Weight complete 1950 lbs.; no B. B. 1110 lbs.
 D.....\$103.00
 H.....90.00
 I.....86.50
 K.....81.50
 L.....77.00
 If B. B. is omitted deduct \$16.35

No. 3564¹/₄

Die.....1.0 x 1.0 x 3.4..3.4
 Base.....1.4 x 1.4 x 0.8..1.2
 B. Base.....1.10 x 1.10 x 1.0..3.4
 Weight complete 1375 lbs.; no B. B. 775 lbs.
 D.....\$73.00
 H.....64.00
 I.....61.50
 K.....58.00
 L.....55.00
 If B. B. is omitted deduct \$11.65

No. 3564¹/₂

Die.....0.10 x 0.10 x 3.0..2.1
 Base.....1.2 x 1.2 x 0.8..0.11
 B. Base.....1.6 x 1.6 x 1.0..2.3
 Weight complete 900 lbs.; no B. B. 495 lbs.
 D.....\$52.00
 H.....45.50
 I.....44.00
 K.....41.75
 L.....39.50
 If B. B. is omitted deduct \$8.10

No. 3564³/₄

Die.....0.8 x 0.8 x 2.6..1.1
 Base.....1.0 x 1.0 x 0.6..0.6
 B. Base.....1.4 x 1.4 x 0.10..1.6
 Weight complete 550 lbs.; no B. B. 280 lbs.
 D.....\$30.00
 H.....26.75
 I.....26.00
 K.....25.00
 L.....23.75
 If B. B. is omitted deduct \$5.40

No. 3565

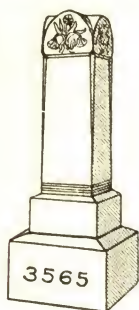

Die.....	1.2 x 1.2 x 3.8..	5.0
Base.....	1.6 x 1.6 x 0.8..	1.6
B. Base.....	2.0 x 2.0 x 1.2..	4.8
Weight complete 1950 lbs.; no B. B. 1110 lbs.		
D.....		\$102.00
H.....		89.00
I.....		85.50
K.....		80.50
L.....		76.00
If B. B. is omitted deduct \$16.35		

No. 3565 $\frac{1}{4}$

Die.....	1.0 x 1.0 x 3.4..	3.4
Base.....	1.4 x 1.4 x 0.8..	1.2
B. Base.....	1.10 x 1.10 x 1.0..	3.4
Weight complete 1375 lbs.; no B. B. 775 lbs.		
D.....		\$72.00
H.....		63.00
I.....		60.50
K.....		57.00
L.....		54.00
If B. B. is omitted deduct \$11.65		

No. 3565 $\frac{1}{2}$

Die.....	0.10 x 0.10 x 3.0..	.2.1
Base.....	1.2 x 1.2 x 0.8..	0.11
B. Base.....	1.6 x 1.6 x 1.0..	.2.3
Weight complete 900 lbs.; no B. B. 500 lbs.		
D.....		\$51.00
H.....		44.50
I.....		43.00
K.....		41.75
L.....		39.50
If B. B. is omitted deduct \$8.10		

No. 3565 $\frac{3}{4}$

Die.....	0.8 x 0.8 x 2.6..	1.1
Base.....	1.0 x 1.0 x 0.6..	0.6
B. Base.....	1.4 x 1.4 x 0.10..	1.6
Weight complete 550 lbs.; no B. B. 280 lbs.		
D.....		\$29.50
H.....		26.25
I.....		25.50
K.....		24.50
L.....		23.25
If B. B. is omitted deduct \$5.40		

No. 3568 $\frac{1}{4}$ 

Finial.....	0.8 x 0.8 x 1.2..	0.6
Die.....	1.0 x 1.0 x 3.2..	3.2
Base.....	1.4 x 1.4 x 0.8..	1.2
B. Base.....	1.10 x 1.10 x 1.0..	3.4
Weight complete 1400 lbs.; no B. B. 800 lbs.		
C.....		\$94.50
D.....		89.50
F.....		78.50
G.....		76.00
H.....		74.00
I.....		71.50
K.....		67.50
L.....		64.00
If B. B. is omitted deduct \$11.65		

No. 3568 $\frac{1}{2}$

Finial.....	0.7 x 0.7 x 1.0..	0.4
Die.....	0.10 x 0.10 x 2.10..	.2.0
Base.....	1.2 x 1.2 x 0.8..	0.11
B. Base.....	1.6 x 1.6 x 1.0..	.2.3
Weight complete 975 lbs.; no B. B. 570 lbs.		
C.....		\$67.50
D.....		60.00
F.....		57.00
G.....		55.50
H.....		53.50
I.....		52.00
K.....		49.50
L.....		47.25
If B. B. is omitted deduct \$8.10		

No. 3569 $\frac{3}{4}$

Cross.....	0.8 x 0.3 x 1.0..	0.2
Die.....	0.8 x 0.8 x 2.6..	1.1
Base.....	1.0 x 1.0 x 0.6..	0.6
B. Base.....	1.4 x 1.4 x 0.10..	1.6
Weight complete 575 lbs.; no B. B. 300 lbs.		
C.....		\$50.50
D.....		46.75
F.....		44.75
G.....		44.00
H.....		43.00
I.....		42.25
K.....		41.00
L.....		39.50
If B. B. is omitted deduct \$5.40		

No. 3569



Cross.....1.0 x 0.4 x 1.4..0.5
 Die.....1.2 x 1.2 x 3.4..4.6
 Base.....1.6 x 1.6 x 0.8..1.6
 B. Base.....2.0 x 2.0 x 1.2..4.8
 Weight complete 1950 lbs.; no B. B. 1110 lbs.

- C.....\$140.00
 - D.....125.00
 - F.....119.00
 - G.....116.00
 - H.....112.00
 - I.....108.00
 - K.....103.00
 - L.....98.00
- If B. B. is omitted deduct \$16.35

No. 3569¹/₄

Cross.....0.10 x 0.4 x 1.2..0.4
 Die.....1.0 x 1.0 x 3.2..3.2
 Base.....1.4 x 1.4 x 0.8..1.2
 B. Base.....1.10 x 1.10 x 1.0..3.4
 Weight complete 1400 lbs.; no B. B. 800 lbs.

- C.....\$99.50
 - D.....89.00
 - F.....84.00
 - G.....82.00
 - H.....80.00
 - I.....77.50
 - K.....74.00
 - L.....71.00
- If B. B. is omitted deduct \$11.65

No. 3569¹/₂

Cross.....0.10 x 0.3 x 1.2..0.3
 Die.....0.10 x 0.10 x 2.10..2.0
 Base.....1.2 x 1.2 x 0.8..0.11
 B. Base...1.6 x 1.6 x 1.0..2.3
 Weight complete 950 lbs.; no B. B. 545 lbs.

- C.....\$75.00
 - D.....68.00
 - F.....65.00
 - G.....63.50
 - H.....62.00
 - I.....60.00
 - K.....58.00
 - L.....55.50
- If B. B. is omitted deduct \$8.10

No. 3569³/₄

See previous page.

No. 3571

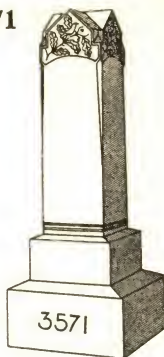

Die.....1.0 x 1.0 x 3.4..3.4
 Base.....1.4 x 1.4 x 0.8..1.2
 B. Base.....1.10 x 1.10 x 1.0..3.4
 Weight complete 1375 lbs.; no B. B. 775 lbs.

- C.....\$84.00
 - D.....74.00
 - F.....69.50
 - G.....67.00
 - H.....65.00
 - I.....62.50
 - K.....58.00
 - L.....56.00
- If B. B. is omitted deduct \$11.65

No. 3571¹/₄

Die.....0.10 x 0.10 x 3.0..2.1
 Base.....1.2 x 1.2 x 0.8..0.11
 B. Base...1.6 x 1.6 x 1.0..2.3
 Weight complete 900 lbs.; no B. B. 500 lbs.

- C.....\$60.50
 - D.....53.50
 - F.....50.50
 - G.....49.00
 - H.....47.50
 - I.....46.00
 - K.....43.75
 - L.....41.50
- If B. B. is omitted deduct \$8.10

No. 3571¹/₂

Die.....0.8 x 0.8 x 2.6..1.1
 Base.....1.0 x 1.0 x 0.6..0.6
 B. Base.....1.4 x 1.4 x 0.10..1.6
 Weight complete 550 lbs.; no B. B. 280 lbs.

- C.....\$36.00
 - D.....32.50
 - F.....31.00
 - G.....30.25
 - H.....29.25
 - I.....28.50
 - K.....27.50
 - L.....26.25
- If B. B. is omitted deduct \$5.40

No. 3572

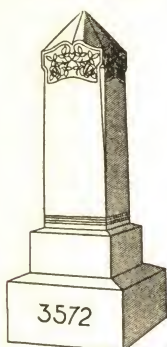

Die.....1. 0 x 1. 0 x 3.6. .3.6
 Base.....1. 4 x 1. 4 x 0.8. .1.2
 B. Base....1.10 x 1.10 x 1.0. .3.4
 Weight complete 1400 lbs.; no B. B. 800 lbs.

C.....\$88.50
 D.....78.00
 F.....73.00
 G.....71.00
 H.....68.50
 I.....66.00
 K.....62.50
 L.....59.00

If B. B. is omitted deduct \$11.65

No. 3572¹/₄

Die.....0.10 x 0.10 x 3.2. .2. 2
 Base.....1. 2 x 1. 2 x 0.8. .0.11
 B. Base....1. 6 x 1. 6 x 1.0. .2. 3
 Weight complete 900 lbs.; no B. B. 500 lbs.

C.....\$61.50
 D.....54.50
 F.....51.50
 G.....50.00
 H.....48.25
 I.....46.75
 K.....44.50
 L.....42.25

If B. B. is omitted deduct \$8.10

No. 3572¹/₂

Die.....0.8 x 0.8 x 2. 8. .1. 2
 Base.....1.0 x 1.0 x 0. 6. .0. 6
 B. Base....1.4 x 1.4 x 0.10. .1. 6
 Weight complete 550 lbs.; no B. B. 280 lbs.

C.....\$38.75
 D.....35.00
 F.....33.50
 G.....32.50
 H.....31.75
 I.....31.00
 K.....29.75
 L.....28.50

If B. B. is omitted deduct \$5.40

No. 3578

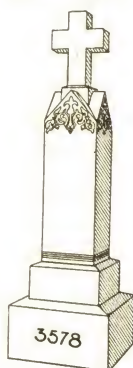

Cross.....1. 0 x 0. 4 x 1.4. .0.5
 Die.....1. 0 x 1. 0 x 3.2. .3.2
 Base.....1. 4 x 1. 4 x 0.8. .1.2
 B. Base....1.10 x 1.10 x 1.0. .3.4
 Weight complete 1400 lbs.; no B. B. 800 lbs.

C.....\$94.50
 D.....84.00
 F.....79.00
 G.....77.00
 H.....74.50
 I.....72.00
 K.....68.50
 L.....65.00

If B. B. is omitted deduct \$11.65

No. 3578¹/₄

Cross....0.10 x 0. 3 x 1. 2. .0. 3
 Die.....0.10 x 0.10 x 2.10. .2. 0
 Base.....1. 2 x 1. 2 x 0. 8. .0.11
 B. Base....1. 6 x 1. 6 x 1. 0. .2. 3
 Weight complete 950 lbs.; no B. B. 545 lbs.

C.....\$67.50
 D.....60.50
 F.....57.50
 G.....56.00
 H.....54.50
 I.....52.50
 K.....50.50
 L.....48.00

If B. B. is omitted deduct \$8.10

No. 3578¹/₂

Cross.....0.8 x 0.3 x 1. 0. .0. 2
 Die.....0.8 x 0.8 x 2. 6. .1. 1
 Base.....1.0 x 1.0 x 0. 6. .0. 6
 B. Base....1.4 x 1.4 x 0.10. .1. 6
 Weight complete 575 lbs.; no B. B. 300 lbs.

C.....\$46.25
 D.....42.50
 F.....40.50
 G.....39.75
 H.....38.75
 I.....38.00
 K.....36.75
 L.....35.25

If B. B. is omitted deduct \$5.40

No. 3579

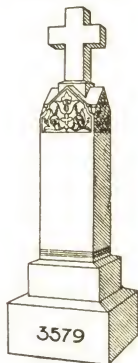

Cross.....1. 0x0. 4x1.4. .0.5
 Die.....1. 0x1. 0x3.2. .3.2
 Base.....1. 4x1. 4x0.8. .1.2
 B. Base.....1.10x1.10x1.0. .3.4
 Weight complete 1400 lbs.; no B. B. 800 lbs.

C.....\$95.50
 D.....85.00
 F.....80.00
 G.....78.00
 H.....75.50
 I.....73.00
 K.....69.50
 L.....66.00

If B. B. is omitted deduct \$11.65

No. 3579¹/₄

Cross.....0.10x0. 3x1. 2. .0. 3
 Die.....0.10x0.10x2.10. .2. 0
 Base.....1. 2x1. 2x0. 8. .0.11
 B. Base.....1. 6x1. 6x1. 0. .2. 3
 Weight complete 950 lbs.; no B. B. 550 lbs.

C.....\$68.50
 D.....61.50
 F.....58.50
 G.....57.00
 H.....55.50
 I.....53.50
 K.....51.50
 L.....49.00

If B. B. is omitted deduct \$8.10

No. 3579¹/₂

Cross.....0.8x0.8x1. 0. .0.2
 Die.....0.8x0.8x2. 6. .1.1
 Base.....1.0x1.0x0. 6. .0.6
 B. Base.....1.4x1.4x0.10. .1.6
 Weight complete 575 lbs.; no B. B. 300 lbs.

C.....\$47.00
 D.....43.25
 F.....41.25
 G.....40.50
 H.....39.50
 I.....38.75
 K.....37.50
 L.....36.00

If B. B. is omitted deduct \$5.40

No. 3580

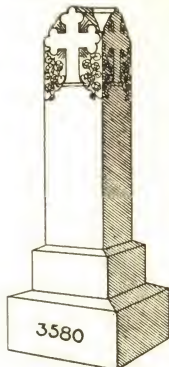

Die.....1. 0x1. 0x3.6. .3.6
 Base.....1. 4x1. 4x0.8. .1.2
 B. Base.....1.10x1.10x1.0. .3.4
 Weight complete 1400 lbs.; no B. B. 800 lbs.

C.....\$90.50
 D.....80.00
 F.....75.00
 G.....73.00
 H.....70.50
 I.....68.00
 K.....64.50
 L.....61.00

If B. B. is omitted deduct \$11.65

No. 3580¹/₄

Die.....0.10x0.10x3.2. .2. 2
 Base.....1. 2x1. 2x0.8. .0.11
 B. Base.....1. 6x1. 6x1.0. .2. 3
 Weight complete 950 lbs.; no B. B. 550 lbs.

C.....\$61.00
 D.....54.00
 F.....51.00
 G.....49.50
 H.....47.75
 I.....46.25
 K.....44.00
 L.....41.75

If B. B. is omitted deduct \$8.10

No. 3580¹/₂

Die.....0.8x0.8x2.8. .1.2
 Base.....1.0x1.0x0.6. .0.6
 B. Base.....1.4x1.4x0.8. .1.2
 Weight complete 500 lbs.; no B. B. 290 lbs.

C.....\$35.75
 D.....32.00
 F.....30.50
 G.....29.50
 H.....28.75
 I.....28.00
 K.....26.75
 L.....25.50

If B. B. is omitted deduct \$4.20

No. 3583

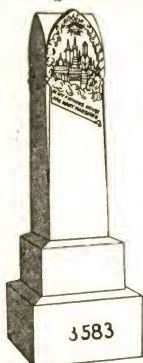

Die.....1. 0 x 1. 0 x 3. 6. . 3. 6
 Base.....1. 4 x 1. 4 x 0. 8. . 1. 2
 B. Base.....1. 10 x 1. 10 x 1. 0. . 3. 4
 Weight complete 1400 lbs.; no B. B. 800 lbs.
 C.....\$89.50
 D.....79.00
 F.....74.00
 G.....72.00
 H.....69.50
 I.....67.00
 K.....63.50
 L.....60.00
 If B. B. is omitted deduct \$11.65.
 If cut parts sand finished deduct \$2.00

No. 3583¹/₄

Die.....0. 10 x 0. 10 x 3. 0. . 2. 1
 Base.....1. 2 x 1. 2 x 0. 8. . 0. 11
 B. Base.....1. 6 x 1. 6 x 1. 0. . 2. 3
 Weight complete 925 lbs.; no B. B. 520 lbs.
 C.....\$61.00
 D.....54.00
 F.....51.00
 G.....49.50
 H.....48.00
 I.....46.50
 K.....44.25
 L.....42.00
 If B. B. is omitted deduct \$8.10.
 If cut parts sand finished deduct \$1.50

No. 3583¹/₂

Die.....0. 8 x 0. 8 x 2. 6. . 1. 1
 Base.....1. 0 x 1. 0 x 0. 6. . 0. 6
 B. Base.....1. 4 x 1. 4 x 0. 10. . 1. 6
 Weight complete 550 lbs.; no B. B. 280 lbs.
 C.....\$35.25
 D.....31.75
 F.....30.25
 G.....29.50
 H.....28.50
 I.....27.75
 K.....26.75
 L.....25.50
 If B. B. is omitted deduct \$5.40.
 If cut parts sand finished deduct \$1.25

No. 3586



Cross.....1. 2 x 0. 6 x 1. 8. . 1. 0
 Die.....1. 6 x 0. 10 x 3. 6. . 4. 5
 Base.....2. 0 x 1. 4 x 0. 10. . 2. 3
 B. Base.....2. 6 x 1. 10 x 1. 2. . 5. 4
 Weight complete 2300 lbs.; no B. B. 1340 lbs.
 C.....\$177.00
 D.....160.00
 F.....152.00
 G.....148.00
 H.....145.00
 I.....141.00
 K.....135.00
 L.....129.00
 If B. B. is omitted deduct \$18.65
 Back plain polished.

No. 3586¹/₄

Cross.....1. 1 x 0. 5 x 1. 6. . 0. 8
 Die.....1. 4 x 0. 8 x 3. 0. . 2. 8
 Base.....1. 9 x 1. 1 x 0. 8. . 1. 3
 B. Base.....2. 2 x 1. 6 x 1. 0. . 3. 3
 Weight complete 1400 lbs.; no B. B. 815 lbs.
 C.....\$127.00
 D.....116.00
 F.....112.00
 G.....109.00
 H.....107.00
 I.....105.00
 K.....101.00
 L.....98.00
 If B. B. is omitted deduct \$11.40
 Back plain polished.

No. 3587



Cross.....1. 2 x 0. 5 x 1.8..0.10
 Die.....1. 6 x 0.10 x 3.6..4. 5
 Base.....1.10 x 1. 2 x 0.8..1. 5
 B. Base...2. 4 x 1. 8 x 1.0..3.11
 Weight complete 1850 lbs.; no B.B.1145 lbs.
 C.....\$136.00
 D.....121.00
 F.....115.00
 G.....111.00
 H.....108.00
 I.....105.00
 K.....99.50
 L.....94.50
 If B. B. is omitted deduct \$13.70

No. 3587¹/₄

Cross.....1.0 x 0.4 x 1.6..0.6
 Die.....1.4 x 0.8 x 3.0..2.8
 Base.....1.8 x 1.0 x 0.8..1.1
 B. Base...2.2 x 1.6 x 1.0..3.3
 Weight complete 1325 lbs.; no B. B. 740 lbs.
 C.....\$95.00
 D.....85.50
 F.....81.50
 G.....79.50
 H.....77.00
 I.....75.00
 K.....72.00
 L.....68.50
 If B. B. is omitted deduct \$11.40

No. 3587¹/₂

Cross.....0.10 x 0. 3 x 1. 4..0.4
 Die.....1. 2 x 0. 6 x 2. 6..1.6
 Base.....1. 6 x 0.10 x 0. 6..0.8
 B. Base...2. 0 x 1. 4 x 0.10..2.3
 Weight complete 825 lbs.; no B. B. 420 lbs.
 C.....\$64.50
 D.....59.00
 F.....56.50
 G.....55.00
 H.....54.00
 I.....52.50
 K.....50.50
 L.....48.75
 If B. B. is omitted deduct \$8.10

No. 3591

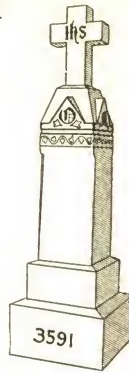

Cross.....1.2 x 0.5 x 1. 8..0.10
 Die.....1.2 x 1.2 x 3. 8..5. 0
 Base.....1.7 x 1.7 x 0.10..2. 1
 B. Base...2.2 x 2.2 x 1. 2..5. 6
 Weight complete 2350 lbs.; no B.B.1360 lbs.
 D.....\$129.00
 H.....113.00
 I.....109.00
 K.....103.00
 L.....97.50
 If B. B. is omitted deduct \$19.25

No. 3591¹/₄

Cross.....1. 0 x 0. 4 x 1.4..0.5
 Die.....1. 0 x 1. 0 x 3.4..3.4
 Base.....1. 4 x 1. 4 x 0.8..1.2
 B. Base...1.10 x 1.10 x 1.0..3.4
 Weight complete 1450 lbs.; no B. B. 850 lbs.
 D.....\$85.00
 H.....75.00
 I.....71.50
 K.....69.00
 L.....64.00
 If B. B. is omitted deduct \$11.65

No. 3591¹/₂

Cross.....0.10 x 0. 3 x 1.2..0. 3
 Die.....0.10 x 0.10 x 3.0..2. 1
 Base.....1. 2 x 1. 2 x 0.8..0.11
 B. Base...1. 6 x 1. 6 x 1.0..2. 3
 Weight complete 950 lbs.; no B. B. 545 lbs.
 D.....\$60.50
 H.....54.00
 I.....52.50
 K.....50.00
 L.....47.50
 If B. B. is omitted deduct \$8.10

No. 3591³/₄

Cross.....0.8 x 0.3 x 1. 0..0.2
 Die.....0.8 x 0.8 x 2. 6..1.1
 Base.....1.0 x 1.0 x 0. 6..0. 6
 B. Base...1.4 x 1.4 x 0.10..1.6
 Weight complete 550 lbs.; no B. B. 280 lbs.
 D.....\$40.00
 H.....36.25
 I.....35.50
 K.....34.25
 L.....32.75
 If B. B. is omitted deduct \$5.40

No. 3595

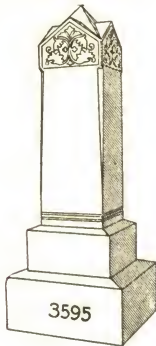

Die.....	1.2 x 1.2 x 3.8	5.0
Base.....	1.7 x 1.7 x 0.10	2.1
B. Base.....	2.2 x 2.2 x 1.2	5.6
Weight complete 2250 lbs.; no B. B. 1260 lbs.		
D.....		\$113.00
H.....		98.00
I.....		95.00
K.....		89.50
L.....		84.00
If B. B. is omitted deduct \$19.25		

No. 3595 $\frac{1}{4}$

Die.....	1.0 x 1.0 x 3.6	3.6
Base.....	1.4 x 1.4 x 0.8	1.2
B. Base.....	1.10 x 1.10 x 1.0	3.4
Weight complete 1400 lbs.; no B. B. 800 lbs.		
D.....		\$76.50
H.....		67.00
I.....		64.50
K.....		61.00
L.....		57.50
If B. B. is omitted deduct \$11.65		

No. 3595 $\frac{1}{2}$

Die.....	0.10 x 0.10 x 3.2	2.2
Base.....	1.2 x 1.2 x 0.8	0.11
B. Base.....	1.6 x 1.6 x 1.0	2.3
Weight complete 950 lbs.; no B. B. 545 lbs.		
D.....		\$54.50
H.....		48.50
I.....		47.00
K.....		44.50
L.....		42.25
If B. B. is omitted deduct \$8.10		

No. 3595 $\frac{3}{4}$

Die.....	0.8 x 0.8 x 2.8	1.2
Base.....	1.0 x 1.0 x 0.6	0.6
B. Base.....	1.4 x 1.4 x 0.10	1.6
Weight complete 550 lbs.; no B. B. 280 lbs.		
D.....		\$33.75
H.....		30.50
I.....		29.75
K.....		28.50
L.....		27.25
If B. B. is omitted deduct \$5.40		

No. 3598

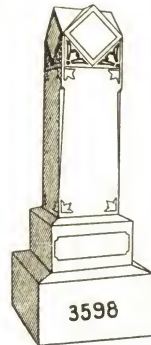

Die.....	1.0 x 1.0 x 3.4	3.4
Base.....	1.4 x 1.4 x 0.10	1.6
B. Base.....	1.10 x 1.10 x 1.0	3.4
Weight complete 1425 lbs.; no B. B. 825 lbs.		
C.....		\$80.00
D.....		78.00
F.....		75.00
G.....		72.50
H.....		70.50
I.....		68.00
K.....		64.00
L.....		60.50
If B. B. is omitted deduct \$11.65		

No. 3598 $\frac{1}{4}$

Die.....	0.10 x 0.10 x 3.0	2.1
Base.....	1.2 x 1.2 x 0.8	0.11
B. Base.....	1.6 x 1.6 x 1.0	2.3
Weight complete 875 lbs.; no B. B. 470 lbs.		
C.....		\$59.50
D.....		52.50
F.....		49.50
G.....		48.00
H.....		46.50
I.....		45.00
K.....		42.75
L.....		40.50
If B. B. is omitted deduct \$8.10		

No. 3598 $\frac{1}{2}$

Die.....	0.8 x 0.8 x 2.6	1.1
Base.....	1.0 x 1.0 x 0.6	0.6
B. Base.....	1.4 x 1.4 x 0.10	1.6
Weight complete 500 lbs.; no B. B. 230 lbs.		
C.....		\$35.25
D.....		31.75
F.....		30.25
G.....		29.50
H.....		28.50
I.....		27.75
K.....		26.75
L.....		25.50
If B. B. is omitted deduct \$5.40		

No. 3599

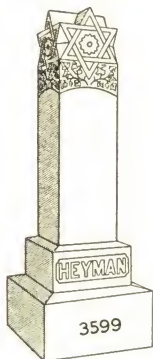

Die.....1. 0x1. 0x3.8..3.8
 Base.....1. 4x1. 4x0.8..1.2
 B. Base....1.10x1.10x1.0..3.4
 Weight complete 1400 lbs.; no B. B. 800 lbs.

C.....	\$90.50
D.....	79.50
F.....	74.50
G.....	72.00
H.....	70.00
I.....	67.50
K.....	63.50
L.....	60.00

If B. B. is omitted deduct \$11.65

No. 3600

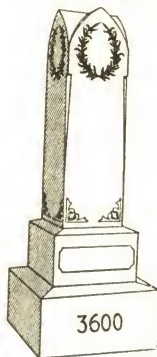

Die.....1. 0x1. 0x3. 4..3.4
 Base.....1. 4x1. 4x0.10..1.6
 B. Base....1.10x1.10x1.0..3.4
 Weight complete 1425 lbs.; no B. B. 825 lbs.

C.....	\$88.50
D.....	77.50
F.....	72.50
G.....	70.00
H.....	68.00
I.....	65.50
K.....	61.50
L.....	58.00

If B. B. is omitted deduct \$11.65

No. 3599¹/₄

Die.....0.10x0.10x3.6..2.5
 Base.....1. 2x1. 2x0.8..0.11
 B. Base....1. 6x1. 6x1.0..2.3
 Weight complete 975 lbs.; no B. B. 570 lbs.

C.....	\$67.00
D.....	59.50
F.....	56.50
G.....	54.50
H.....	53.00
I.....	51.50
K.....	48.75
L.....	46.25

If B. B. is omitted deduct \$8.10

No. 3600¹/₄

Die.....0.10x0.10x3.0..2.1
 Base.....1. 2x1. 2x0.8..0.11
 B. Base....1. 6x1. 6x1.0..2.3
 Weight complete 875 lbs.; no B. B. 470 lbs.

C.....	\$59.00
D.....	52.00
F.....	49.00
G.....	47.50
H.....	46.00
I.....	44.50
K.....	42.25
L.....	40.00

If B. B. is omitted deduct \$8.10

No. 3599¹/₂

Die.....0.8x0.8x2.10..1.3
 Base.....1.0x1.0x0.6..0.6
 B. Base....1.4x1.4x0.10..1.6
 Weight complete 550 lbs.; no B. B. 280 lbs.

C.....	\$39.25
D.....	35.50
F.....	33.50
G.....	32.75
H.....	31.75
I.....	31.00
K.....	29.75
L.....	28.25

If B. B. is omitted deduct \$5.40

No. 3600¹/₂

Die.....0.8x0.8x2. 6..1.1
 Base.....1.0x1.0x0.6..0.6
 B. Base....1.4x1.4x0.10..1.6
 Weight complete 500 lbs.; no B. B. 230 lbs.

C.....	\$33.75
D.....	30.25
F.....	28.75
G.....	28.00
H.....	27.00
I.....	26.25
K.....	25.25
L.....	24.00

If B. B. is omitted deduct \$5.40

No. 3602

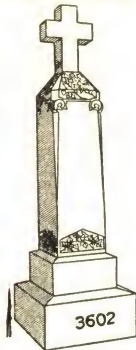

Cross.....	1.	0 x 0.	4 x 1.4.	.0.5
Die.....	1.	0 x 1.	0 x 3.2.	.3.2
Base.....	1.	4 x 1.	4 x 0.8.	.1.2
B. Base.....	1.	1.10 x 1.10	x 1.0.	.3.4
Weight complete 1400 lbs.; no B. B. 800 lbs.				
C.....				\$96.50
D.....				86.00
F.....				81.00
G.....				79.00
H.....				76.50
I.....				74.00
K.....				70.50
L.....				67.00

If B. B. is omitted deduct \$11.65

No. 3602 $\frac{1}{4}$

Cross.....	0.10	x 0.	3 x 1.2.	.0.3
Die.....	0.10	x 0.10	x 3.0.	.2.1
Base.....	1.	2 x 1.	2 x 0.8.	.0.11
B. Base.....	1.	6 x 1.	6 x 1.0.	.2.3
Weight complete 975 lbs.; no B. B. 570 lbs.				
C.....				\$69.00
D.....				61.50
F.....				58.50
G.....				57.00
H.....				55.00
I.....				53.50
K.....				51.00
L.....				48.50

If B. B. is omitted deduct \$8.10

No. 3602 $\frac{1}{2}$

Cross.....	0.8	x 0.3	x 1.0.	.0.2
Die.....	0.8	x 0.8	x 2.6.	.1.1
Base.....	1.0	x 1.0	x 0.6.	.0.6
B. Base.....	1.4	x 1.4	x 0.10.	.1.6
Weight complete 550 lbs.; no B. B. 280 lbs.				
C.....				\$45.00
D.....				41.25
F.....				39.25
G.....				38.50
H.....				37.50
I.....				36.75
K.....				35.50
L.....				34.00

If B. B. is omitted deduct \$5.40

No. 3605

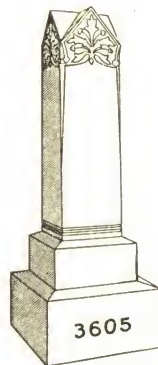

Die.....	1.	0 x 1.	0 x 3.4.	.3.4
Base.....	1.	4 x 1.	4 x 0.8.	.1.2
B. Base.....	1.	1.10 x 1.10	x 1.0.	.3.4
Weight complete 1375 lbs.; no B. B. 775 lbs.				
C.....				\$82.00
D.....				72.00
F.....				67.50
G.....				65.00
H.....				63.00
I.....				60.50
K.....				57.00
L.....				54.00

If B. B. is omitted deduct \$11.65

No. 3605 $\frac{1}{4}$

Die.....	0.10	x 0.10	x 3.0.	.2.1
Base.....	1.	2 x 1.	2 x 0.8.	.0.11
B. Base.....	1.	6 x 1.	6 x 1.0.	.2.3
Weight complete 900 lbs.; no B. B. 495 lbs.				
C.....				\$60.50
D.....				53.50
F.....				50.50
G.....				49.00
H.....				47.50
I.....				46.00
K.....				43.75
L.....				41.50

If B. B. is omitted deduct \$8.10

No. 3605 $\frac{1}{2}$

Die.....	0.8	x 0.8	x 2.6.	.1.1
Base.....	1.0	x 1.0	x 0.6.	.0.6
B. Base.....	1.4	x 1.4	x 0.10.	.1.6
Weight complete 550 lbs.; no B. B. 280 lbs.				
C.....				\$34.75
D.....				31.25
F.....				29.75
G.....				29.00
H.....				28.00
I.....				27.25
K.....				26.25
L.....				25.00

If B. B. is omitted deduct \$5.40

No. 3610

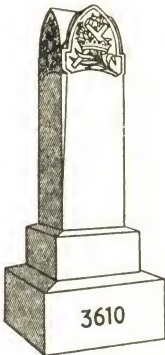

Die.....1. 0x1. 0x3.4..3.4
 Base.....1. 4x1. 4x0.8..1.2
 B. Base....1. 10x1.10x1.0..3.4
 Weight complete 1375 lbs.; no B. B. 775 lbs.

C.....	\$87.50
D.....	77.50
F.....	73.00
G.....	70.50
H.....	68.50
I.....	66.00
K.....	61.50
L.....	59.50

If B. B. is omitted deduct \$11.65

No. 3610¹/₄

Die.....0.10x0.10x3.0..2. 1
 Base.....1. 2x1. 2x0.8..0.11
 B. Base....1. 6x1. 6x1.0..2. 3
 Weight complete 900 lbs.; no B. B. 495 lbs.

C.....	\$61.50
D.....	54.50
F.....	51.50
G.....	50.00
H.....	48.50
I.....	47.00
K.....	44.75
L.....	42.50

If B. B. is omitted deduct \$8.10

No. 3610¹/₂

Die.....0.8x0.8x2. 6..1.1
 Base.....1.0x1.0x0. 6..0.6
 B. Base....1.4x1.4x0.10..1.6
 Weight complete 550 lbs.; no B. B. 280 lbs.

C.....	\$37.25
D.....	33.75
F.....	32.25
G.....	31.50
H.....	30.50
I.....	29.75
K.....	28.75
L.....	27.50

If B. B. is omitted deduct \$5.40

No. 3613



Finial.....0. 8x0. 8x1.0..0.5
 Die.....1. 0x1. 0x3.4..3.4
 Base.....1. 4x1. 4x0.8..1.2
 B. Base....1. 10x1.10x1.0..3.4
 Weight complete 1400 lbs.; no B. B. 800 lbs.

C.....	\$97.50
D.....	86.50
F.....	81.50
G.....	79.00
H.....	76.50
I.....	74.00
K.....	70.50
L.....	67.00

If B. B. is omitted deduct \$11.65

No. 3613¹/₄

Finial....0. 7x0. 7x0.11..0. 4
 Die.....0.10x0.10x3. 2..2. 2
 Base.....1. 2x1. 2x0. 8..0.11
 B. Base...1. 6x1. 6x1. 0..2. 3
 Weight complete 975 lbs.; no B. B. 570 lbs.

C.....	\$75.00
D.....	67.00
F.....	64.00
G.....	62.00
H.....	60.50
I.....	58.50
K.....	56.00
L.....	53.50

If B. B. is omitted deduct \$8.10

No. 3613¹/₂

Finial.....0.6x0.6x0.10..0.3
 Die.....0.8x0.8x2. 8..1.2
 Base.....1.0x1.0x0. 6..0.6
 B. Base....1.4x1.4x0.10..1.6
 Weight complete 600 lbs.; no B. B. 330 lbs.

C.....	\$45.75
D.....	41.50
F.....	39.50
G.....	38.50
H.....	37.50
I.....	36.75
K.....	35.25
L.....	33.75

If B. B. is omitted deduct \$5.40

No. 3614



Cross.....1. 0 x 0. 4 x 1.4..0.5
 Die.....1. 0 x 1. 0 x 3.2..3.2
 Base.....1. 4 x 1. 4 x 0.8..1.2
 B. Base.....1.10 x 1.10 x 1.0..3.4
 Weight complete 1375 lbs.; no B. B. 775 lbs.

C.....\$116.00
 D.....105.00
 F.....101.00
 G.....98.50
 H.....96.00
 I.....93.50
 K.....90.00
 L.....86.50
 If B. B. is omitted deduct \$11.65

No. 3614¹/₄

Cross.....0.10 x 0. 3 x 1.2..0. 3
 Die.....0.10 x 0.10 x 3.0..2. 1
 Base.....1. 2 x 1. 2 x 0.8..0.11
 B. Base...1. 6 x 1. 6 x 1.0..2. 3
 Weight complete 950 lbs.; no B. B. 545 lbs.

C.....\$88.00
 D.....80.50
 F.....77.50
 G.....76.00
 H.....74.00
 I.....72.50
 K.....70.00
 L.....67.50
 If B. B. is omitted deduct \$8.10

No. 3614¹/₂

Cross.....0.8 x 0.3 x 1. 0..0.2
 Die.....0.8 x 0.8 x 2. 6..1.1
 Base.....1.0 x 1.0 x 0. 6..0.6
 B. Base....1.4 x 1.4 x 0.10..1.6
 Weight complete 575 lbs.; no B. B. 305 lbs.

C.....\$57.50
 D.....53.50
 F.....51.50
 G.....51.00
 H.....49.75
 I.....49.00
 K.....47.75
 L.....46.25
 If B. B. is omitted deduct \$5.40

No. 3616

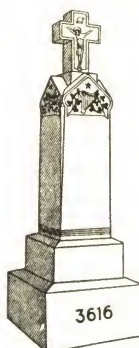

Cross.....1.0 x 0.4 x 1. 4..0. 5
 Die.....1.2 x 1.2 x 3. 4..4. 6
 Base.....1.6 x 1.6 x 0.10..1.11
 B. Base....2.0 x 2.0 x 1. 0..4. 0
 Weight complete 1850 lbs.; no B. B.1130 lbs.

D.....\$121.00
 H.....108.00
 I.....104.00
 K.....99.00
 L.....94.00
 If B. B. is omitted deduct \$14.00

No. 3616¹/₄

Cross.....0.10 x 0. 4 x 1.2..0.4
 Die.....1. 0 x 1. 0 x 3.0..3.0
 Base.....1. 4 x 1. 4 x 0.8..1.2
 B. Base....1.10 x 1.10 x 1.0..3.4
 Weight complete 1300 lbs.; no B. B. 700 lbs.

D.....\$87.00
 H.....78.00
 I.....75.50
 K.....72.00
 L.....69.00
 If B. B. is omitted deduct \$11.65

No. 3616¹/₂

Cross.....0.10 x 0. 3 x 1. 2..0. 3
 Die.....0.10 x 0.10 x 2.10..2. 0
 Base.....1. 2 x 1. 2 x 0. 8..0.11
 B. Base...1. 6 x 1. 6 x 0.10..1.11
 Weight complete 850 lbs.; no B. B. 505 lbs.

D.....\$65.50
 H.....59.50
 I.....57.50
 K.....55.50
 L.....53.00
 If B. B. is omitted deduct \$6.90

No. 3616³/₄

Cross.....0.8 x 0.2 x 1. 0..0.1
 Die.....0.8 x 0.8 x 2. 6..1.1
 Base.....1.0 x 1.0 x 0. 6..0.6
 B. Base....1.4 x 1.4 x 0.10..1.6
 Weight complete 500 lbs.; no B. B. 230 lbs.

D.....\$44.75
 H.....41.50
 I.....40.50
 K.....39.50
 L.....38.25
 If B. B. is omitted deduct \$5.40

No. 3617

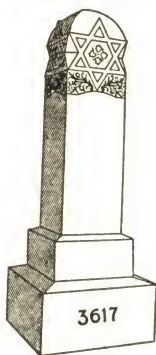

Die.....1. 0x1. 0x3.8..3.8
 Base.....1. 4x1. 4x0.8..1.2
 B. Base....1.10x1.10x1.0..3.4
 Weight complete 1400 lbs.; no B. B. 800 lbs.

C.....\$90.50
 D.....79.50
 F.....74.50
 G.....72.00
 H.....70.00
 I.....67.50
 K.....63.50
 L.....60.00

If B. B. is omitted deduct \$11.65

No. 3617¹/₄

Die.....0.10x0.10x3.6..2.5
 Base.....1. 2x1. 2x0.8..0.11
 B. Base....1. 6x1. 6x1.0..2.3
 Weight complete 975 lbs.; no B. B. 570 lbs.

C.....\$67.00
 D.....59.50
 F.....56.50
 G.....54.50
 H.....53.00
 I.....51.50
 K.....48.75
 L.....46.25

If B. B. is omitted deduct \$8.10

No. 3617¹/₂

Die.....0.8x0.8x2.10..1.3
 Base.....1.0x1.0x0.6..0.6
 B. Base....1.4x1.4x0.10..1.6
 Weight complete 550 lbs.; no B. B. 280 lbs.

C.....\$39.25
 D.....35.50
 F.....33.50
 G.....32.75
 H.....31.75
 I.....31.00
 K.....29.75
 L.....28.25

If B. B. is omitted deduct \$5.40

No. 3631

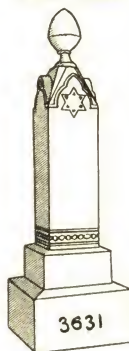

Finial.....0.9x0.9x1.3..0.8
 Die.....1.2x1.2x3.10..5.3
 Base.....1.6x1.6x0.8..1.6
 B. Base....2.0x2.0x1.2..4.8
 Weight complete 2050 lbs.; no B. B. 1210 lbs.

D.....\$126.00
 F.....118.00
 G.....115.00
 H.....111.00
 I.....107.00
 K.....102.00
 L.....96.00

If B. B. is omitted deduct \$16.35

No. 3631¹/₄

Finial.....0.8x0.8x1.2..0.6
 Die.....1.0x1.0x3.6..3.6
 Base.....1.4x1.4x0.8..1.2
 B. Base....1.10x1.10x1.0..3.4
 Weight complete 1425 lbs.; no B. B. 825 lbs.

D.....\$90.50
 F.....85.50
 G.....83.00
 H.....80.50
 I.....77.50
 K.....74.00
 L.....70.00

If B. B. is omitted deduct \$11.65

No. 3631¹/₂

Finial.....0.7x0.7x1.0..0.4
 Die.....0.10x0.10x3.2..2.2
 Base.....1.2x1.2x0.8..0.11
 B. Base....1.6x1.6x1.0..2.3
 Weight complete 950 lbs.; no B. B. 545 lbs.

D.....\$68.00
 F.....65.00
 G.....63.00
 H.....61.50
 I.....59.50
 K.....57.00
 L.....54.50

If B. B. is omitted deduct \$8.10

No. 3663

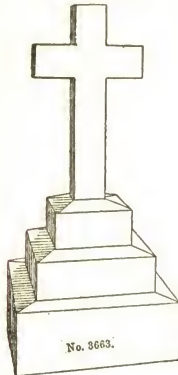

Cross.....	1.6 x 0.4 x 2.6	1.3
Base.....	1.0 x 0.11 x 0.6	0.6
Base.....	1.6 x 1.5 x 0.6	1.1
B. Base.....	2.0 x 1.11 x 0.8	2.7
Weight complete 850 lbs.; no B. B. 385 lbs.		
C.....		\$64.50
D.....		58.00
F.....		55.00
G.....		53.50
H.....		52.50
I.....		51.00
K.....		48.75
L.....		46.50
If B. B. is omitted deduct \$9.30		

No. 3666



Cross.....	2.6 x 1.0 x 4.6	11.3
Plinth.....	2.2 x 1.6 x 0.7	1.11
Die.....	2.9 x 2.0 x 2.0	11.0
B. Base.....	3.5 x 2.8 x 1.2	10.8
Weight complete 5300 lbs.; no B.B. 3380 lbs.		
C..	\$922.00	H.. \$820.00
D..	868.00	I... 808.00
F..	844.00	K... 790.00
G..	832.00	L... 771.00
If B. B. is omitted deduct \$37.35		

No. 3671 1/4



Cross.....	1.3 x 0.5 x 2.5	1.3
B. Base.....	1.8 x 0.10 x 0.8	0.11
Weight complete 375 lbs.; no B. B. 210 lbs.		
C.....		\$56.00
D.....		53.00
F.....		52.00
G.....		51.50
H.....		50.50
I.....		50.00
K.....		49.00
L.....		48.00
If B. B. is omitted deduct \$3.45		

No. 3673

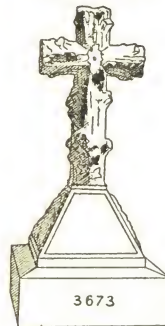

Cross.....	2.0 x 0.8 x 3.6	4.8
Base.....	2.0 x 2.0 x 1.4	5.4
B. Base.....	2.6 x 2.6 x 1.0	6.3
Weight complete 2350 lbs.; no B.B. 1225 lbs.		
Rutland White, Riv., S. F., Blue or P. V..... \$115.00		
If B. B. is omitted deduct \$21.90		

No. 3673 1/4

Cross.....	1.10 x 0.6 x 3.0	2.9
Base.....	1.10 x 1.10 x 1.2	3.11
B. Base.....	2.4 x 2.4 x 1.0	5.1
Weight complete 1800 lbs.; no B. B. 885 lbs.		
Rutland White, Riv., S. F., Blue or P. V..... \$85.00		
If B. B. is omitted deduct \$17.80		

No. 3674

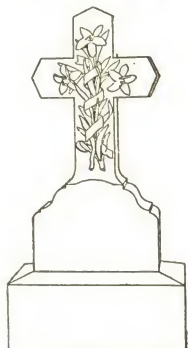

Cross.....1. 4 x 0.6 x 2.10..1.11
 B. Base...1.10 x 1.0 x 0.10..1. 6
 Weight complete 525 lbs.; no B. B. 255 lbs.

- C.....\$93.50
 - D.....78.50
 - F.....71.50
 - G.....68.50
 - H.....65.00
 - I.....61.50
 - K.....56.50
 - L.....51.50
- If B. B. is omitted deduct \$5.40

No. 3679

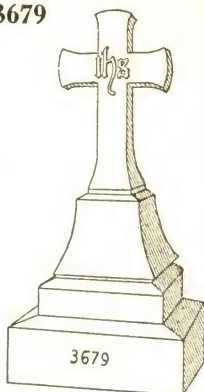

Cross.....1. 8 x 0. 8 x 2.8..3.0
 Die.....1. 6 x 1. 6 x 1.2..2.8
 Base.....1.10 x 1.10 x 0.6..1.8
 B. Base....2. 4 x 2. 4 x 1.0..5.5
 Weight complete 1950 lbs.; no B. B. 975 lbs.

- C..\$175.00 H...\$144.00
 - D.. 159.00 I... 140.00
 - F.. 151.00 K... 135.00
 - G.. 148.00 L... 129.00
- If B. B. is omitted deduct \$18.95

No. 3675



Cross.....1. 4 x 0.6 x 2.10..1.11
 B. Base...1.10 x 1.0 x 0.10..1. 6
 Weight complete 525 lbs.; no B. B. 255 lbs.

- C.....\$93.50
 - D.....78.50
 - F.....71.50
 - G.....68.50
 - H.....65.00
 - I.....61.50
 - K.....56.00
 - L.....51.00
- If B. B. is omitted deduct \$5.40

No. 3680

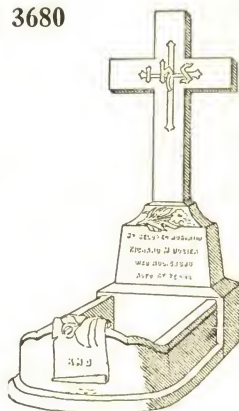

Cross.....2.8 x 0.8 x 4.0..7.1
 Die.....2.0 x 1.8 x 1.8..5.7
 B. Base....2.8 x 2.4 x 1.0..6.3
 2 Sides....5.0 x 0.3 x 0.8..1.8
 Foot.....2.5 x 1.2 x 1.2..3.3
 B. Slab....6.3 x 2.8 x 0.2..2.9

- C..\$410.00 H...\$326.00
 - D.. 361.00 I... 317.00
 - F.. 343.00 K... 304.00
 - G.. 332.00 L... 291.00
- If B. B. is omitted deduct \$31.50

Above prices based on Bottom Base and Bottom Slab of inferior marble sand finished.

No. 3691

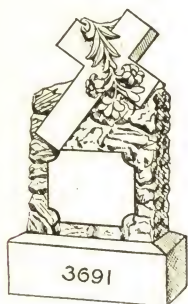

Die.....2.0 x 1.0 x 3.6..7.0
 B. Base.....2.6 x 1.6 x 1.0..3.9

Weight complete 1700 lbs.; no B. B. 1025 lbs.

C.....	\$186.00
D.....	171.00
F.....	164.00
G.....	160.00
H.....	157.00
I.....	153.00
K.....	148.00
L.....	143.00

If B. B. is omitted deduct \$13.15

No. 3695

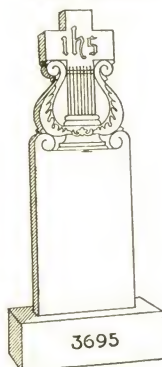

Die.....1.2 x 0.4 x 3.6..1.4
 B. Base.....1.8 x 0.10 x 0.8..0.11

Weight complete 330 lbs.; no B. B. 180 lbs.

D.....	\$31.75
H.....	29.00
I.....	28.25
K.....	27.25
L.....	26.25

If B. B. is omitted deduct \$3.45

Face only polished; edges and back sand finished.

Mortise in bottom base \$1.75 extra.

No. 3691¹/₄

Die.....1.8 x 0.10 x 3.0..4.2
 B. Base.....2.2 x 1.4 x 1.0..2.11

Weight complete 1100 lbs.; no B. B. 590 lbs.

C.....	\$132.00
D.....	123.00
F.....	119.00
G.....	117.00
H.....	115.00
I.....	113.00
K.....	110.00
L.....	106.00

If B. B. is omitted deduct \$10.50

No. 3695¹/₂

Die.....1.0 x 0.4 x 2.6..0.10
 B. Base.....1.6 x 0.10 x 0.8..0.10

Weight complete 250 lbs.; no B. B. 115 lbs.

D.....	\$25.25
H.....	23.50
I.....	23.00
K.....	22.00
L.....	21.25

If B. B. is omitted deduct \$3.15

Face only polished; edges and back sand finished.

Mortise in bottom base \$1.35 extra

No. 3698



Cross.....1.6 x 0.8 x 2.6..2. 6
 Die.....1.8 x 1.6 x 2.4..5.10
 B. Base.....2.2 x 2.0 x 1.0..4. 4

Weight complete 1900 lbs.; no B. B. 1120 lbs.

Rutland White,
 Riv., S. F., Blue
 or P. V.....\$118.00
 If B. B. is omitted deduct \$15.15

No. 3700

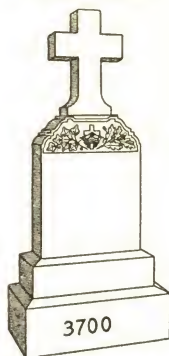

Cross.....1.0 x 0.4 x 1. 6..0.6
 Die.....1.6 x 0.6 x 2. 0..1.6
 Base.....1.9 x 0.9 x 0. 5..0.7
 B. Base.....2.2 x 1.2 x 0.10..2.1

Weight complete 775 lbs.; no B. B. 400 lbs.

C.....\$62.00
 D.....56.50
 F.....53.50
 G.....52.50
 H.....51.00
 I.....49.75
 K.....48.00
 L.....46.00

If B. B. is omitted deduct \$7.50
 Back plain polished

No. 3698 1/4

Cross.....1. 4 x 0.6 x 2. 4..1. 7
 Die.....1. 4 x 1.2 x 1.10..2.10
 B. Base....1.10 x 1.8 x 1. 0..3. 1

Weight complete 1100 lbs.; no B. B. 545 lbs.

Rutland White,
 Riv., S. F., Blue
 or P. V.....\$74.00

If B. B. is omitted deduct \$10.35

No. 3700 1/4

Cross.....1.0 x 0.3 x 1. 4..0. 4
 Die.....1.6 x 0.4 x 2. 0..1. 0
 Base.....1.9 x 0.7 x 0. 4..0. 4
 B. Base....2.2 x 1.0 x 0.10..1.10

Weight complete 575 lbs.; no B. B. 245 lbs.

C.....\$45.25
 D.....41.50
 F.....40.00
 G.....39.00
 H.....38.25
 I.....37.50
 K.....36.25
 L.....35.00

If B. B. is omitted deduct \$6.60
 Back plain polished

No. 3701

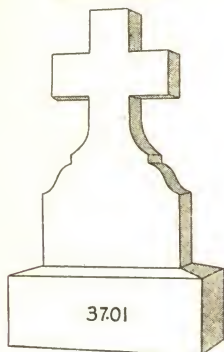

Cross.....1.6 x 0.4 x 2.10..1.5
 B. Base.....2.0 x 0.10 x 0.10..1.5
 Weight complete 450 lbs.; no B. B. 195 lbs.

C.....	\$35.75
D.....	32.50
F.....	31.00
G.....	30.25
H.....	29.50
I.....	29.00
K.....	27.75
L.....	26.75

If B. B. is omitted deduct \$5.10

Face only polished; balance sand finished.

If back is polished, extra \$1.50.

If back and edges are polished, extra \$3.75.

No. 3701 $\frac{1}{4}$

Cross.....1.4 x 0.4 x 2.6..1.1
 B. Base.....1.9 x 0.9 x 0.10..1.1
 Weight complete 350 lbs.; no B. B. 155 lbs.

C.....	\$27.50
D.....	25.00
F.....	24.00
G.....	23.50
H.....	22.75
I.....	22.25
K.....	21.50
L.....	20.75

If B. B. is omitted deduct \$3.90

Face only polished; balance sand finished.

If back is polished, extra \$1.25.

If back and edges are polished, extra \$3.00.

No. 3701 $\frac{1}{2}$

Cross.....1.2 x 0.4 x 2.0..0.9
 B. Base.....1.7 x 0.9 x 0.8..0.10
 Weight complete 250 lbs.; no B. B. 100 lbs.

C.....	\$21.25
D.....	19.75
F.....	18.75
G.....	18.50
H.....	18.00
I.....	17.75
K.....	17.25
L.....	16.50

If B. B. is omitted deduct \$3.15

Face only polished; balance sand finished.

If back is polished, extra \$1.00.

If back and edges are polished, extra \$2.50.

No. 3702

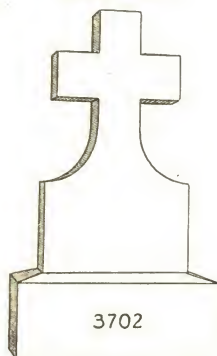

Same sizes, prices and finish as No. 3701.

No. 3702 $\frac{1}{4}$

Same sizes, prices and finish as No. 3701 $\frac{1}{4}$.

No. 3702 $\frac{1}{2}$

Same sizes, prices and finish as No. 3701 $\frac{1}{2}$.

No. 3703

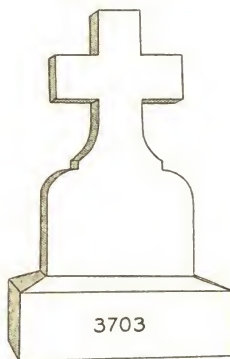

Same sizes, prices and finish as No. 3701.

No. 3703 $\frac{1}{4}$

Same sizes, prices and finish as No. 3701 $\frac{1}{4}$.

No. 3703 $\frac{1}{2}$

Same sizes, prices and finish as No. 3701 $\frac{1}{2}$.

No. 3704

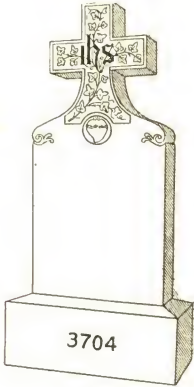

Die.....2.2 x 0.8 x 4.6 . . 6.6
 B. Base.....2.8 x 1.2 x 1.0 . . 3.1
 Weight complete 1450 lbs.; no B. B. 900 lbs.

D.....	\$110.00
G.....	101.00
H.....	97.50
I.....	94.00
K.....	89.00
L.....	84.50

If B. B. is omitted deduct \$10.80
 Back plain polished

No. 3704¹/₄

Die.....1.10 x 0.6 x 3.10 . . 3.6
 B. Base.....2.4 x 1.0 x 0.10 . . 1.11
 Weight complete 825 lbs.; no B. B. 480 lbs.

D.....	\$69.50
G.....	64.00
H.....	62.50
I.....	60.50
K.....	58.00
L.....	55.50

If B. B. is omitted deduct \$6.90
 Back plain polished

No. 3704¹/₂

Die.....1.8 x 0.6 x 3.6 . . 2.11
 B. Base.....2.2 x 1.0 x 0.10 . . 1.10
 Weight complete 725 lbs.; no B. B. 400 lbs.

D.....	\$61.50
G.....	57.00
H.....	55.50
I.....	54.00
K.....	52.00
L.....	49.75

If B. B. is omitted deduct \$6.60
 Back plain polished

No. 3704³/₄

Die.....1.6 x 0.4 x 3.0 . . 1.6
 B. Base.....2.0 x 0.10 x 0.10 . . 1.5
 Weight complete 450 lbs.; no B. B. 200 lbs.

D.....	\$38.50
G.....	35.25
H.....	34.00
I.....	32.75
K.....	30.75
L.....	29.00

If B. B. is omitted deduct \$5.10
 Back plain polished

No. 3705

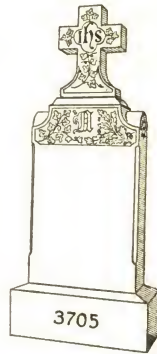

Cross.....1.3 x 0.5 x 1.10 . . 0.11
 Die.....2.2 x 0.10 x 3.6 . . 6.4
 B. Base.....2.10 x 1.6 x 1.2 . . 5.0
 Weight complete 2050 lbs.; no B. B. 1150 lbs.

C.....	\$145.00
D.....	129.00
F.....	121.00
G.....	118.00
H.....	114.00
I.....	111.00
K.....	105.00
L.....	99.50

If B. B. is omitted deduct \$17.50
 Back plain polished

No. 3705¹/₄

Cross.....1.2 x 0.4 x 1.8 . . 0.8
 Die.....2.0 x 0.8 x 3.6 . . 4.8
 B. Base.....2.6 x 1.2 x 1.0 . . 2.11
 Weight complete 1350 lbs.; no B. B. 825 lbs.

C.....	\$107.00
D.....	94.50
F.....	89.50
G.....	86.50
H.....	84.00
I.....	81.50
K.....	77.50
L.....	73.50

If B. B. is omitted deduct \$10.50
 Back plain polished

No. 3705¹/₂

Cross.....0.10 x 0.3 x 1.2 . . 0.3
 Die.....1.8 x 0.6 x 2.8 . . 2.3
 B. Base.....2.2 x 1.0 x 0.10 . . 1.10
 Weight complete 750 lbs.; no B. B. 420 lbs.

C.....	\$61.50
D.....	56.00
F.....	53.50
G.....	52.00
H.....	51.00
I.....	49.50
K.....	47.50
L.....	45.75

If B. B. is omitted deduct \$6.60
 Back plain polished

No. 3706

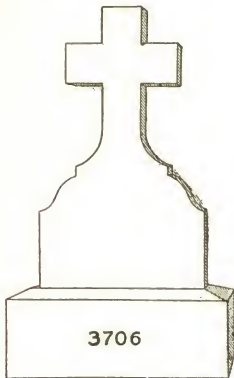

Cross.....1.6 x 0. 4 x 2. 6. .1.3
 B. Base.....2.0 x 0.10 x 0.10. .1.5
 Weight complete 425 lbs.; no B. B. 170 lbs.

C.....	\$34.00
D.....	31.25
F.....	29.75
G.....	29.25
H.....	28.50
I.....	28.00
K.....	27.00
L.....	26.00

If B. B. is omitted deduct \$5.10
 * Face only polished; balance sand finished.
 If back is polished, extra \$1.50.
 If back and edges are polished, extra \$3.75.

No. 3706 $\frac{1}{4}$

Cross.....1.4 x 0.4 x 2. 4. .1.0
 B. Base.....1.9 x 0.9 x 0.10. .1.1
 Weight complete 325 lbs.; no B. B. 130 lbs.

C.....	\$27.50
D.....	25.25
F.....	24.25
G.....	23.75
H.....	23.25
I.....	22.75
K.....	22.00
L.....	21.25

If B. B. is omitted deduct \$3.90
 Face only polished; balance sand finished.
 If back is polished, extra \$1.25.
 If back and edges are polished, extra \$3.00.

No. 3706 $\frac{1}{2}$

Cross.....1.4 x 0.3 x 2.4. .0.9
 B. Base.....1.9 x 0.8 x 0.8. .0.9
 Weight complete 225 lbs.; no B. B. 90 lbs.

C.....	\$21.25	H.....	\$18.00
D.....	19.75	I.....	17.75
F.....	18.75	K.....	17.25
G.....	18.50	L.....	16.50

If B. B. is omitted deduct \$2.80
 Face only polished; balance sand finished.
 If back is polished, extra \$1.25.
 If back and edges are polished, extra \$2.75.

No. 3707

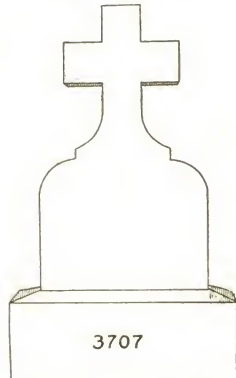

Same sizes, prices and finish as No. 3706.

No. 3707 $\frac{1}{4}$

Same sizes, prices and finish as No. 3706 $\frac{1}{4}$.

No. 3707 $\frac{1}{2}$

Same sizes, prices and finish as No. 3706 $\frac{1}{2}$.

No. 3708

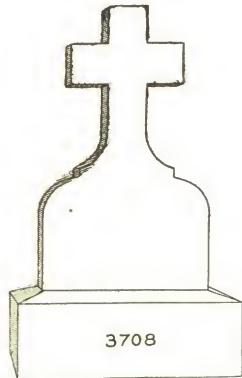

Same sizes, prices and finish as No. 3706.

No. 3708 $\frac{1}{4}$

Same sizes, prices and finish as No. 3706 $\frac{1}{4}$.

No. 3708 $\frac{1}{2}$

Same sizes, prices and finish as No. 3706 $\frac{1}{2}$.

No. 3709

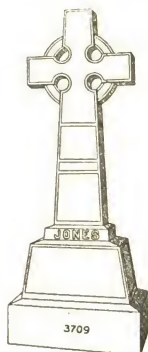

Cross..... 2.9 x 0.10 x 6. 0.. 13.9
 Die..... 2.8 x 1. 8 x 1.10.. 8.2
 B.Ba.(S.S.) 3.4 x 2. 2 x 1. 2.. 8.5

Weight complete 4300 lbs.

D.....	\$321.00
H.....	277.00
I.....	266.00
K.....	250.00
L.....	234.00

M. M. finish

No. 3709¹/₄

Cross..... 2.6 x 0.8 x 5.0.. 8.4
 Die..... 2.6 x 1.6 x 1.8.. 6.3
 B.Ba.(S.S.)... 3.0 x 2.0 x 1.2.. 7.0

Weight complete 3100 lbs.

D.....	\$240.00
H.....	211.00
I.....	204.00
K.....	193.00
L.....	182.00

M. M. finish

No. 3709¹/₂

Cross..... 2.0 x 0.6 x 4.0.. 4.0
 Die..... 2.0 x 1.2 x 1.4.. 3.1
 B. Ba.(S.S.)... 2.4 x 1.6 x 1.0.. 3.6

Weight complete 1500 lbs.

D.....	\$131.00
H.....	117.00
I.....	113.00
K.....	108.00
L.....	103.00

M. M. finish

No. 3712

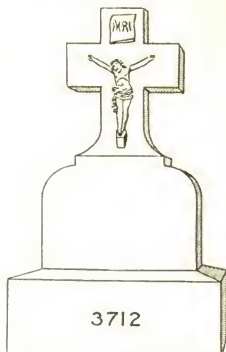

Cross..... 1.8 x 0.8 x 3.0.. 3.4
 B. Base..... 2.2 x 1.2 x 1.0.. 2.6

Weight complete 900 lbs.; no B. B. 450 lbs.

D.....	\$88.50
F.....	85.00
G.....	83.00
H.....	81.50
I.....	80.00
K.....	77.50
L.....	75.00

If B. B. is omitted deduct \$9.00
 All polished. If back is sand finished deduct \$1.50.

No. 3712¹/₄

Cross..... 1.6 x 0.6 x 2. 6.. 1.11
 B. Base..... 2.0 x 1.0 x 0.10.. 1. 8

Weight complete 550 lbs.; no B. B. 250 lbs.

D.....	\$60.00
F.....	58.00
G.....	57.00
H.....	56.00
I.....	55.00
K.....	53.50
L.....	52.50

If B. B. is omitted deduct \$6.00
 All polished. If back is sand finished deduct \$1.25.

No. 3712¹/₂

Cross..... 1. 4 x 0. 4 x 2.6.. 1.1
 B. Base..... 1.10 x 0.10 x 0.8.. 1.0

Weight complete 325 lbs.; no B. B. 145 lbs.

D.....	\$45.50
F.....	44.50
G.....	44.00
H.....	43.25
I.....	42.75
K.....	42.00
L.....	41.25

If B. B. is omitted deduct \$3.75
 All polished. If back is sand finished deduct \$1.00.

No. 3713

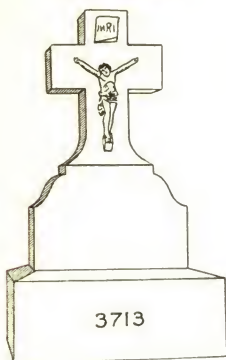

Cross.....1.8 x 0.8 x 3.0..3.4
 B. Base.....2.2 x 1.2 x 1.0..2.6
 Weight complete 900 lbs.; no B. B. 450 lbs.

D.....	\$88.50
F.....	85.00
G.....	83.00
H.....	81.50
I.....	80.00
K.....	77.50
L.....	75.00

If B. B. is omitted deduct \$9.00
 All polished. If back is sand finished
 deduct \$1.50.

No. 3713 $\frac{1}{4}$

Cross.....1.6 x 0.6 x 2.6..1.11
 B. Base.....2.0 x 1.0 x 0.10..1.8
 Weight complete 550 lbs.; no B. B. 250 lbs.

D.....	\$60.00
F.....	58.00
G.....	57.00
H.....	56.00
I.....	55.00
K.....	53.50
L.....	52.50

If B. B. is omitted deduct \$6.00
 All polished. If back is sand finished
 deduct \$1.25.

No. 3713 $\frac{1}{2}$

Cross.....1.4 x 0.4 x 2.6..1.1
 B. Base.....1.10 x 0.10 x 0.8..1.0
 Weight complete 325 lbs.; no B. B. 145 lbs.

D.....	\$45.50
F.....	44.50
G.....	44.00
H.....	43.25
I.....	42.75
K.....	42.00
L.....	41.25

If B. B. is omitted deduct \$3.75
 All polished. If back is sand finished
 deduct \$1.00.

No. 3718

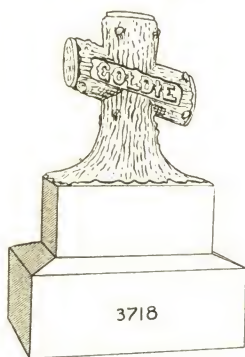

Cross.....1.2 x 0.8 x 1.8..1.4
 B. Base.....1.6 x 1.0 x 0.8..1.0
 Weight complete 325 lbs.; no B. B. 145 lbs.

C.....	\$32.75
D.....	29.75
F.....	28.25
G.....	27.75
H.....	27.00
I.....	26.25
K.....	25.25
L.....	24.25

If B. B. is omitted deduct \$3.75
 Face only polished

No. 3718 $\frac{1}{4}$

Cross.....1.0 x 0.6 x 1.6..0.9
 B. Base.....1.4 x 0.10 x 0.8..0.9
 Weight complete 200 lbs.; no B. B. 65 lbs.

C.....	\$20.25
D.....	18.75
F.....	17.75
G.....	17.50
H.....	17.00
I.....	16.75
K.....	16.25
L.....	15.50

If B. B. is omitted deduct \$2.80
 Face only polished

No. 3718 $\frac{1}{2}$

Cross.....1.0 x 0.4 x 1.6..0.6
 B. Base.....1.4 x 0.8 x 0.8..0.7
 Weight complete 150 lbs.; no B. B. 50 lbs.

C.....	\$16.25
D.....	15.00
F.....	14.50
G.....	14.25
H.....	14.00
I.....	13.75
K.....	13.25
L.....	13.00

If B. B. is omitted deduct \$2.20
 Face only polished

No. 3719

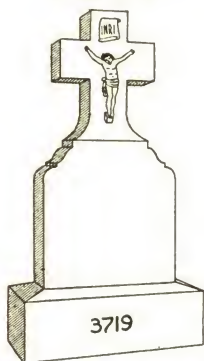

Cross.....1.8x0.8x3.6..3.11
 B. Base.....2.2x1.2x1.0..2.6
 Weight complete 1000 lbs.; no B. B. 550 lbs.

C.....	\$106.00
D.....	97.50
F.....	93.50
G.....	91.50
H.....	89.50
I.....	87.50
K.....	84.50
L.....	82.00

If B. B. is omitted deduct \$9.00
 All polished. If face only is polished,
 deduct \$4.50.

No. 3719¹/₄

Cross.....1.6x0.6x3.0..2.8
 B. Base.....2.0x1.0x0.10..1.3
 Weight complete 600 lbs.; no B. B. 300 lbs.

C.....	\$67.50
D.....	62.50
F.....	60.50
G.....	59.50
H.....	58.00
I.....	57.00
K.....	55.50
L.....	53.50

If B. B. is omitted deduct \$6.00
 All polished. If face only is polished
 deduct \$3.75.

No. 3719¹/₂

Cross.....1.4x0.4x2.10..1.3
 B. Base.....1.10x0.10x0.8..1.0
 Weight complete 350 lbs.; no B. B. 170 lbs.

C.....	\$50.50
D.....	48.00
F.....	46.50
G.....	46.00
H.....	45.25
I.....	44.75
K.....	43.75
L.....	42.75

If B. B. is omitted deduct \$3.75
 All polished. If face only is polished
 deduct \$3.00.

No. 3720

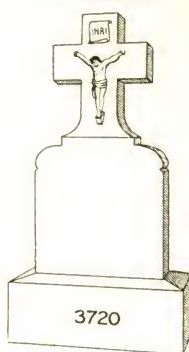

Cross.....1.8x0.8x3.6..3.11
 B. Base.....2.2x1.2x1.0..2.6
 Weight complete 1000 lbs.; no B. B. 550 lbs.

C.....	\$106.00
D.....	97.50
F.....	93.50
G.....	91.50
H.....	89.50
I.....	87.50
K.....	84.50
L.....	82.00

If B. B. is omitted deduct \$9.00
 All polished. If face only is polished
 deduct \$4.50.

No. 3720¹/₄

Cross.....1.6x0.6x3.0..2.3
 B. Base.....2.0x1.0x0.10..1.8
 Weight complete 600 lbs.; no B. B. 300 lbs.

C.....	\$67.50
D.....	62.50
F.....	60.50
G.....	59.50
H.....	58.00
I.....	57.00
K.....	55.50
L.....	53.50

If B. B. is omitted deduct \$6.00
 All polished. If face only is polished
 deduct \$3.75.

No. 3720¹/₂

Cross.....1.4x0.4x2.10..1.3
 B. Base.....1.10x0.10x0.8..1.0
 Weight complete 350 lbs.; no B. B. 170 lbs.

C.....	\$50.50
D.....	48.00
F.....	46.50
G.....	46.00
H.....	45.25
I.....	44.75
K.....	43.75
L.....	42.75

If B. B. is omitted deduct \$3.75
 All polished. If face only is polished
 deduct \$3.00.

No. 3721

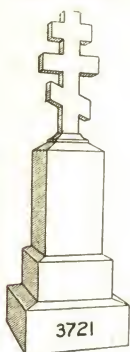

Cross.....	1.2 x 0.4 x 2.6	.1.0
Die.....	1.2 x 1.2 x 2.4	.3.2
Base.....	1.6 x 1.6 x 0.8	.1.6
B. Base.....	2.0 x 2.0 x 1.0	.4.0
Weight complete 1600 lbs.; no B. B. 880 lbs.		
D.....		\$102.00
F.....		96.00
G.....		93.50
H.....		90.50
I.....		87.50
K.....		83.50
L.....		79.00

If B. B. is omitted deduct \$14.00

Cross polished face and back, edges sand finished. Cut parts of die and base sand finished.

No. 3721¹/₄

Cross.....	1.0 x 0.4 x 2.2	.0.9
Die.....	1.0 x 1.0 x 2.2	.2.2
Base.....	1.4 x 1.4 x 0.8	.1.2
B. Base.....	1.10 x 1.10 x 1.0	.3.4
Weight complete 1250 lbs.; no B. B. 650 lbs.		
D.....		\$80.00
F.....		76.00
G.....		74.00
H.....		72.00
I.....		70.00
K.....		66.50
L.....		63.50

If B. B. is omitted deduct \$11.65

Cross polished face and back, edges sand finished. Cut parts of die and base sand finished.

No. 3721¹/₂

Cross.....	0.10 x 0.3 x 1.8	.0.4
Die.....	0.10 x 0.10 x 2.0	.1.5
Base.....	1.2 x 1.2 x 0.8	.0.11
B. Base.....	1.6 x 1.6 x 0.10	.1.11
Weight complete 800 lbs.; no B. B. 450 lbs.		
D.....		\$57.00
F.....		54.00
G.....		53.00
H.....		51.50
I.....		50.00
K.....		48.25
L.....		46.25

If B. B. is omitted deduct \$6.90

Cross polished face and back, edges sand finished. Cut parts of die and base sand finished.

No. 3722

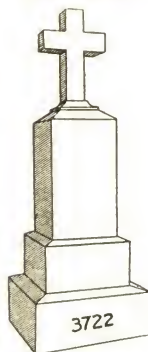

Cross.....	1.2 x 0.4 x 1.8	.0.8
Die.....	1.2 x 1.2 x 2.4	.3.2
Base.....	1.6 x 1.6 x 0.8	.1.6
B. Base.....	2.0 x 2.0 x 1.0	.4.0
Weight complete 1600 lbs.; no B. B. 860 lbs.		
D.....		\$89.50
F.....		84.50
G.....		81.50
H.....		79.00
I.....		76.50
K.....		72.50
L.....		68.50

If B. B. is omitted deduct \$14.00

Cut parts of die and base sand finished

No. 3722¹/₄

Cross.....	1.0 x 0.4 x 1.6	.0.6
Die.....	1.0 x 1.0 x 2.2	.2.2
Base.....	1.4 x 1.4 x 0.8	.1.2
B. Base.....	1.10 x 1.10 x 1.0	.3.4
Weight complete 1250 lbs.; no B. B. 650 lbs.		
D.....		\$68.00
F.....		64.00
G.....		62.00
H.....		60.50
I.....		58.50
K.....		55.50
L.....		52.50

If B. B. is omitted deduct \$11.65

Cut parts of die and base sand finished

No. 3722¹/₂

Cross.....	0.10 x 0.3 x 1.2	.0.3
Die.....	0.10 x 0.10 x 2.0	.1.5
Base.....	1.2 x 1.2 x 0.8	.0.11
B. Base.....	1.6 x 1.6 x 0.10	.1.11
Weight complete 800 lbs.; no B. B. 480 lbs.		
D.....		\$48.25
F.....		45.75
G.....		44.50
H.....		43.00
I.....		41.75
K.....		40.00
L.....		38.00

If B. B. is omitted deduct \$6.90

Cut parts of die and base sand finished

No. 3723

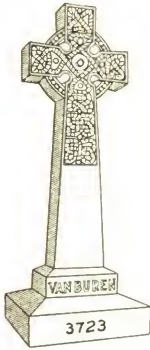

Cross.....3.2 x 0.11 x 8.4. 24. 2
 Base.....2.3 x 1. 7³/₈ x 0.9. 2. 8
 B. Ba.(S.S.) 3.8 x 3. 0 x 1.2. 12. 10

Weight complete 5000 lbs.; no B. B. 2690 lbs.

- D.....\$505.00
- H.....451.00
- I.....438.00
- K.....418.00
- L.....398.00

M. M. finish. Carved on face only.

No. 3723¹/₄

Cross.....2.6 x 0.8 x 5.0. .8.4
 Base.....1.8 x 1.2³/₈ x 0.8. .1.4
 B. Ba(S.S.)...3.0 x 2.6 x 1.0. .7.6

Weight complete 2500 lbs.; no B. B. 1150 lbs.

- D.....\$258.00
- H.....239.00
- I.....234.00
- K.....227.00
- L.....220.00

M. M. finish. Carved on face only

No. 3723¹/₂

Cross.....2.0 x 0.6 x 4.0. .4.0
 Base.....1.6 x 1.0³/₈ x 0.8. .1.0
 B. Ba(S.S.)...2.6 x 2.0 x 1.0. .5.0

Weight complete 1500 lbs.; no B. B. 600 lbs.

- D.....\$172.00
- H.....162.00
- I.....159.00
- K.....155.00
- L.....151.00

M. M. finish. Carved on face only

No. 3724

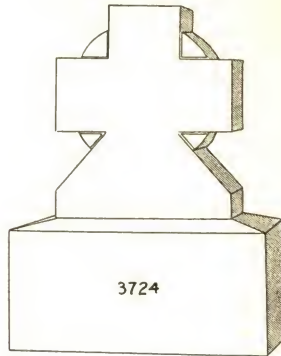

Cross.....1.2 x 0.4 x 2.6. .1.0
 B. Base.....1.6 x 0.8 x 0.8. .0.8

Weight complete 250 lbs.; no B. B. 130 lbs.

- C.....\$22.25
- D.....20.00
- F.....19.00
- G.....18.50
- H.....18.00
- I.....17.50
- K.....16.75
- L.....16.00

If B. B. is omitted deduct \$2.50
 Face only polished

No. 3724¹/₄

Cross.....1.0 x 0.4 x 2.0. .0.8
 B. Base.....1.4 x 0.8 x 0.8. .0.7

Weight complete 175 lbs.; no B. B. 70 lbs.

- C.....\$16.50
- D.....15.00
- F.....14.50
- G.....14.00
- H.....13.75
- I.....13.50
- K.....13.00
- L.....12.50

If B. B. is omitted deduct \$2.20
 Face only polished

No. 3724¹/₂

Cross.....0.10 x 0.4 x 1.2. .0.4
 B. Base.....1. 2 x 0.8 x 0.8. .0.6

Weight complete 125 lbs.; no B. B. 35 lbs.

- C.....\$11.00
- D.....10.25
- F.....10.00
- G.....9.75
- H.....9.50
- I.....9.25
- K.....9.00
- L.....8.75

If B. B. is omitted deduct \$1.90
 Face only polished

No. 3725

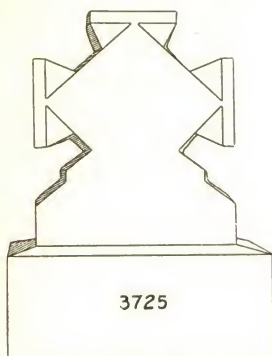

Cross.....1. 6 x 0. 6 x 2.6..1.11
 B. Base....1.10 x 0.10 x 0.8..1. 0
 Weight complete 500 lbs.; no B. B. 320 lbs.

- C.....\$35.75
- D.....31.50
- F.....29.50
- G.....28.50
- H.....27.50
- I.....26.75
- K.....25.25
- L.....23.75

If B. B. is omitted deduct \$3.75
 Face only polished

No. 3726

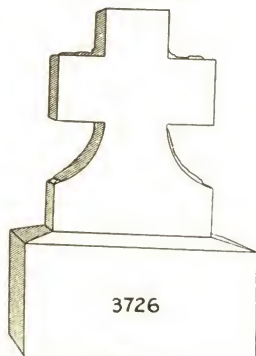

Cross.....1.2 x 0.4 x 2.6..1.0
 B. Base....1.6 x 0.8 x 0.8..0.8
 Weight complete 250 lbs.; no B. B. 130 lbs.

- C.....\$23.25
- D.....21.00
- F.....20.00
- G.....19.50
- H.....19.00
- I.....18.50
- K.....17.75
- L.....17.00

If B. B. is omitted deduct \$2.50
 Face only polished

No. 3725¹/₄

Cross.....1.4 x 0. 6 x 2.0..1. 4
 B. Base....1.8 x 0.10 x 0.8..0.11
 Weight complete 375 lbs.; no B. B. 210 lbs.

- C.....\$26.75
- D.....23.75
- F.....22.25
- G.....21.75
- H.....21.00
- I.....20.25
- K.....19.25
- L.....18.25

If B. B. is omitted deduct \$3.45
 Face only polished

No. 3726¹/₄

Cross.....1.0 x 0.4 x 2.0..0.8
 B. Base....1.4 x 0.8 x 0.8..0.7
 Weight complete 175 lbs.; no B. B. 70 lbs.

- C.....\$17.50
- D.....16.00
- F.....15.50
- G.....15.00
- H.....14.75
- I.....14.50
- K.....14.00
- L.....13.50

If B. B. is omitted deduct \$2.20
 Face only polished

No. 3725¹/₂

Cross.....1.2 x 0. 6 x 1.4..0. 9
 B. Base....1.6 x 0.10 x 0.8..0.10
 Weight complete 300 lbs.; no B. B. 150 lbs.

- C.....\$19.75
- D.....18.25
- F.....17.25
- G.....17.00
- H.....16.50
- I.....16.25
- K.....15.75
- L.....15.00

If B. B. is omitted deduct \$3.15
 Face only polished

No. 3726¹/₂

Cross.....0.10 x 0.4 x 1.2..0.4
 B. Base....1. 2 x 0.8 x 0.8..0.6
 Weight complete 125 lbs.; no B. B. 35 lbs.

- C.....\$11.75
- D.....11.00
- F.....10.75
- G.....10.50
- H.....10.25
- I.....10.00
- K.....9.75
- L.....9.50

If B. B. is omitted deduct \$1.90
 Face only polished

No. 3727

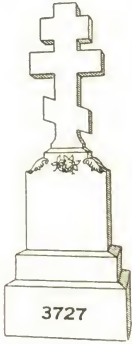

Cross.....1. 2 x 0.4 x 2. 4..0.11
 Die.....1. 6 x 0.8 x 1.10..1.10
 Base.....1.10 x 1.0 x 0. 6..0.11
 B. Base...2. 2 x 1.4 x 1. 0..2.11
 Weight complete 1075 lbs.; no B.B. 550 lbs.

C.....\$87.50
 D.....79.50
 F.....75.50
 G.....74.00
 H.....72.00
 I.....70.00
 K.....67.50
 L.....64.50

If B. B. is omitted deduct \$10.50
 Cut parts sand finished

No. 3727¹/₄

Cross.....1. 0 x 0. 3 x 2. 0..0.6
 Die.....1. 6 x 0. 6 x 1.10..1.5
 Base.....1.10 x 0.10 x 0. 6..0.9
 B. Base...2. 2 x 1. 2 x 0.10..2.1
 Weight complete 800 lbs.; no B. B. 425 lbs.

C.....\$66.00
 D.....60.00
 F.....57.00
 G.....56.00
 H.....54.50
 I.....53.00
 K.....51.00
 L.....49.25

If B. B. is omitted deduct \$7.50
 Cut parts sand finished

No. 3727¹/₂

Cross.....0.8 x 0.2 x 1. 4..0.2
 Die.....1.4 x 0.4 x 1. 8..0.9
 Base.....1.8 x 0.8 x 0. 5..0.6
 B. Base...2. 2.0 x 1.0 x 0.10..1.8
 Weight complete 525 lbs.; no B. B. 225 lbs.

C.....\$42.25
 D.....39.00
 F.....37.50
 G.....36.75
 H.....36.00
 I.....35.50
 K.....34.25
 L.....33.25

If B. B. is omitted deduct \$6.00
 Cut parts sand finished

No. 3728

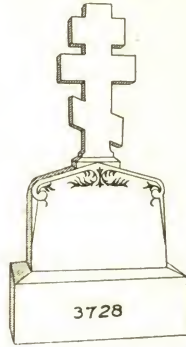

Cross.....1.2 x 0.4 x 2.4..0.11
 Die.....2.0 x 0.8 x 1.8..2. 3
 B. Base...2.6 x 1.2 x 1.0..2.11
 Weight complete 1000 lbs.; no B. B. 475 lbs.

C.....\$81.50
 D.....74.50
 F.....71.50
 G.....70.00
 H.....68.50
 I.....66.50
 K.....64.50
 L.....62.00

If B. B. is omitted deduct \$10.50
 Cut parts of cross sand finished; balance polished.

No. 3728¹/₄

Cross.....1. 0 x 0.3 x 2. 0..0. 6
 Die.....1.10 x 0.6 x 1. 6..1. 5
 B. Base...2. 4 x 1.0 x 0.10..1.11
 Weight complete 625 lbs.; no B. B. 280 lbs.

C.....\$54.50
 D.....50.00
 F.....48.25
 G.....47.25
 H.....46.25
 I.....45.50
 K.....44.00
 L.....42.50

If B. B. is omitted deduct \$6.90
 Cut parts of cross sand finished; balance polished.

No. 3728¹/₂

Cross.....0.8 x 0.2 x 1.4..0. 2
 Die.....1.8 x 0.4 x 1.4..0. 9
 B. Base...2.0 x 0.8 x 0.8..0.11
 Weight complete 300 lbs.; no B. B. 135 lbs.

C.....\$32.50
 D.....30.50
 F.....29.50
 G.....29.00
 H.....28.50
 I.....28.25
 K.....27.50
 L.....26.75

If B. B. is omitted deduct \$3.45
 Cut parts of cross sand finished; balance polished.

No. 3729

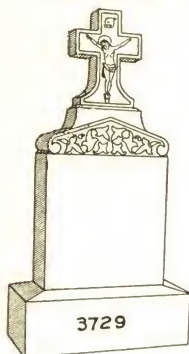

Cross.....1. 0 x 0.4 x 1.4 . 0.5
 Die.....1. 10 x 0.8 x 2.6 . 3.1
 B. Base.....2. 4 x 1.2 x 1.0 . 2.9
 Weight complete 1000 lbs.; no B. B. 505 lbs.

C.....\$83.00
 D.....75.00
 F.....72.00
 G.....70.00
 H.....68.50
 I.....66.50
 K.....64.00
 L.....61.25

If B. B. is omitted deduct \$9.90

No. 3729 $\frac{1}{4}$

Cross.....0.10 x 0.3 x 1. 2 . 0.3
 Die.....1. 6 x 0.6 x 2. 2 . 1.8
 B. Base.....2. 0 x 1.0 x 0.10 . 1.8
 Weight complete 600 lbs.; no B. B. 300 lbs.

C.....\$53.50
 D.....49.25
 F.....47.25
 G.....46.25
 H.....45.25
 I.....44.50
 K.....43.00
 L.....41.50

If B. B. is omitted deduct \$6.00

No. 3729 $\frac{1}{2}$

Cross.....0.10 x 0. 2 x 1. 2 . 0. 2
 Die.....1. 4 x 0. 4 x 2. 0 . 0.11
 B. Base.....1. 10 x 0.10 x 0.10 . 1. 3
 Weight complete 400 lbs.; no B. B. 175 lbs.

C.....\$37.75
 D.....35.25
 F.....34.25
 G.....33.75
 H.....33.00
 I.....32.50
 K.....31.75
 L.....31.00

If B. B. is omitted deduct \$4.50

No. 3732—A

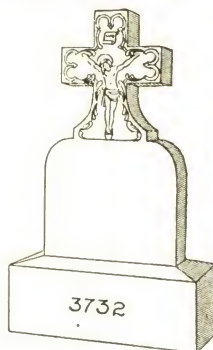

Cross.....1.6 x 0.6 x 3. 0 . 2.3
 B. Base.....2.0 x 1.0 x 0.10 . 1.8
 Weight complete 650 lbs.; no B. B. 350 lbs.

C.....\$53.00
 D.....48.25
 F.....45.75
 G.....44.75
 H.....43.50
 I.....42.50
 K.....40.75
 L.....39.00

If B. B. is omitted deduct \$6.00

Face only polished, back and edges sand finished; if back is polished \$1.75 extra; if back and edges are polished \$4.50 extra.

No. 3732

Cross.....1.6 x 0. 4 x 2. 6 . 1.3
 B. Base.....2.0 x 0.10 x 0.10 . 1.5
 Weight complete 450 lbs.; no B. B. 195 lbs.

C.....\$36.50
 D.....33.75
 F.....32.25
 G.....31.75
 H.....31.00
 I.....30.50
 K.....29.50
 L.....28.50

If B. B. is omitted deduct \$5.10

Face only polished, back and edges sand finished; if back is polished \$1.50 extra; if back and edges are polished \$3.50 extra.

No. 3732 $\frac{1}{4}$

Cross.....1.4 x 0.4 x 2. 4 . 1.0
 B. Base.....1.9 x 0.9 x 0.10 . 1.1
 Weight complete 350 lbs.; no B. B. 155 lbs.

C...\$30.50 H...\$26.25
 D... 28.25 I... 25.75
 F... 27.25 K... 25.00
 G... 26.75 L... 24.25

If B. B. is omitted deduct \$3.90

Face only polished, back and edges sand finished; if back is polished \$1.25 extra; if back and edges are polished \$3.00 extra.

No. 3737—A

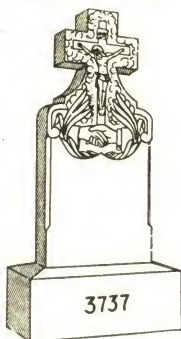

Cross.....1.6 x 0.6 x 3. 0..2.3
 B. Base.....2.0 x 1.0 x 0.10..1.8
 Weight complete 650 lbs.; no B. B. 350 lbs.

D.....	\$51.00
F.....	48.75
G.....	47.75
H.....	46.50
I.....	45.50
K.....	43.75
L.....	42.00

If B. B. is omitted deduct \$6.00
 Face only polished

No. 3737

Cross.....1.6 x 0. 4 x 3. 0..1.6
 B. Base.....2.0 x 0.10 x 0.10..1.5
 Weight complete 490 lbs.; no B. B. 235 lbs.

D.....	\$39.75
F.....	38.25
G.....	37.50
H.....	36.75
I.....	36.00
K.....	34.75
L.....	33.75

If B. B. is omitted deduct \$5.10
 Face only polished

No. 3737¹/₄

Cross.....1.4 x 0.4 x 3. 0..1.4
 B. Base.....1.9 x 0.9 x 0.10..1.1
 Weight complete 420 lbs.; no B. B. 225 lbs.

D.....	\$35.75
F.....	34.25
G.....	33.75
H.....	33.00
I.....	32.25
K.....	31.25
L.....	30.25

If B. B. is omitted deduct \$3.90
 Face only polished

No. 3739

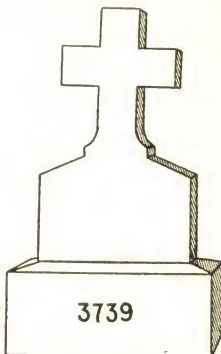

Cross.....1.4 x 0.4 x 2. 4..1.0
 B. Base.....1.9 x 0.9 x 0.10..1.1
 Weight complete 325 lbs.; no B. B. 130 lbs.

H.....	\$23.75
I.....	23.25
K.....	22.50
L.....	21.75

If B. B. is omitted deduct \$3.90
 Face only polished; back and edges
 sand finished. If back is polished \$1.25
 extra. If back and edges are polished
 \$3.00 extra.

No. 3739¹/₄

Cross.....1.0 x 0.4 x 2.0..0.8
 B. Base.....1.4 x 0.8 x 0.8..0.7
 Weight complete 200 lbs.; no B. B. 95 lbs.

H.....	\$16.50
I.....	16.25
K.....	15.75
L.....	15.25

If B. B. is omitted deduct \$2.19
 Face only polished; back and edges
 sand finished. If back is polished \$1.00
 extra. If back and edges are polished
 \$2.50 extra.

No. 3739¹/₂

Cross.....1.0 x 0.3 x 1.8..0.5
 B. Base.....1.4 x 0.7 x 0.6..0.5
 Weight complete 125 lbs.; no B. B. 50 lbs.

H.....	\$12.75
I.....	12.50
K.....	12.00
L.....	11.75

If B. B. is omitted deduct \$1.55
 Face only polished; back and edges
 sand finished. If back is polished 75c.
 extra. If back and edges are polished
 \$2.25 extra.

No. 3739³/₄

Cross.....0.10 x 0.2 x 1.8..0.3
 B. Base.....1. 2 x 0.6 x 0.6..0.4
 Weight complete 100 lbs.; no B. B. 40 lbs.

H.....	\$11.25
I.....	11.00
K.....	10.75
L.....	10.50

If B. B. is omitted deduct \$1.25
 Face only polished; back and edges
 sand finished. If back is polished 75c.
 extra. If back and edges are polished
 \$2.00 extra.

No. 3740

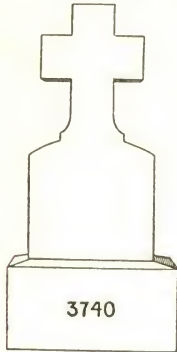

Sizes and prices same as No. 3739.

No. 3740¹/₄

Sizes and prices same as No. 3739¹/₄.

No. 3740¹/₂

Sizes and prices same as No. 3739¹/₂.

No. 3740³/₄

Sizes and prices same as No. 3739³/₄.

No. 3741

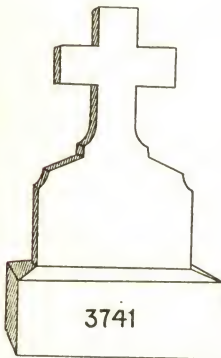

Sizes and prices same as No. 3739.

No. 3741¹/₄

Sizes and prices same as No. 3739¹/₄.

No. 3741¹/₂

Sizes and prices same as No. 3739¹/₂.

No. 3741³/₄

Sizes and prices same as No. 3739³/₄.

No. 3745

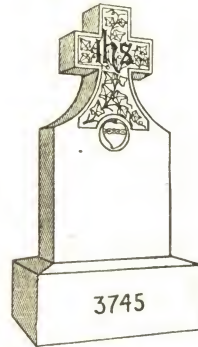

Cross.....1.6 x 0.6 x 3. 0..2.3
 B. Base.....2.0 x 1.0 x 0.10..1.8
 Weight complete 650 lbs.; no B. B. 350 lbs.

C.....	\$55.50
D.....	50.50
F.....	48.25
G.....	47.25
H.....	46.00
I.....	45.00
K.....	43.25
L.....	41.75

If B. B. is omitted deduct \$6.00
 Face only polished

No. 3745¹/₄

Cross.....1.6 x 0. 4 x 2.10..1.5
 B. Base.....2.0 x 0.10 x 0.10..1.5
 Weight complete 475 lbs.; no B. B. 220 lbs.

C.....	\$40.50
D.....	37.25
F.....	35.75
G.....	35.00
H.....	34.25
I.....	33.75
K.....	32.50
L.....	31.50

If B. B. is omitted deduct \$5.10
 Face only polished

No. 3745¹/₂

Cross.....1.4 x 0.4 x 2. 8..1.2
 B. Base.....1.9 x 0.9 x 0.10..1.1
 Weight complete 375 lbs.; no B. B. 180 lbs.

C.....	\$33.75
D.....	31.00
F.....	30.00
G.....	29.25
H.....	28.75
I.....	28.25
K.....	27.25
L.....	26.50

If B. B. is omitted deduct \$3.90
 Face only polished

No. 3747

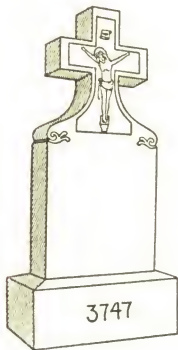

Cross.....1.8 x 0.6 x 3. 6. .2.11
 B. Base.....2.2 x 1.0 x 0.10. .1.10
 Weight complete 800 lbs.; no B. B. 470 lbs.

- C.....\$64.50
- D.....58.00
- F.....55.00
- G.....53.50
- H.....52.00
- I.....50.50
- K.....48.50
- L.....46.25

If B. B. is omitted deduct \$6.60
 Face only polished

No. 3747¹/₄

Cross.....1.6 x 0. 4 x 3. 0. .1.6
 B. Base.....2.0 x 0.10 x 0.10. .1.5
 Weight complete 500 lbs.; no B. B. 245 lbs.

- C.....\$42.00
- D.....38.50
- F.....37.00
- G.....36.25
- H.....35.50
- I.....34.75
- K.....33.50
- L.....32.50

If B. B. is omitted deduct \$5.10
 Face only polished

No. 3747¹/₂

Cross.....1.4 x 0.4 x 2. 6. .1.1
 B. Base.....1.9 x 0.9 x 0.10. .1.1
 Weight complete 350 lbs.; no B. B. 155 lbs.

- C.....\$32.50
- D.....30.00
- F.....29.00
- G.....28.50
- H.....27.75
- I.....27.25
- K.....26.50
- L.....25.75

If B. B. is omitted deduct \$3.90
 Face only polished

No. 3767

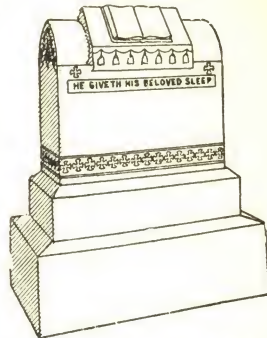

Die.....2.8 x 1.2 x 2.6. .7.9
 Base.....3.0 x 1.6 x 0.8. .3.0
 B. Base.....3.8 x 2.2 x 1.2. .9.3
 Weight complete 3500 lbs.; no B.B.1835 lbs.

- C.....\$198.00
- D.....173.00
- F.....163.00
- G.....157.00
- H.....152.00
- I.....147.00
- K.....138.00
- L.....130.00

If B. B. is omitted deduct \$32.40

No. 3767¹/₄

Die.....2. 6 x 1. 0 x 2.4. .5.10
 Base.....2.10 x 1. 4 x 0.8. .2. 6
 B. Base.....3. 4 x 1.10 x 1.2. .7. 2
 Weight complete 2700 lbs.; no B.B.1410 lbs.

- C.....\$157.00
- D.....138.00
- F.....130.00
- G.....126.00
- H.....122.00
- I.....117.00
- K.....111.00
- L.....105.00

If B. B. is omitted deduct \$25.10

No. 3767¹/₂

Die.....2.2 x 0.10 x 2.0. .3. 7
 Base.....2.6 x 1. 2 x 0.8. .1.11
 B. Base.....3.0 x 1. 8 x 1.0. .5. 0
 Weight complete 1800 lbs.; no B. B. 900 lbs.

- C.....\$107.00
- D.....94.50
- F.....89.00
- G.....86.00
- H.....83.50
- I.....80.50
- K.....76.50
- L.....72.50

If B. B. is omitted deduct \$17.50

No. 3767³/₄

Sizes and prices same as No. 3774¹/₂.

No. 3774

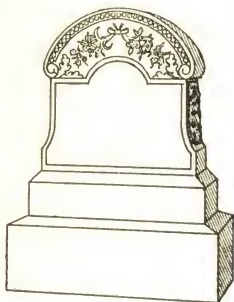

Die.....2. 6 x 1. 0 x 2.6. .6.3
 Base.....2.10 x 1. 4 x 0.8. .2.6
 B. Base....3. 4 x 1.10 x 1.2. .7.2
 Weight complete 2800 lbs.; no B.B.1510 lbs.

- C.....\$165.00
- D.....145.00
- F.....137.00
- G.....132.00
- H.....128.00
- I.....124.00
- K.....117.00
- L.....110.00

If B. B. is omitted deduct \$25.10

No. 3774¹/₄

Die.....2.4 x 0.10 x 2.4. .4.6
 Base.....2.8 x 1. 2 x 0.8. .2.1
 B. Base....3.2 x 1. 8 x 1.0. .5.3
 Weight complete 2000 lbs.; no B.B.1055 lbs.

- C.....\$129.00
- D.....114.00
- F.....108.00
- G.....104.00
- H.....101.00
- I.....98.00
- K.....93.00
- L.....88.00

If B. B. is omitted deduct \$18.40

No. 3774¹/₂

Die.....2.2 x 0.8 x 2.2. .3.2
 Base.....2.6 x 1.0 x 0.8. .1.8
 B. Base....3.0 x 1.6 x 1.0. .4.6
 Weight complete 1550 lbs.; no B. B. 740 lbs.

- C.....\$97.00
- D.....86.00
- F.....81.00
- G.....78.50
- H.....76.50
- I.....74.00
- K.....70.00
- L.....66.50

If B. B. is omitted deduct \$15.75

No. 3774³/₄

\$1.00 less than No. 3775³/₄.

No. 3775

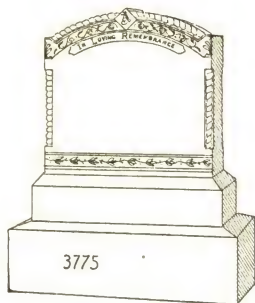

Die.....2. 6 x 1. 0 x 2.6. .6.3
 Base.....2.10 x 1. 4 x 0.8. .2.6
 B. Base....3. 4 x 1.10 x 1.2. .7.2
 Weight complete 2800 lbs.; no B.B.1510 lbs.

- C.....\$166.00
- D.....146.00
- F.....138.00
- G.....133.00
- H.....129.00
- I.....125.00
- K.....118.00
- L.....111.00

If B. B. is omitted deduct \$25.10

No. 3775¹/₄

\$1.50 more than No. 3774¹/₄.

No. 3775¹/₂

\$1.50 more than No. 3774¹/₂.

No. 3775³/₄

Die.....1.6 x 0.6 x 1. 6. .1.2
 Base.....1.9 x 0.9 x 0. 5. .0.7
 B. Base....2.2 x 1.2 x 0.10. .2.1
 Weight complete 675 lbs.; no B. B. 300 lbs.

- C.....\$43.75
- D.....40.00
- F.....38.00
- G.....37.25
- H.....36.25
- I.....35.50
- K.....34.25
- L.....32.75

If B. B. is omitted deduct \$7.50

No. 3783

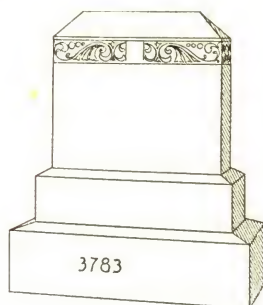

Die.....2. 6 x 1. 0 x 2.4..5.10
 Base.....2.10 x 1. 4 x 0.8..2. 6
 B. Base....3. 4 x 1.10 x 1.2..7. 2

Weight complete 2700 lbs.; no B. B. 1410 lbs.

C.....	\$153.00
D.....	134.00
F.....	126.00
G.....	122.00
H.....	118.00
I.....	113.00
K.....	107.00
L.....	101.00

If B. B. is omitted deduct \$25.10

No. 3783¹/₄

Die.....2.2 x 0.10 x 2.0..3. 7
 Base.....2.6 x 1. 2 x 0.8..1.11
 B. Base....3.0 x 1. 8 x 1.0..5. 0

Weight complete 1800 lbs.; no B. B. 900 lbs.

C.....	\$103.00
D.....	91.00
F.....	85.50
G.....	82.50
H.....	80.00
I.....	77.00
K.....	73.00
L.....	69.00

If B. B. is omitted deduct \$17.50

No. 3783¹/₂

See next column.

No. 3850



Spire.....0.9 x 0.9 x 4. 6..2.6
 Die.....1.2 x 1.2 x 1.10..2.6
 Base.....1.6 x 1.6 x 0. 8..1.6
 B. Base....2.0 x 2.0 x 1. 0..4.0

Weight complete 1700 lbs.; no B. B. 980 lbs.

C.....	\$134.00
D.....	119.00
F.....	113.00
G.....	110.00
H.....	106.00
I.....	103.00
K.....	98.00
L.....	93.50

If B. B. is omitted deduct \$14.00

No. 3783¹/₂

Die.....2.0 x 0.8 x 1.10..2. 5
 Base.....2.4 x 1.0 x 0. 8..1. 7
 B. Base....2.9 x 1.5 x 1. 0..3.11

Weight complete 1375 lbs.; no B. B. 670 lbs.

C.....	\$79.00
D.....	70.00
F.....	66.00
G.....	64.00
H.....	62.00
I.....	60.00
K.....	57.00
L.....	54.00

If B. B. is omitted deduct \$13.70

No. 3864

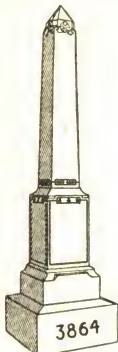

Spire.....1.0 x 1.0 x 6. 0. .6.0
 Die.....1.4 x 1.4 x 2. 0. .3.7
 Base.....1.8 x 1.8 x 0.10. .2.4
 B. Base.....2.2 x 2.2 x 1. 2. .5.6
 Weight complete 3000 lbs.; no B.B.2010 lbs.

C.....	\$207.00
D.....	180.00
F.....	168.00
G.....	162.00
H.....	156.00
I.....	150.00
K.....	141.00
L.....	132.00

If B. B. is omitted deduct \$19.25

No. 3864¹/₄

Spire.....0.10 x 0.10 x 5. 0. .3.6
 Die.....1. 2 x 1. 2 x 1.10. .2.6
 Base.....1. 6 x 1. 6 x 0. 8. .1.6
 B. Base.....2. 0 x 2. 0 x 1. 0. .4.0
 Weight complete 2000 lbs.; no B. B.1280 lbs.

C.....	\$139.00
D.....	122.00
F.....	114.00
G.....	111.00
H.....	107.00
I.....	103.00
K.....	97.50
L.....	92.00

If B. B. is omitted deduct \$14.00

No. 3864¹/₂

Spire.....0. 8 x 0. 8 x 4.0. .1.9
 Die.....1. 0 x 1. 0 x 1.8. .1.8
 Base.....1. 4 x 1. 4 x 0.8. .1.2
 B. Base.....1.10 x 1.10 x 1.0. .3.4
 Weight complete 1400 lbs.; no B. B.800 lbs.

C.....	\$92.50
D.....	82.50
F.....	77.50
G.....	75.50
H.....	73.00
I.....	71.00
K.....	67.50
L.....	64.00

If B. B. is omitted deduct \$11.65

No. 3909



Stump.....1. 2 x 1. 2 x 4.6. .6.2
 Base.....1.10 x 1.10 x 1.6. .5.1
 Weight complete 1700 lbs.

Blue.....	\$106.00
P. V. or Riv.....	95.00
White.....	86.00

If no emblem deduct \$5.00

No. 3909¹/₄

Stump.....1.2 x 1.2 x 4.0. .5.5
 Base.....1.8 x 1.8 x 1.4. .3.8
 Weight complete 1375 lbs.

Blue.....	\$85.00
P. V. or Riv.....	76.00
White.....	69.00

If no emblem deduct \$5.00

No. 3909¹/₂

Stump.....1.2 x 1.2 x 3.6. .4.9
 Base.....1.8 x 1.8 x 1.0. .2.9
 Weight complete 1100 lbs.

Blue.....	\$73.00
P. V. or Riv.....	66.00
White.....	60.00

If no emblem deduct \$5.00

No. 3909A

Stump.....1.2 x 1.2 x 3.6. .4.9
 B. Base.....1.8 x 1.8 x 1.0. .2.9
 Weight complete 1100 lbs.

Blue.....	\$57.00
P. V. or Riv.....	53.00
White.....	49.00

If no emblem deduct \$5.00
 Plain wash cut bottom base

No. 3911



Stump.....0.10 x 0.10 x 4. 0..2.9
 Die.....1. 2 x 1. 2 x 1.10..2.6
 B. Base...1. 6 x 1. 6 x 1. 0..2.3

Weight complete 1300 lbs.; no B. B. 895 lbs.

Rutland White,
 Riv., S. F., Blue
 or P. V.....\$62.50

If B. B. is omitted deduct \$8.10

No. 3916

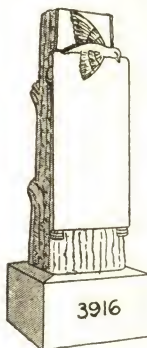

Stump.....1.2 x 1.2 x 3.6..4.9
 B. Base.....1.8 x 1.8 x 1.0..2.9

Weight complete 1100 lbs.; no B. B. 505 lbs.

Blue.....\$72.00
 P. V., S. F. or Riv... 67.00
 White..... 63.50

If B. B. is omitted deduct \$9.90

No. 3911¹/₄

Stump.....0.8 x 0.8 x 4. 0..1.9
 Die.....1.0 x 1.0 x 1. 8..1.8
 B. Base.....1.4 x 1.4 x 0.10..1.6

Weight complete 850 lbs.; no B. B. 580 lbs.

Rutland White,
 Riv., S. F., Blue
 or P. V.....\$43.25

If B. B. is omitted deduct \$5.40

No. 3916¹/₄

Stump.....1.0 x 1.0 x 3. 0..3. 0
 B. Base.....1.6 x 1.6 x 0.10..1.11

Weight complete 750 lbs.; no B. B. 405 lbs.

Blue.....\$56.50
 P. V., S. F. or Riv... 53.50
 White..... 51.00

If B. B. is omitted deduct \$6.90

No. 3911¹/₂

Stump....0. 6 x 0. 6 x 3. 6..0.11
 Die.....0.10 x 0.10 x 1. 4..0.11
 B. Base...1. 2 x 1. 2 x 0.10..1. 2

Weight complete 525 lbs.; no B. B. 315 lbs.

Rutland White,
 Riv., S. F., Blue
 or P. V.....\$28.75

If B. B. is omitted deduct \$4.20

No. 3916¹/₂

Stump....0.10 x 0.10 x 2.10..2.0
 B. Base...1. 4 x 1. 4 x 0.10..1.6

Weight complete 550 lbs.; no B. B. 280 lbs.

Blue.....\$43.00
 P. V., S. F. or Riv... 41.00
 White..... 39.50

If B. B. is omitted deduct \$5.40

No. 3918

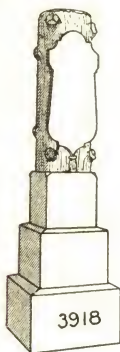

Stump.....1. 2 x 1. 2 x 4.6. .6.2
 Base.....1. 6 x 1. 6 x 1.0. .2.3
 B. Base....1. 10 x 1.10 x 1.4. .4.6

Weight complete 2100 lbs.; no B.B.1290 lbs.

Blue.....\$87.50
 P. V., S. F. or Riv... 79.00
 White..... 73.00

If B. B. is omitted deduct \$15.75

No. 3919

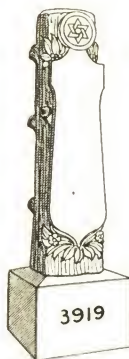

Stump.....1. 4 x 1. 4 x 5.0. .8.11
 B. Base....1. 10 x 1.10 x 1.4. .4. 6

Weight complete 2000 lbs.; no B.B.1190 lbs.

Blue.....\$91.00
 P. V., S. F. or Riv... 82.50
 White..... 75.50

If B. B. is omitted deduct \$15.75

No. 3919 $\frac{1}{4}$

Stump.....1.2 x 1.2 x 4.6. .6.2
 B. Base.....1.8 x 1.8 x 1.2. .3.3

Weight complete 1500 lbs.; no B. B. 915 lbs.

Blue.....\$68.50
 P. V., S. F. or Riv... 62.00
 White..... 57.50

If B. B. is omitted deduct \$11.40

No. 3918 $\frac{1}{4}$

Stump.....1.0 x 1.0 x 4.0. .4.0
 Base.....1.4 x 1.4 x 1.0. .1.9
 B. Base.....1.8 x 1.8 x 1.2. .3.3

Weight complete 1500 lbs.; no B.B.1290 lbs.

Blue.....\$66.00
 P. V., S. F. or Riv... 60.00
 White..... 56.00

If B. B. is omitted deduct \$11.40

No. 3919 $\frac{1}{2}$

Stump.....1.0 x 1.0 x 4.0. .4.0
 B. Base.....1.6 x 1.6 x 1.2. .2.8

Weight complete 1000 lbs.; no B. B. 520 lbs.

Blue.....\$50.50
 P. V., S. F. or Riv... 46.25
 White..... 43.25

If B. B. is omitted deduct \$9.60

No. 4004

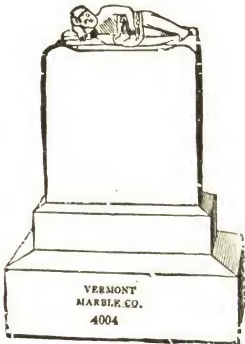

Die.....1.0 x 0.5 x 1.4 . . 0.7
 Base.....1.3 x 0.8 x 0.4 . . 0.3
 B. Base.....1.7 x 1.0 x 0.8 . . 1.1
 Weight complete 325 lbs.; no B. B. 130 lbs.

- C.....\$39.00
- D.....37.25
- F.....36.25
- G.....36.00
- H.....35.50
- I.....35.00
- K.....34.50
- L.....34.00

If B. B. is omitted deduct \$3.90

No. 4008

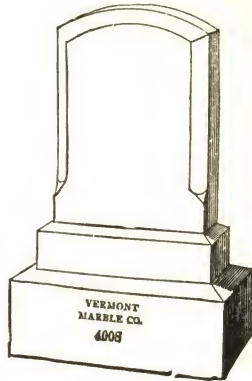

Die.....1.8 x 0.8 x 2.6 . . 2.9
 Base.....2.0 x 1.0 x 0.6 . . 1.0
 B. Base.....2.6 x 1.6 x 1.0 . . 3.9
 Weight complete 1300 lbs.; no B. B. 625 lbs.

- C.....\$75.00
- D.....66.50
- F.....62.50
- G.....61.00
- H.....59.00
- I.....57.00
- K.....54.00
- L.....51.50

If B. B. is omitted deduct \$13.15

No. 4004¹/₄

Die.....1.0 x 0.4 x 1.2 . . 0.5
 Base.....1.2 x 0.6 x 0.4 . . 0.2
 B. Base.....1.6 x 0.10 x 0.8 . . 0.10
 Weight complete 250 lbs.; no B. B. 100 lbs.

- C.....\$36.00
- D.....34.75
- F.....34.25
- G.....34.00
- H.....33.50
- I.....33.25
- K.....33.00
- L.....32.50

If B. B. is omitted deduct \$3.13

No. 4008¹/₄

Die.....1.6 x 0.6 x 2.0 . . 1.6
 Base.....1.9 x 0.9 x 0.5 . . 0.7
 B. Base.....2.2 x 1.2 x 0.10 . . 2.1
 Weight complete 700 lbs.; no B. B. 325 lbs.

- C.....\$44.50
- D.....39.75
- F.....37.75
- G.....36.75
- H.....35.50
- I.....34.50
- K.....33.00
- L.....31.50

If B. B. is omitted deduct \$7.50

No. 4012

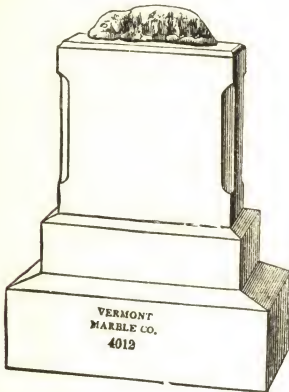

Die.....1.0 x 0.4 x 1.2..0.5
 Base.....1.2 x 0.6 x 0.4..0.2
 B. Base....1.6 x 0.10 x 0.8..0.10
 Weight complete 250 lbs.; no B. B. 100 lbs.

C.....	\$23.50
D.....	22.25
F.....	21.75
G.....	21.50
H.....	21.00
I.....	20.75
K.....	20.50
L.....	20.00

If B. B. is omitted deduct \$3.15

No. 4030

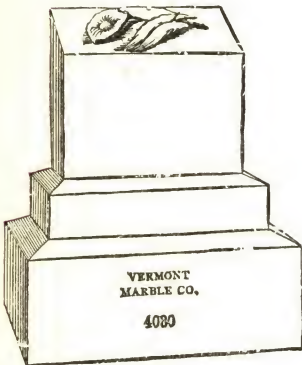

Die.....1.2 x 0.6 x 1.0..0.7
 Base.....1.5 x 0.9 x 0.4..0.4
 B. Base....1.9 x 1.1 x 0.10..1.7
 Weight complete 425 lbs.; no B. B. 140 lbs.

C...\$33.25	H...\$29.25
D... 31.25	I.... 29.00
F... 30.25	K.... 28.25
G... 29.75	L.... 27.50

If B. B. is omitted deduct \$5.70

No. 4042

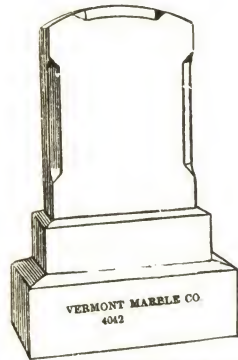

Die.....1.6 x 0.8 x 2.0..2.0
 Base.....1.10 x 1.0 x 0.6..0.11
 B. Base....2.3 x 1.5 x 1.0..3.2
 Weight complete 1050 lbs.; no B. B. 480 lbs.

C.....	\$59.50
D.....	53.00
F.....	50.00
G.....	48.50
H.....	47.00
I.....	45.75
K.....	43.50
L.....	41.25

If B. B. is omitted deduct \$11.10

No. 4042¹/₄

Die.....1.6 x 0.6 x 2.0..1.6
 Base.....1.9 x 0.9 x 0.5..0.7
 B. Base....2.2 x 1.2 x 0.10..2.1
 Weight complete 700 lbs.; no B. B. 325 lbs.

C.....	\$42.25
D.....	37.50
F.....	35.50
G.....	34.50
H.....	33.25
I.....	32.25
K.....	30.75
L.....	29.25

If B. B. is omitted deduct \$7.50

No. 4042¹/₂

Die.....1.6 x 0.4 x 2.0..1.0
 Base.....1.9 x 0.7 x 0.4..0.4
 B. Base....2.2 x 1.0 x 0.10..1.10
 Weight complete 525 lbs.; no B. B. 195 lbs.

C.....	\$30.25
D.....	27.25
F.....	25.75
G.....	25.25
H.....	24.50
I.....	23.75
K.....	22.75
L.....	21.75

If B. B. is omitted deduct \$6.60

No. 4040

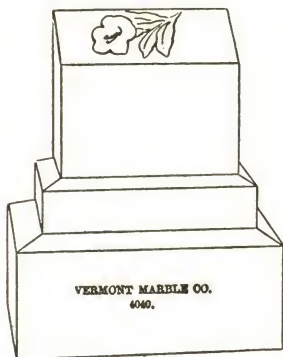

Die.....1.2 x 0.6 x 1.0..0.7
 Base.....1.5 x 0.9 x 0.6..0.6
 B. Base....1.9 x 1.1 x 0.10..1.7
 Weight complete 475 lbs.; no B. B. 190 lbs.
 C.....\$35.00
 D.....32.50
 F.....31.50
 G.....31.00
 H.....30.25
 I.....29.75
 K.....29.00
 L.....28.25
 If B. B. is omitted deduct \$5.70

No. 4043

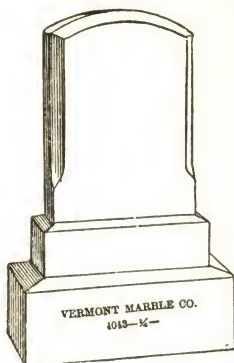

Die.....1.6 x 0.8 x 2.0..2.0
 Base.....1.10 x 1.0 x 0.6..0.11
 B. Base....2.3 x 1.5 x 1.0..3.2
 Weight complete 1050 lbs.; no B. B. 480 lbs.
 C.....\$59.50
 D.....53.00
 F.....50.00
 G.....48.50
 H.....47.00
 I.....45.75
 K.....43.50
 L.....41.25
 If B. B. is omitted deduct \$11.10

No. 4050



Die.....0.10 x 0.10 x 1.4..0.11
 B. Base....1.2 x 1.2 x 0.6..0.8
 Weight complete 250 lbs.; no B. B. 130 lbs.
 C.....\$38.25
 D.....36.25
 F.....35.25
 G.....34.75
 H.....34.25
 I.....34.00
 K.....33.25
 L.....32.50
 If B. B. is omitted deduct \$2.50

No. 4043 1/4

Die.....1.6 x 0.6 x 2.0..1.6
 Base.....1.9 x 0.9 x 0.5..0.7
 B. Base....2.2 x 1.2 x 0.10..2.1
 Weight complete 700 lbs.; no B. B. 325 lbs.
 C.....\$42.25
 D.....37.50
 F.....35.50
 G.....34.50
 H.....33.25
 I.....32.25
 K.....30.75
 L.....29.25
 If B. B. is omitted deduct \$7.50

No. 4043 1/2

Die.....1.6 x 0.4 x 2.0..1.0
 Base.....1.9 x 0.7 x 0.4..0.4
 B. Base....2.2 x 1.0 x 0.10..1.10
 Weight complete 525 lbs.; no B. B. 195 lbs.
 C.....\$30.25
 D.....27.25
 F.....25.75
 G.....25.25
 H.....24.50
 I.....23.75
 K.....22.75
 L.....21.75
 If B. B. is omitted deduct \$6.60

No. 4051

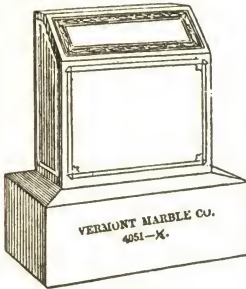

Die.....1.2 x 0.6 x 1.2...0.8
 B. Base.....1.6 x 0.10 x 0.8...0.10

Weight complete 250 lbs.; no B. B. 100 lbs.

C.....	\$18.25
D.....	16.75
F.....	16.25
G.....	15.75
H.....	15.50
I.....	15.25
K.....	14.75
L.....	14.25

If B. B. is omitted deduct \$3.15

No. 4083



Die.....1.4 x 1.4 x 1.10...3.3
 B. Base.....1.8 x 1.8 x 1.0...2.9

Weight complete 900 lbs.; no B. B. 405 lbs.

C.....	\$143.00
D.....	136.00
F.....	132.00
G.....	131.00
H.....	129.00
I.....	128.00
K.....	125.00
L.....	123.00

If B. B. is omitted deduct \$9.90

No. 4086

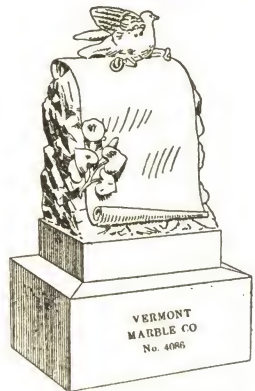

No. 4051¹/₄

Die.....1.0 x 0.6 x 1.0...0.6
 B. Base.....1.4 x 0.10 x 0.8...0.9

Weight complete 200 lbs.; no B. B. 65 lbs.

C.....	\$14.50
D.....	13.25
F.....	12.75
G.....	12.50
H.....	12.25
I.....	12.00
K.....	11.50
L.....	11.25

If B. B. is omitted deduct \$2.80

Die.....1.4 x 1.0 x 2.4...3.1
 B. Base.....1.8 x 1.4 x 0.10...1.10

Weight complete 800 lbs.; no B. B. 470 lbs.

C.....	\$127.00
D.....	121.00
F.....	117.00
G.....	116.00
H.....	114.00
I.....	113.00
K.....	111.00
L.....	108.00

If B. B. is omitted deduct \$6.60

No. 4094—A

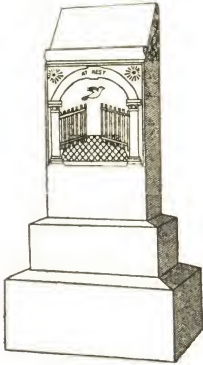

Die.....1. 2x0.8x2. 6. 1.11
 Base.....1. 6x1.0x0. 8. 1. 0
 B. Base... 1.10x1.4x0.10. .2. 0
 Weight complete 850 lbs.; no B. B. 490 lbs.

- C.....\$60.00
 - D..... 53.50
 - F..... 50.50
 - G..... 49.00
 - H..... 47.50
 - I..... 46.25
 - K..... 44.00
 - L..... 41.75
- If B. B. is omitted deduct \$7.20

No. 4094

Die.....1. 2x0.8x2. 0. 1.7
 Base.....1. 6x1.0x0. 8. 1.0
 B. Base... 1.10x1.4x0.10. .2. 0
 Weight complete 800 lbs.; no B. B. 440 lbs.

- C.....\$54.00
 - D..... 48.25
 - F..... 45.75
 - G..... 44.50
 - H..... 43.00
 - I..... 41.75
 - K..... 40.00
 - L..... 38.00
- If B. B. is omitted deduct \$7.20

No. 4094¹/₄

Die.....1.0x0. 6x2. 0. 1.0
 Base.....1.4x0.10x0. 6. .0.7
 B. Base... 1.8x1. 2x0.10. .1.7
 Weight complete 550 lbs.; no B. B. 265 lbs.

- C.....\$37.25
 - D..... 33.75
 - F..... 32.25
 - G..... 31.50
 - H..... 30.50
 - I..... 29.75
 - K..... 28.75
 - L..... 27.50
- If B. B. is omitted deduct \$5.70

No. 4095—A

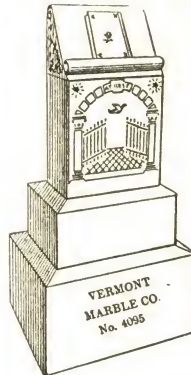

Die.....1. 2x0.8x2. 6. 1.11
 Base.....1. 6x1.0x0. 8. 1. 0
 B. Base... 1.10x1.4x0.10. .2. 0
 Weight complete 850 lbs.; no B. B. 490 lbs.

- C.....\$61.00
 - D..... 54.50
 - F..... 51.50
 - G..... 50.00
 - H..... 48.50
 - I..... 47.25
 - K..... 45.00
 - L..... 42.75
- If B. B. is omitted deduct \$7.20

No. 4095

Die.....1. 2x0.8x2. 0. 1.7
 Base.....1. 6x1.0x0. 8. 1.0
 B. Base... 1.10x1.4x0.10. .2. 0
 Weight complete 800 lbs.; no B. B. 440 lbs.

- C.....\$55.50
 - D..... 49.50
 - F..... 47.00
 - G..... 45.75
 - H..... 44.25
 - I..... 43.00
 - K..... 41.25
 - L..... 39.25
- If B. B. is omitted deduct \$7.20

No. 4095¹/₄

Die.....1.0x0. 6x2. 0. 1.0
 Base.....1.4x0.10x0. 6. .0.7
 B. Base... 1.8x1. 2x0.10. .1.7
 Weight complete 550 lbs.; no B. B. 265 lbs.

- C.....\$38.50
 - D..... 35.00
 - F..... 33.50
 - G..... 32.75
 - H..... 31.75
 - I..... 31.00
 - K..... 30.00
 - L..... 29.75
- If B. B. is omitted deduct \$5.70

No. 4096



Die.....1.0 x 0.4 x 1.0 .0.4
 B. Base.....1.4 x 0.8 x 0.8 .0.7
 Weight complete 160 lbs.; no B. B. 55 lbs.

- C.....\$11.25
 - D.....10.50
 - F.....10.25
 - G.....10.00
 - H.....9.75
 - I.....9.50
 - K.....9.25
 - L.....9.00
- If B. B. is omitted deduct \$2.00

No. 4097



Die.....1.0 x 0.4 x 1.0 .0.4
 B. Base.....1.4 x 0.8 x 0.8 .0.7
 Weight complete 160 lbs.; no B. B. 55 lbs.

- C.....\$11.25
 - D.....10.50
 - F.....10.25
 - G.....10.00
 - H.....9.75
 - I.....9.50
 - K.....9.25
 - L.....9.00
- If B. B. is omitted deduct \$2.20

No. 4098

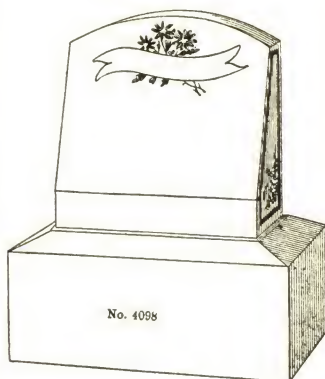

Die.....1.2 x 0.6 x 1.2 .0.8
 B. Base.....1.6 x 0.10 x 0.8 .0.10
 Weight complete 240 lbs.; no B. B. 90 lbs.

- C.....\$18.25
- D.....16.75
- F.....16.25
- G.....15.75
- H.....15.50
- I.....15.25
- K.....14.75
- L.....14.25

If B. B. is omitted deduct \$3.15

No. 4098 1/4

Die.....1.0 x 0.6 x 1.0 .0.6
 B. Base.....1.4 x 0.10 x 0.8 .0.9
 Weight complete 200 lbs.; no B. B. 65 lbs.

- C.....\$14.50
- D.....13.25
- F.....12.75
- G.....12.50
- H.....12.25
- I.....12.00
- K.....11.50
- L.....11.25

If B. B. is omitted deduct \$2.80

No. 4099

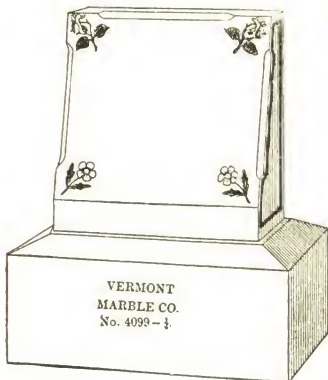

Die.....1.2 x 0.6 x 1.2 .0.8
 B. Base....1.6 x 0.10 x 0.8 .0.10

Weight complete 240 lbs.; no B. B. 90 lbs.

- C.....\$18.25
- D.....16.75
- F.....16.25
- G.....15.75
- H.....15.50
- I.....15.25
- K.....14.75
- L.....14.25

If B. B. is omitted deduct \$3.15

No. 4103

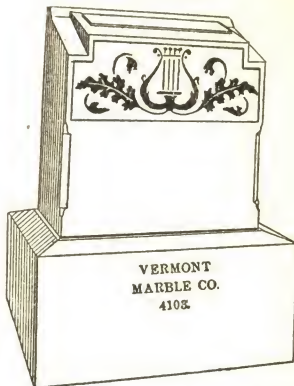

Die.....1.4 x 0.8 x 1.4 .1.2
 B. Base....1.8 x 1.0 x 0.10 .1.5

Weight complete 450 lbs.; no B. B. 195 lbs.

- C.....\$27.50
- D.....24.75
- F.....23.75
- G.....23.00
- H.....22.50
- I.....22.00
- K.....21.00
- L.....20.25

If B. B. is omitted deduct \$5.10

If polished entire add \$1.50

No. 4103¹/₄

Die.....1.4 x 0.6 x 1.4 .0.11

B. Base....1.8 x 0.10 x 0.10 .1.2

Weight complete 400 lbs.; no B. B. 190 lbs.

- C.....\$22.50
- D.....20.50
- F.....19.50
- G.....19.00
- H.....18.50
- I.....18.25
- K.....17.50
- L.....16.75

If B. B. is omitted deduct \$4.20

If polished entire add \$1.50

No. 4103¹/₂

Die.....1.2 x 0.6 x 1.2 .0.8

B. Base....1.6 x 0.10 x 0.8 .0.10

Weight complete 300 lbs.; no B. B. 150 lbs.

- C.....\$16.50
- D.....15.00
- F.....14.50
- G.....14.00
- H.....13.75
- I.....13.50
- K.....13.00
- L.....12.50

If B. B. is omitted deduct \$3.15

If polished entire add \$1.25

No. 4099¹/₄

Die.....1.0 x 0.6 x 1.0 .0.6

B. Base....1.4 x 0.10 x 0.8 .0.9

Weight complete 200 lbs.; no B. B. 65 lbs.

- C.....\$14.50
- D.....13.25
- F.....12.75
- G.....12.50
- H.....12.25
- I.....12.00
- K.....11.50
- L.....11.25

If B. B. is omitted deduct \$2.80

No. 4116

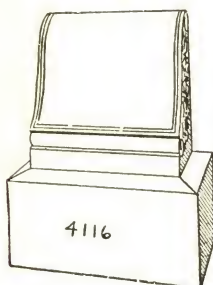

Die..... 1.8 x 0.10 x 1. 8. 2. 4
 B. Base.... 2.0 x 1. 2 x 0.10... 1.11

Weight complete 700 lbs.; no B. B. 355 lbs.

C.....	\$49.00
D.....	43.75
F.....	41.25
G.....	40.25
H.....	39.00
I.....	37.75
K.....	36.00
L.....	34.25

If B. B. is omitted deduct \$6.90

No. 4123

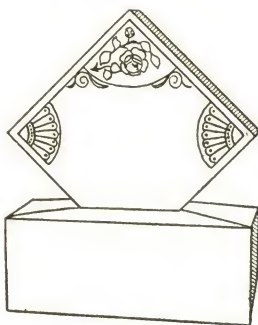

Die..... 1.0 x 0.4 x 1.0. .0.4
 B. Base..... 1.4 x 0.8 x 0.8. .0.7

Weight complete 160 lbs.

C.....	\$11.50
D.....	10.75
F.....	10.50
G.....	10.25
H.....	10.00
I.....	9.75
K.....	9.50
L.....	9.25

No. 4124

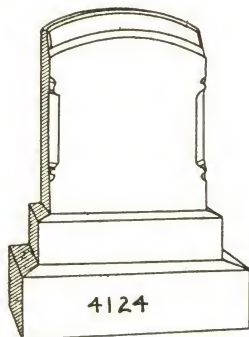

Die..... 1.6 x 0. 8 x 1.10. .1.10
 Base..... 1.9 x 0.11 x 0. 5. .0. 8
 B. Base.... 2.2 x 1. 4 x 0. 8. .1.11

Weight complete 750 lbs.; no B. B. 405 lbs.

C.....	\$27.50
D.....	24.75
F.....	23.75
G.....	23.00
H.....	22.50
I.....	22.00
K.....	21.00
L.....	20.25

If B. B. is omitted deduct \$5.10

C.....	\$48.00
D.....	42.25
F.....	39.75
G.....	38.50
H.....	37.25
I.....	36.00
K.....	34.00
L.....	32.25

If B. B. is omitted deduct \$6.90

No. 4116¹/₄

Die..... 1.4 x 0.8 x 1. 4. .1.2
 B. Base.... 1.8 x 1.0 x 0.10. .1.5

Weight complete 425 lbs.; no B. B. 170 lbs.

No. 4125

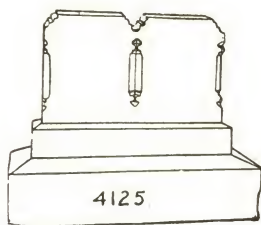

Die.....2.6 x 0.4 x 1. 6..1.3
 Base.....2.9 x 0.7 x 0. 5..0.8
 B. Base.....3.2 x 1.0 x 0.10..2.8
 Weight complete 800 lbs.; no B. B. 320 lbs.

C.....	\$46.50
D.....	42.25
F.....	40.25
G.....	39.25
H.....	38.25
I.....	37.50
K.....	36.00
L.....	34.50

If B. B. is omitted deduct \$9.60

No. 4126

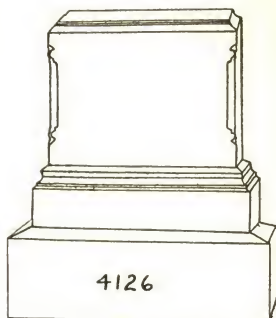

Die.....1.10 x 0.10 x 1. 6..2.4
 Base.....2. 1 x 1. 1 x 0. 6..1.2
 B. Base...2. 6 x 1. 6 x 0.10..3.2

Weight complete 1150 lbs.; no B. B. 580 lbs.

C.....	\$78.00
D.....	70.00
F.....	67.00
G.....	65.00
H.....	63.50
I.....	61.50
K.....	59.00
L.....	56.50

If B. B. is omitted deduct \$11.10

No. 4125¹/₄

Die.....2.0 x 0. 4 x 1.2..0.9
 Base.....2.2 x 0. 6 x 0.4..0.4
 B. Base....2.6 x 0.10 x 0.8..1.5

Weight complete 425 lbs.; no B. B. 170 lbs.

C.....	\$26.50
D.....	24.00
F.....	23.00
G.....	22.50
H.....	21.75
I.....	21.25
K.....	20.50
L.....	19.75

If B. B. is omitted deduct \$5.10

No. 4126¹/₄

Die.....1.10 x 0. 8 x 1. 6..1.10
 Base.....2. 1 x 0.11 x 0. 6..0.11
 B. Base...2. 6 x 1. 4 x 0.10..2. 9

Weight complete 950 lbs.; no B. B. 455 lbs.

C.....	\$64.00
D.....	58.00
F.....	55.00
G.....	54.00
H.....	52.50
I.....	51.00
K.....	49.00
L.....	47.00

If B. B. is omitted deduct \$9.90

No. 4127

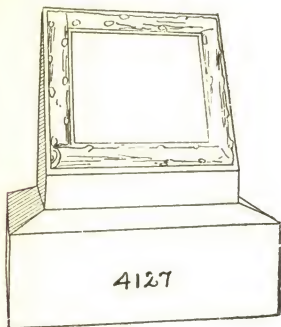

Die.....1.6 x 0.10 x 1.6...1.11
 B. Base....2.0 x 1.4 x 1.0...2.8
 Weight complete 750 lbs.; no B. B. 270 lbs.

C.....	\$44.00
D.....	39.75
F.....	37.75
G.....	36.75
H.....	35.75
I.....	35.00
K.....	33.50
L.....	32.00

If B. B. is omitted deduct \$9.60

No. 4127¹/₄

Die.....1.4 x 0.8 x 1.4...1.2
 B. Base....1.8 x 1.0 x 0.10...1.5
 Weight complete 425 lbs.; no B. B. 170 lbs.

C.....	\$27.50
D.....	24.75
F.....	23.75
G.....	23.00
H.....	22.50
I.....	22.00
K.....	21.00
L.....	20.25

If B. B. is omitted deduct \$5.10

No. 4135

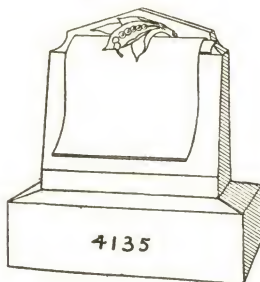

Die.....1.2 x 0.6 x 1.2...0.8
 B. Base....1.6 x 0.10 x 0.8...0.10
 Weight complete 240 lbs.; no B. B. 90 lbs.

C.....	\$28.50
D.....	27.00
F.....	26.50
G.....	26.00
H.....	25.75
I.....	25.50
K.....	25.00
L.....	24.50

If B. B. is omitted deduct \$3.15

No. 4141

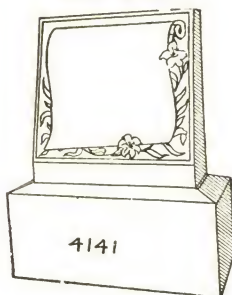

Die.....1.4 x 0.6 x 1.4...0.11
 B. Base....1.8 x 0.10 x 0.8...0.11
 Weight complete 325 lbs.; no B. B. 160 lbs.

G.....	\$16.50
H.....	16.00
I.....	15.75
K.....	15.00
L.....	14.25

If B. B. is omitted deduct \$3.45

No. 4141¹/₄

Die.....1.2 x 0.6 x 1.2...0.8
 B. Base....1.6 x 0.10 x 0.8...0.10
 Weight complete 240 lbs.; no B. B. 90 lbs.

G.....	\$14.00
H.....	13.75
I.....	13.50
K.....	13.00
L.....	12.50

If B. B. is omitted deduct \$3.15

No. 4142

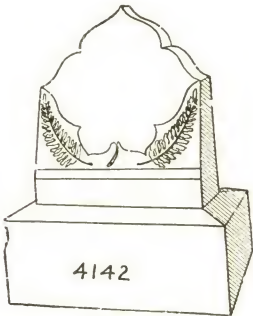

Die.....1.2 x 0.6 x 1.4..0.9
 B. Base.....1.6 x 0.10 x 0.8..0.10
 Weight complete 275 lbs.; no B. B. 125 lbs.

C.....	\$18.50
D.....	17.00
F.....	16.00
G.....	15.75
H.....	15.25
I.....	15.00
K.....	14.50
L.....	13.75

If B. B. is omitted deduct \$3.15

No. 4143

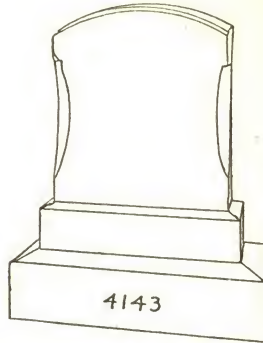

Die.....1.4 x 0.4 x 1.6..0.8
 Base.....1.6 x 0.6 x 0.4..0.3
 B. Base.....1.10 x 0.10 x 0.8..1.0
 Weight complete 340 lbs.; no B. B. 160 lbs.

C.....	\$22.00
D.....	20.00
F.....	19.00
G.....	18.50
H.....	18.00
I.....	17.75
K.....	17.00
L.....	16.25

If B. B. is omitted deduct \$3.75

No. 4152

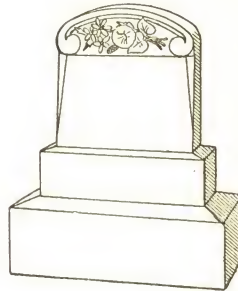

No. 4142 1/4
 Die.....1.0 x 0.6 x 1.2..0.7
 B. Base.....1.4 x 0.10 x 0.8..0.9
 Weight complete 225 lbs.; no B. B. 90 lbs.

C.....	\$14.50
D.....	13.25
F.....	12.75
G.....	12.50
H.....	12.00
I.....	11.75
K.....	11.50
L.....	11.00

If B. B. is omitted deduct \$2.80

Die.....1.0 x 0.4 x 1.0..0.4
 Base.....1.2 x 0.6 x 0.4..0.2
 B. Base.....1.6 x 0.10 x 0.8..0.10
 Weight complete 225 lbs.; no B. B. 75 lbs.

C.....	\$18.75
D.....	17.50
F.....	17.00
G.....	16.75
H.....	16.50
I.....	16.25
K.....	15.75
L.....	15.50

If B. B. is omitted deduct \$3.15

No. 4158

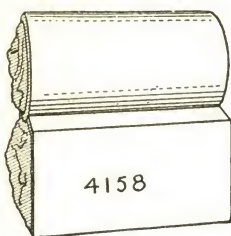

Die.....1.8 x 0.10 x 0.10..1.2
 Solid.....1.6 long
 B. Base....1.8 x 0.10 x 0.10..1.2
 Solid.....1.6 long

Weight complete 350 lbs.

C.....	\$26.25
D.....	23.50
F.....	22.50
G.....	21.75
H.....	21.25
I.....	20.75
K.....	19.75
L.....	19.00

No. 4158¹/₄

Die.....1.6 x 0.8 x 0.8..0.8
 Solid.....1.4 long
 B. Base....1.6 x 0.8 x 0.8..0.8
 Solid.....1.4 long

Weight complete 200 lbs.

C.....	\$17.25
D.....	15.75
F.....	15.25
G.....	14.75
H.....	14.50
I.....	14.25
K.....	13.75
L.....	13.25

No. 4165

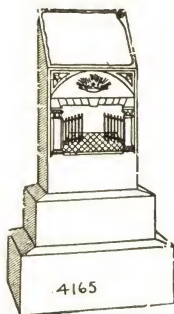

Die.....1.4 x 0.10 x 2.6..2.9
 Base.....1.8 x 1.2 x 0.8..1.4
 B. Base....2.0 x 1.6 x 1.0..3.0
 Weight complete 1175 lbs.; no B. B. 635 lbs.

C.....	\$74.00
D.....	64.50
F.....	60.50
G.....	58.50
H.....	56.50
I.....	54.50
K.....	51.50
L.....	48.00

If B. B. is omitted deduct \$10.80

No. 4165¹/₄

Die.....1.2 x 0.8 x 2.4..1.10
 Base.....1.6 x 1.0 x 0.8..1.0
 B. Base....1.10 x 1.4 x 0.10..2.0
 Weight complete 800 lbs.; no B. B. 440 lbs.

C.....	\$53.50
D.....	47.25
F.....	44.25
G.....	43.00
H.....	41.50
I.....	40.00
K.....	38.00
L.....	35.75

If B. B. is omitted deduct \$7.20

No. 4165¹/₂

Die.....1.0 x 0.6 x 2.0..1.0
 Base.....1.4 x 0.10 x 0.6..0.7
 B. Base....1.8 x 1.2 x 0.10..1.7
 Weight complete 525 lbs.; no B. B. 240 lbs.

C.....	\$33.75
D.....	30.25
F.....	28.75
G.....	28.00
H.....	27.00
I.....	26.25
K.....	25.00
L.....	24.00

If B. B. is omitted deduct \$5.70

No. 4166

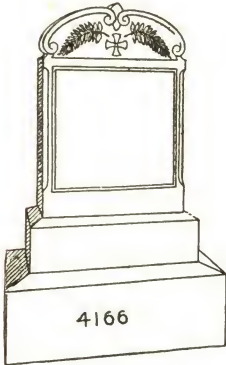

Die.....1.6 x 0.6 x 2.2..1.8
 Base.....1.9 x 0.9 x 0.5..0.7
 B. Base.....2.2 x 1.2 x 0.10..2.1

Weight complete 750 lbs.; no B. B. 375 lbs.

- C.....\$46.25
- D.....41.25
- F.....38.75
- G.....37.75
- H.....36.50
- I.....35.50
- K.....33.75
- L.....32.00

If B. B. is omitted deduct \$7.50

No. 4178

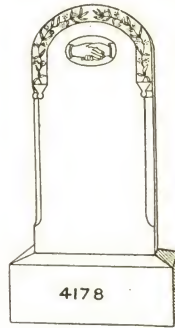

Die.....1.6 x 0.4 x 3.0..1.6
 B. Base.....2.0 x 1.0 x 0.10..1.8

Weight complete 550 lbs.; no B. B. 250 lbs.

- C.....\$32.50
- D.....29.00
- F.....27.50
- G.....26.75
- H.....26.00
- I.....25.25
- K.....24.00
- L.....23.00

If B. B. is omitted deduct \$6.00

No. 4166¹/₄

Die.....1.6 x 0.4 x 2.2..1.1
 Base.....1.9 x 0.7 x 0.4..0.4
 B. Base.....2.2 x 1.0 x 0.10..1.10

Weight complete 550 lbs.; no B. B. 220 lbs.

- C.....\$32.50
- D.....29.25
- F.....27.75
- G.....27.00
- H.....26.25
- I.....25.75
- K.....24.50
- L.....23.50

If B. B. is omitted deduct \$6.60

No. 4178¹/₄

Die.....1.4 x 0.3 x 2.8..0.11
 B. Base.....1.10 x 0.10 x 0.8..1.0

Weight complete 350 lbs.; no B. B. 170 lbs.

- C.....\$22.00
- D.....20.00
- F.....19.00
- G.....18.50
- H.....18.00
- I.....17.75
- K.....17.00
- L.....16.25

If B. B. is omitted deduct \$3.75

No. 4185

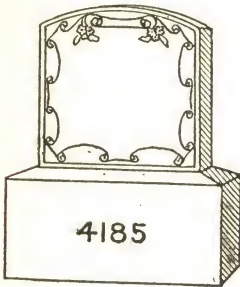

Die.....1.0 x 0.4 x 1.0..0.4
 B. Base.....1.4 x 0.8 x 0.8..0.7
 Weight complete 160 lbs.; no B. B. 55 lbs.

C.....	\$10.75
D.....	10.00
F.....	9.75
G.....	9.50
H.....	9.25
I.....	9.00
K.....	8.75
L.....	8.50

If B. B. is omitted deduct \$2.20

No. 4187

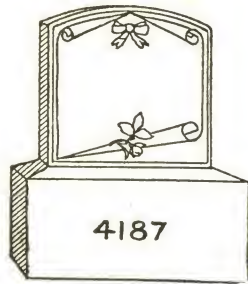

Die.....1.0 x 0.4 x 1.0..0.4
 B. Base.....1.4 x 0.8 x 0.8..0.7
 Weight complete 160 lbs.; no B. B. 55 lbs.

C.....	\$10.75
D.....	10.00
F.....	9.75
G.....	9.50
H.....	9.25
I.....	9.00
K.....	8.75
L.....	8.50

If B. B. is omitted deduct \$2.20

No. 4186

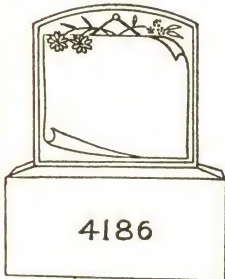

Die.....1.0 x 0.4 x 1.0..0.4
 B. Base.....1.4 x 0.8 x 0.8..0.7
 Weight complete 160 lbs.; no B. B. 55 lbs.

C.....	\$10.75
D.....	10.00
F.....	9.75
G.....	9.50
H.....	9.25
I.....	9.00
K.....	8.75
L.....	8.50

If B. B. is omitted deduct \$2.20

No. 4189



Die.....1.6 x 1.2 x 3.6..6.2
 B. Base.....1.10 x 1.6 x 0.4..0.11
 Weight complete 950 lbs.; no B. B. 785 lbs.

C.....	\$237.00
D.....	223.00
F.....	217.00
G.....	214.00
H.....	211.00
I.....	208.00
K.....	203.00
L.....	198.00

If B. B. is omitted deduct \$3.45

No. 4191

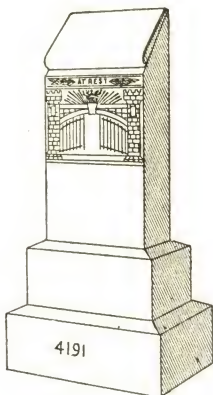

Die.....1.4 x 0.10 x 2.6..2.9
 Base.....1.8 x 1.2 x 0.8..1.4
 B. Base....2.0 x 1.6 x 1.0..3.0
 Weight complete 1200 lbs.; no B. B. 660 lbs.

C.....	\$76.00
D.....	67.00
F.....	63.00
G.....	61.00
H.....	59.00
I.....	57.00
K.....	54.00
L.....	51.00

If B. B. is omitted deduct \$10.80

No. 4191¹/₄

Die.....1.2 x 0.8 x 2.4..1.10
 Base.....1.6 x 1.0 x 0.8..1.0
 B. Base....1.10 x 1.4 x 0.10..2.0
 Weight complete 850 lbs.; no B. B. 490 lbs.

C.....	\$56.00
D.....	49.75
F.....	46.75
G.....	45.50
H.....	44.00
I.....	42.75
K.....	40.50
L.....	38.25

If B. B. is omitted deduct \$7.20

No. 4191¹/₂

Die.....1.0 x 0.6 x 2.0..1.0
 Base.....1.4 x 0.10 x 0.6..0.7
 B. Base....1.8 x 1.2 x 0.10..1.7
 Weight complete 550 lbs.; no B. B. 265 lbs.

C.....	\$34.75
D.....	31.25
F.....	29.75
G.....	29.00
H.....	28.00
I.....	27.25
K.....	26.25
L.....	25.00

If B. B. is omitted deduct \$5.70

No. 4196

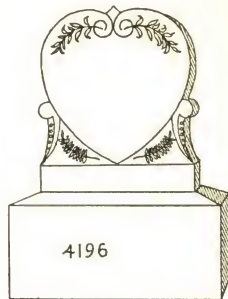

Die.....1.0 x 0.4 x 1.2..0.5
 B. Base....1.4 x 0.8 x 0.8..0.7
 Weight complete 180 lbs.; no B. B. 75 lbs.

C.....	\$14.00
D.....	13.00
F.....	12.75
G.....	12.50
H.....	12.25
I.....	12.00
K.....	11.50
L.....	11.25

If B. B. is omitted deduct \$2.20

No. 4196—A

Die.....1.2 x 0.4 x 1.6..0.7
 B. Base....1.6 x 0.8 x 0.8..0.8
 Weight complete 225 lbs.; no B. B. 105 lbs.

C.....	\$16.75
D.....	15.50
F.....	15.00
G.....	14.75
H.....	14.25
I.....	14.00
K.....	13.75
L.....	13.25

If B. B. is omitted deduct \$2.50

No. 4196—B

Die.....1.2 x 0.6 x 1.6..0.11
 B. Base....1.6 x 0.10 x 0.8..0.10
 Weight complete 300 lbs.; no B. B. 150 lbs.

C.....	\$22.00
D.....	20.00
F.....	19.00
G.....	18.50
H.....	18.00
I.....	17.75
K.....	17.00
L.....	16.25

If B. B. is omitted deduct \$3.15

No. 4197

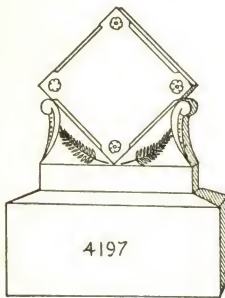

Die.....1.0 x 0.4 x 1.2 .0.5
 B. Base.....1.4 x 0.8 x 0.8 .0.7
 Weight complete 180 lbs.; no B. B. 75 lbs.

C.....	\$14.25
D.....	13.25
F.....	13.00
G.....	12.75
H.....	12.50
I.....	12.25
K.....	11.75
L.....	11.50

If B. B. is omitted deduct \$2.20

No. 4201

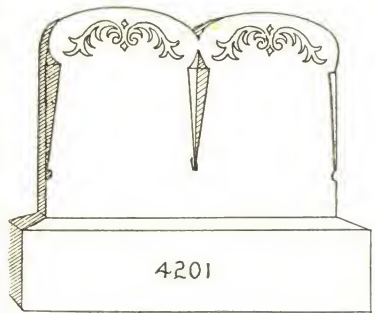

Die.....2.8 x 0.6 x 1.10 .2.5
 B. Base.....3.2 x 1.0 x 0.10 .2.8
 Weight complete 875 lbs.; no B. B. 395 lbs.

C.....	\$53.50
D.....	47.25
F.....	44.75
G.....	43.50
H.....	42.25
I.....	41.25
K.....	39.25
L.....	37.50

If B. B. is omitted deduct \$9.60

No. 4199

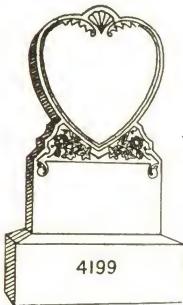

Die.....1.2 x 0.6 x 2.0 .1.2
 B. Base.....1.6 x 0.10 x 0.8 .0.10
 Weight complete 325 lbs.; no B. B. 175 lbs.

C.....	\$27.50
D.....	24.75
F.....	23.75
G.....	23.00
H.....	22.50
I.....	22.00
K.....	21.00
L.....	20.25

If B. B. is omitted deduct \$3.15

No. 4201 1/4

Die.....2.8 x 0.4 x 1.10 .1.8
 B. Base.....3.2 x 0.10 x 0.10 .2.2
 Weight complete 675 lbs.; no B. B. 285 lbs.

C.....	\$41.00
D.....	37.25
F.....	35.75
G.....	34.75
H.....	34.00
I.....	33.25
K.....	32.00
L.....	30.75

If B. B. is omitted deduct \$7.80

No. 4202

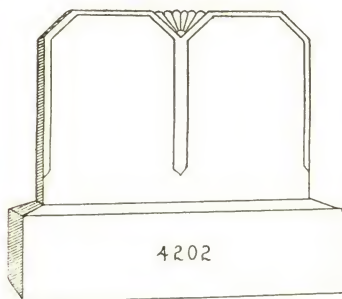

Die.....2.8 x 0.6 x 1.10..2.5
 B. Base.....3.2 x 1.0 x 0.10..2.8

Weight complete 875 lbs.; no B. B. 395 lbs.

C.....	\$49.00
D.....	43.50
F.....	41.00
G.....	39.75
H.....	38.50
I.....	37.50
K.....	35.50
L.....	33.75

If B. B. is omitted deduct \$9.60

No. 4203

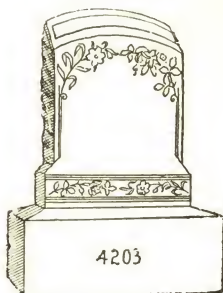

Die.....1.6 x 0.6 x 2.0..1.6
 B. Base.....2.0 x 1.0 x 0.10..1.8

Weight complete 525 lbs.; no B. B. 225 lbs.

C.....	\$36.00
D.....	32.50
F.....	31.00
G.....	30.25
H.....	29.50
I.....	28.75
K.....	27.50
L.....	26.50

If B. B. is omitted deduct \$6.00

3311

No. 4202 1/4

Die.....2.8 x 0.4 x 1.10..1.8
 B. Base.....3.2 x 0.10 x 0.10..2.2

Weight complete 675 lbs.; no B. B. 285 lbs.

C.....	\$37.50
D.....	33.75
F.....	32.25
G.....	31.25
H.....	30.50
I.....	29.75
K.....	28.50
L.....	27.25

If B. B. is omitted deduct \$7.50

No. 4203 1/4

Die.....1.4 x 0.6 x 1.8..1.1
 B. Base.....1.10 x 1.0 x 0.10..1.6

Weight complete 450 lbs.; no B. B. 180 lbs.

C.....	\$28.25
D.....	25.75
F.....	24.75
G.....	24.25
H.....	23.50
I.....	23.00
K.....	22.25
L.....	21.50

If B. B. is omitted deduct \$5.40

No. 4204

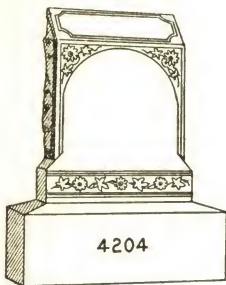

Die..... :...1.6 x 0.6 x 2. 0...1.6
 B. Base..... 2.0 x 1.0 x 0.10...1.8

Weight complete 525 lbs.; no B. B. 225 lbs.

C.....	\$36.00
D.....	32.50
F.....	31.00
G.....	30.25
H.....	29.50
I.....	28.75
K.....	27.50
L.....	26.50

If B. B. is omitted deduct \$6.00

No. 4204¹/₄

Die.....1. 4 x 0.6 x 1. 8...1.1
 B. Base..... 1.10 x 1.0 x 0.10...1.6

Weight complete 450 lbs.; no B. B. 180 lbs.

C.....	\$28.25
D.....	25.75
F.....	24.75
G.....	24.25
H.....	23.50
I.....	23.00
K.....	22.25
L.....	21.50

If B. B. is omitted deduct \$5.40

No. 4206

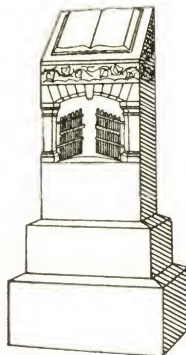

Die.....1.4 x 0.10 x 2.8...3.0

Base.....1.8 x 1.2 x 0.8...1.4

B. Base.....2.0 x 1.6 x 1.0...3.0

Weight complete 1250 lbs.; no B. B. 710 lbs.

C.....	\$85.00
D.....	75.00
F.....	71.00
G.....	68.50
H.....	66.50
I.....	64.50
K.....	61.00
L.....	58.00

If B. B. is omitted deduct \$10.35

No. 4206¹/₄

Die.....1. 2 x 0.8 x 2. 6...1.11

Base.....1. 6 x 1.0 x 0. 8...1. 0

B. Base..... 1.10 x 1.4 x 0.10...2. 0

Weight complete 850 lbs.; no B. B. 490 lbs.

C.....	\$61.00
D.....	54.50
F.....	51.50
G.....	50.00
H.....	48.50
I.....	47.25
K.....	45.00
L.....	42.75

If B. B. is omitted deduct \$7.20

No. 4206¹/₂

Die.....1.0 x 0. 6 x 2. 0...1.0

Base.....1.4 x 0.10 x 0. 6...0.7

B. Base..... 1.8 x 1. 2 x 0.10...1.7

Weight complete 550 lbs.; no B. B. 265 lbs.

C.....	\$38.75
D.....	35.25
F.....	33.75
G.....	33.00
H.....	32.00
I.....	31.25
K.....	30.25
L.....	29.00

If B. B. is omitted deduct \$5.70

No. 4207

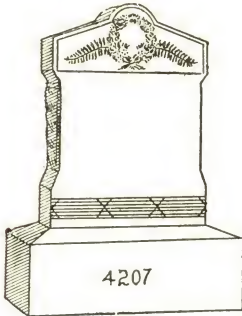

Die.....1.6 x 0.6 x 2. 0..1.6
 B. Base.....2.0 x 1.0 x 0.10..1.8

Weight complete 525 lbs.; no B. B. 225 lbs.

C.....	\$37.25
D.....	33.75
F.....	32.25
G.....	31.50
H.....	30.75
I.....	30.00
K.....	28.75
L.....	27.75

If B. B. is omitted deduct \$6.00

No. 4216



Die.....1.2 x 0.8 x 1.2..0.11
 B. Base.....1.6 x 1.0 x 0.8..1. 0

Weight complete 275 lbs.; no B. B. 100 lbs.

C.....	\$52.50
D.....	50.50
F.....	49.50
G.....	49.00
H.....	48.50
I.....	48.25
K.....	47.50
L.....	46.75

If B. B. is omitted deduct \$3.75

No. 4207¹/₄

Die.....1. 4 x 0.6 x 1. 8..1.1
 B. Base.....1.10 x 1.0 x 0.10..1.6

Weight complete 450 lbs.; no B. B. 180 lbs.

C.....	\$29.00
D.....	26.50
F.....	25.50
G.....	25.00
H.....	24.25
I.....	23.75
K.....	23.00
L.....	22.25

If B. B. is omitted deduct \$5.40

No. 4217¹/₄

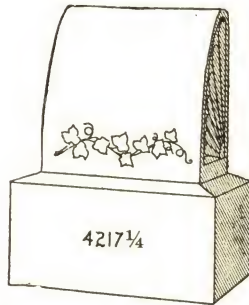

Die.....1.4 x 0.8 x 1. 4..1.2
 B. Base.....1.8 x 1.0 x 0.10..1.5

Weight complete 450 lbs.; no B. B. 200 lbs.

C.....	\$28.00
D.....	25.25
F.....	24.25
G.....	23.50
H.....	23.00
I.....	22.50
K.....	21.50
L.....	20.75

If B. B. is omitted deduct \$5.10

No. 4221

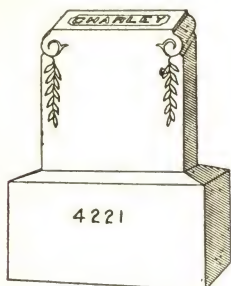

Die.....1.2 x 0.4 x 1.2..0.5
 B. Base.....1.6 x 0.8 x 0.8..0.8
 Weight complete 200 lbs.; no B. B. 80 lbs.

C.....	\$12.75
D.....	11.75
F.....	11.50
G.....	11.25
H.....	11.00
I.....	10.75
K.....	10.25
L.....	10.00

If B. B. is omitted deduct \$2.50

No. 4223

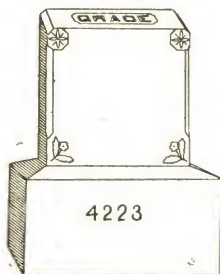

Die.....1.2 x 0.4 x 1.2..0.5
 B. Base.....1.6 x 0.8 x 0.8..0.8
 Weight complete 200 lbs.; no B. B. 80 lbs.

C.....	\$12.75
D.....	11.75
F.....	11.50
G.....	11.25
H.....	11.00
I.....	10.75
K.....	10.25
L.....	10.00

If B. B. is omitted deduct \$2.50

No. 4221 $\frac{1}{4}$

Die.....1.0 x 0.4 x 1.0..0.4
 B. Base.....1.4 x 0.8 x 0.8..0.7
 Weight complete 160 lbs.; no B. B. 55 lbs.

C.....	\$10.75
D.....	10.00
F.....	9.75
G.....	9.50
H.....	9.25
I.....	9.00
K.....	8.75
L.....	8.50

If B. B. is omitted deduct \$2.20

No. 4222

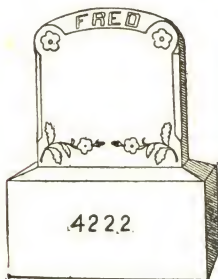

Sizes and prices same as No. 4221.

No. 4222 $\frac{1}{4}$

Sizes and prices same as No. 4221 $\frac{1}{4}$.

No. 4223 $\frac{1}{4}$

Die.....1.0 x 0.4 x 1.0..0.4
 B. Base.....1.4 x 0.8 x 0.8..0.7
 Weight complete 160 lbs.; no B. B. 55 lbs.

C.....	\$10.75
D.....	10.00
F.....	9.75
G.....	9.50
H.....	9.25
I.....	9.00
K.....	8.75
L.....	8.50

If B. B. is omitted deduct \$2.20

No. 4224

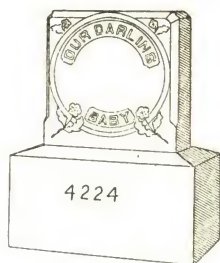

Die.....1.0 x 0.4 x 1.0 .0.4
 B. Base.....1.4 x 0.8 x 0.8 .0.7

Weight complete 160 lbs.; no B. B. 55 lbs.

C.....	\$11.00
D.....	10.25
F.....	10.00
G.....	9.75
H.....	9.50
I.....	9.00
K.....	8.75
L.....	8.50

If B. B. is omitted deduct \$2.20
 If traced lettering is omitted deduct 25c

No. 4230

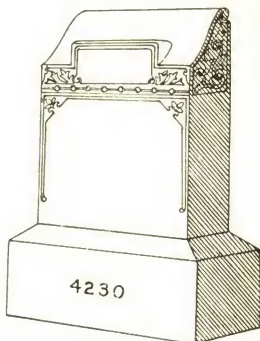

Die.....2.0 x 0.10 x 2.4 .3.11
 B. Base.....2.6 x 1.4 x 1.0 .3.4

Weight complete 1200 lbs.; no B. B. 600 lbs.

C.....	\$79.50
D.....	70.50
F.....	66.50
G.....	64.50
H.....	62.50
I.....	60.50
K.....	57.50
L.....	54.50

If B. B. is omitted deduct \$11.65

No. 4224¹/₄

Die.....0.10 x 0.4 x 0.10 .0.3
 B. Base.....1.2 x 0.8 x 0.6 .0.5

Weight complete 115 lbs.; no B. B. 40 lbs.

C.....	\$8.50
D.....	8.00
F.....	7.75
G.....	7.50
H.....	7.25
I.....	7.25
K.....	7.00
L.....	6.75

If B. B. is omitted deduct \$1.55
 If traced lettering is omitted deduct 25c

No. 4230¹/₄

Die.....1.8 x 0.8 x 2.0 .2.3
 B. Base.....2.0 x 1.0 x 0.10 .1.8

Weight complete 675 lbs.; no B. B. 365 lbs.

C.....	\$50.00
D.....	45.00
F.....	42.50
G.....	41.50
H.....	40.25
I.....	39.25
K.....	37.50
L.....	34.75

If B. B. is omitted deduct \$6.00

No. 4232

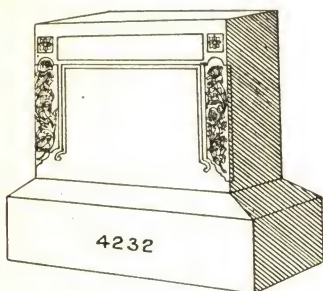

Die.....2. 4 x 0.10 x 2.4. .4. 6
 B. Base.....2.10 x 1. 4 x 1.0. .3. 9
 Weight complete 1475 lbs.; no B. B. 800 lbs.

- C.....\$82.50
- D.....72.25
- F.....67.75
- G.....65.50
- H.....63.25
- I.....61.00
- K.....56.50
- L.....54.50

If B. B. is omitted deduct \$13.15

No. 4232¹/₄

Die.....2.0 x 0.8 x 2.0. .2. 8
 B. Base.....2.6 x 1.2 x 1.0. .2. 11
 Weight complete 950 lbs.; no B. B. 425 lbs.

- C.....\$53.00
- D.....47.00
- F.....44.50
- G.....43.00
- H.....41.75
- I.....40.50
- K.....38.50
- L.....36.50

If B. B. is omitted deduct \$10.50

No. 4232¹/₂

Die.....1.6 x 0.6 x 1. 6. .1. 2
 B. Base.....2.0 x 1.0 x 0.10. .1. 8
 Weight complete 475 lbs.; no B. B. 175 lbs.

- C.....\$26.25
- D.....23.50
- F.....22.50
- G.....21.75
- H.....21.25
- I.....20.75
- K.....19.75
- L.....19.00

If B. B. is omitted deduct \$6.00

No. 4237

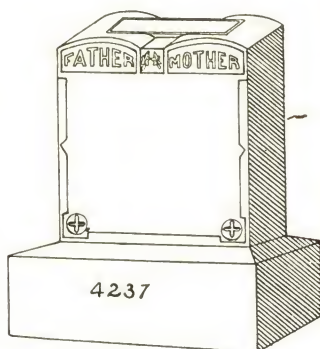

Die.....2.6 x 0.10 x 2.6. .5. 3
 B. Base.....3.0 x 1. 4 x 1.0. .4. 0
 Weight complete 1600 lbs.; no B. B. 860 lbs.

- C.....\$96.00
- D.....84.00
- F.....79.00
- G.....76.50
- H.....73.50
- I.....71.00
- K.....67.00
- L.....63.00

If B. B. is omitted deduct \$14.00

Price does not include lettering

No. 4237¹/₄

Die.....2. 4 x 0.8 x 2.4. .3. 8
 B. Base.....2.10 x 1.2 x 1.0. .3. 4
 Weight complete 1200 lbs.; no B. B. 600 lbs.

- C.....\$72.50
- D.....64.50
- F.....60.50
- G.....59.00
- H.....57.00
- I.....55.00
- K.....52.50
- L.....49.75

If B. B. is omitted deduct \$11.65

Price does not include lettering

No. 4237¹/₂

Die.....2.2 x 0.6 x 2. 2. .2. 4
 B. Base.....2.8 x 1.0 x 0.10. .2. 3
 Weight complete 775 lbs.; no B. B. 370 lbs.

- C.....\$49.75
- D.....44.50
- F.....42.00
- G.....41.00
- H.....39.75
- I.....38.50
- K.....36.75
- L.....35.00

If B. B. is omitted deduct \$8.10

Price does not include lettering

No. 4238

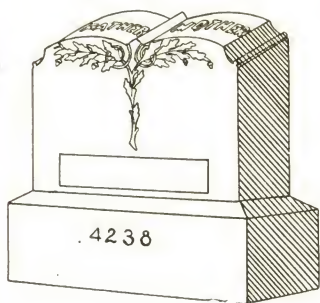

Die.....2.6 x 0.10 x 2.0 . . 4.2
 B. Base.....3.0 x 1.4 x 1.0 . . 4.0
 Weight complete 1400 lbs.; no B. B. 690 lbs.

- C.....\$83.50
- D.....74.00
- F.....70.00
- G.....68.00
- H.....66.00
- I.....63.50
- K.....60.50
- L.....57.50

If B. B. is omitted deduct \$14.00
 Price does not include lettering

No. 4238¹/₄

Die.....2.6 x 0.8 x 2.0 . . 3.4
 B. Base.....3.0 x 1.2 x 1.0 . . 3.6
 Weight complete 1150 lbs.; no B. B. 515 lbs.

- C.....\$69.50
- D.....62.00
- F.....59.00
- G.....57.00
- H.....55.50
- I.....54.00
- K.....51.50
- L.....49.00

If B. B. is omitted deduct \$12.25
 Price does not include lettering

No. 4238—A

Die.....2.8 x 0.6 x 2.0 . . 2.8
 B. Base.....3.2 x 1.0 x 0.10 . . 2.8
 Weight complete 925 lbs.; no B. B. 445 lbs.

- C.....\$58.00
- D.....52.00
- F.....49.25
- G.....47.75
- H.....46.50
- I.....45.25
- K.....43.25
- L.....41.25

If B. B. is omitted deduct \$9.60
 Price does not include lettering

No. 4240

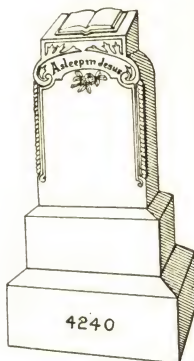

Die.....1.6 x 0.10 x 3.0 . . 3.9
 Base.....1.10 x 1.2 x 0.8 . . 1.5
 B. Base.....2.4 x 1.8 x 1.2 . . 4.6
 Weight complete 1650 lbs.; no B. B. 840 lbs.

- C.....\$107.00
- D.....95.50
- F.....90.50
- G.....88.00
- H.....85.50
- I.....82.50
- K.....79.00
- L.....75.00

If B. B. is omitted deduct \$15.75

No. 4240¹/₄

Die.....1.4 x 0.8 x 2.8 . . 2.4
 Base.....1.8 x 1.0 x 0.8 . . 1.1
 B. Base.....2.2 x 1.6 x 1.0 . . 3.3
 Weight complete 1150 lbs.; no B. B. 565 lbs.

- C.....\$75.50
- D.....67.50
- F.....64.50
- G.....62.50
- H.....61.00
- I.....59.00
- K.....56.50
- L.....54.00

If B. B. is omitted deduct \$11.40

No. 4244

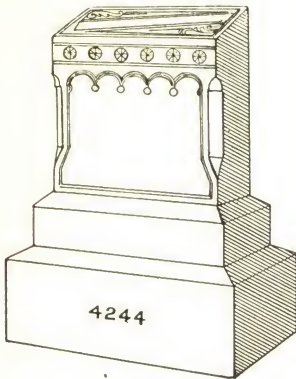

Die.....	2.4 x 0.10 x 2.4	4.6
Base.....	2.8 x 1.2 x 0.8	2.1
B. Base.....	3.2 x 1.8 x 1.0	5.3
Weight complete 2000 lbs.; no B. B. 1055 lbs.		
C.....		\$113.00
D.....		98.50
F.....		91.50
G.....		88.50
H.....		85.00
I.....		82.00
K.....		77.00
L.....		72.00
If B. B. is omitted deduct \$18.40		

No. 4244¹/₄

Die.....	2.0 x 0.8 x 2.0	2.8
Base.....	2.4 x 1.0 x 0.8	1.7
B. Base.....	2.10 x 1.6 x 1.0	4.3
Weight complete 1450 lbs.; no B. B. 685 lbs.		
C.....		\$81.00
D.....		71.50
F.....		67.50
G.....		65.50
H.....		63.00
I.....		61.00
K.....		58.00
L.....		54.50
If B. B. is omitted deduct \$14.90		

No. 4244¹/₂

Die.....	1.6 x 0.6 x 1.6	1.2
Base.....	1.9 x 0.9 x 0.5	0.7
B. Base.....	2.2 x 1.2 x 0.10	2.1
Weight complete 650 lbs.; no B. B. 275 lbs.		
C.....		\$38.75
D.....		35.00
F.....		33.00
G.....		32.25
H.....		31.25
I.....		30.50
K.....		29.25
L.....		27.75
If B. B. is omitted deduct \$7.50		

No. 4248

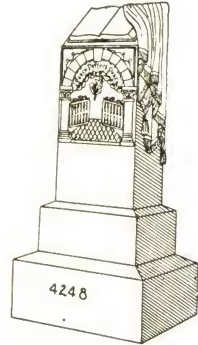

Die.....	1.5 x 0.10 x 3.0	3.7
Base.....	1.8 x 1.2 x 0.8	1.4
B. Base.....	2.0 x 1.6 x 1.0	3.0
Weight complete 1300 lbs.; no B. B. 760 lbs.		
C.....		\$107.00
D.....		96.00
F.....		91.00
G.....		88.50
H.....		86.00
I.....		83.50
K.....		80.00
L.....		76.50
If B. B. is omitted deduct \$10.80		

No. 4248¹/₄

Die.....	1.3 x 0.8 x 2.6	2.1
Base.....	1.6 x 1.0 x 0.8	1.0
B. Base.....	1.10 x 1.4 x 0.10	2.0
Weight complete 850 lbs.; no B. B. 490 lbs.		
C.....		\$74.50
D.....		67.50
F.....		64.50
G.....		63.00
H.....		61.50
I.....		60.00
K.....		57.50
L.....		55.00
If B. B. is omitted deduct \$7.20		

No. 4249

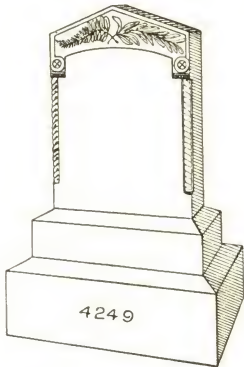

Die.....1.8 x 0. 6 x 2.6..2. 1
 Base.....2.0 x 0.10 x 0.6..0.10
 B. Base....2.5 x 1. 3 x 1.0..3. 0
 Weight complete 1000 lbs.; no B. B. 460 lbs.

C.....	\$66.00
D.....	59.50
F.....	56.50
G.....	55.00
H.....	53.50
I.....	52.00
K.....	50.00
L.....	47.75

If B. B. is omitted deduct \$10.80

No. 4249¹/₄

Die.....1.6 x 0.6 x 2. 2..1.8
 Base.....1.9 x 0.9 x 0. 5..0.7
 B. Base....2.2 x 1.2 x 0.10..2.1
 Weight complete 750 lbs.; no B. B. 375 lbs.

C.....	\$51.00
D.....	46.00
F.....	43.50
G.....	42.50
H.....	41.25
I.....	40.25
K.....	38.50
L.....	37.00

If B. B. is omitted deduct \$7.50

No. 4255

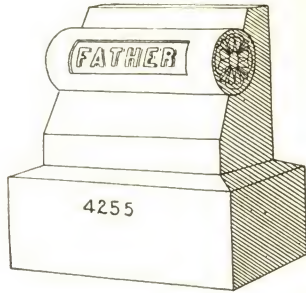

Die.....2.0 x 1.0 x 1.8..3.4
 B. Base.....2.5 x 1.5 x 1.0..3.5
 Weight complete 1150 lbs.; no B. B. 535 lbs.

C.....	\$74.00
D.....	66.50
F.....	63.50
G.....	61.50
H.....	60.00
I.....	58.50
K.....	56.00
L.....	53.50

If B. B. is omitted deduct \$11.95

No. 4255¹/₄

Die.....1.8 x 0.10 x 1. 4..1.10
 B. Base....2.0 x 1. 2 x 0.10..1.11
 Weight complete 650 lbs.; no B. B. 305 lbs.

C.....	\$46.25
D.....	42.25
F.....	40.25
G.....	39.50
H.....	38.50
I.....	37.50
K.....	36.25
L.....	34.75

If B. B. is omitted deduct \$6.90

No. 4255¹/₂

Die.....1.4 x 0.8 x 1. 2..1.0
 B. Base.....1.8 x 1.0 x 0.10..1.5
 Weight complete 375 lbs.; no B. B. 120 lbs.

C.....	\$31.00
D.....	28.75
F.....	27.75
G.....	27.25
H.....	26.75
I.....	26.25
K.....	25.50
L.....	24.75

If B. B. is omitted deduct \$5.10

No. 4258

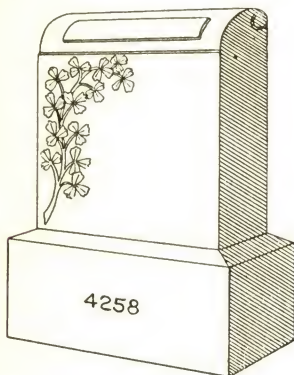

Die.....2.0 x 0.10 x 2.4 . . 3.11
 B. Base.....2.6 x 1.4 x 1.2 . . 3.11
 Weight complete 1350 lbs.; no B. B. 645 lbs.

C.....	\$79.00
D.....	70.00
F.....	66.00
G.....	64.00
H.....	62.00
I.....	60.00
K.....	57.00
L.....	54.50

If B. B. is omitted deduct \$13.70

No. 4258¹/₄

Die.....1.8 x 0.8 x 2.0 . . 2.3
 B. Base.....2.2 x 1.2 x 1.0 . . 2.6
 Weight complete 800 lbs.; no B. B. 350 lbs.

C.....	\$51.00
D.....	46.00
F.....	43.50
G.....	42.50
H.....	41.25
I.....	40.25
K.....	38.50
L.....	36.75

If B. B. is omitted deduct \$9.00

No. 4258¹/₂

Die.....1.6 x 0.6 x 1.10 . . 1.5
 B. Base.....1.10 x 0.10 x 0.10 . . 1.3
 Weight complete 450 lbs.; no B. B. 225 lbs.

C.....	\$32.25
D.....	29.00
F.....	27.50
G.....	26.75
H.....	26.00
I.....	25.50
K.....	24.25
L.....	23.25

If B. B. is omitted deduct \$4.50

No. 4259

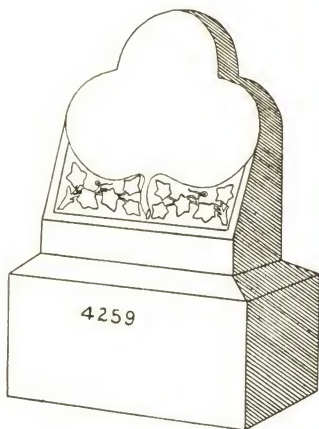

Die.....1.2 x 0.6 x 1.4 . . 0.9
 B. Base.....1.6 x 0.10 x 0.8 . . 0.10
 Weight complete 275 lbs.; no B. B. 125 lbs.

C.....	\$18.50
D.....	17.00
F.....	16.00
G.....	15.75
H.....	15.25
I.....	15.00
K.....	14.50
L.....	13.75

If B. B. is omitted deduct \$3.15

No. 4259¹/₄

Die.....1.0 x 0.6 x 1.2 . . 0.7
 B. Base.....1.4 x 0.10 x 0.8 . . 0.9
 Weight complete 225 lbs.; no B. B. 90 lbs.

C.....	\$14.50
D.....	13.25
F.....	12.75
G.....	12.50
H.....	12.00
I.....	11.75
K.....	11.50
L.....	11.00

If B. B. is omitted deduct \$2.80

No. 4263

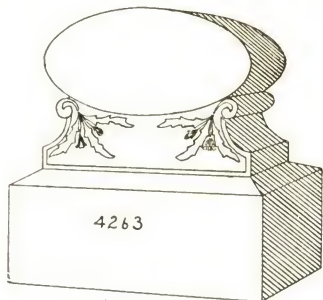

Die.....2. 4 x 0.10 x 1.10...3.7
 B. Base....2.10 x 1. 4 x 1. 0...3.9

Weight complete 1150 lbs.; no B. B. 475 lbs.

C.....	\$82.00
D.....	73.00
F.....	70.00
G.....	68.50
H.....	66.50
I.....	65.00
K.....	62.00
L.....	59.50

If B. B. is omitted deduct \$13.15

No. 4263¹/₄

Die.....2.2 x 0.8 x 1.8...2.5
 B. Base....2.8 x 1.2 x 1.0...3.1

Weight complete 850 lbs.; no B. B. 295 lbs.

C.....	\$60.00
D.....	54.00
F.....	52.00
G.....	50.50
H.....	49.25
I.....	48.00
K.....	46.25
L.....	44.50

1/4 B. B. is omitted deduct \$10.80

No. 4263¹/₂

Die.....2.0 x 0.6 x 1. 6...1.6
 B. Base....2.6 x 1.0 x 0.10...2.1

Weight complete 550 lbs.; no B. B. 175 lbs.

C.....	\$40.75
D.....	37.25
F.....	35.75
G.....	35.00
H.....	34.25
I.....	33.50
K.....	32.25
L.....	31.25

If B. B. is omitted deduct \$7.50

No. 4264

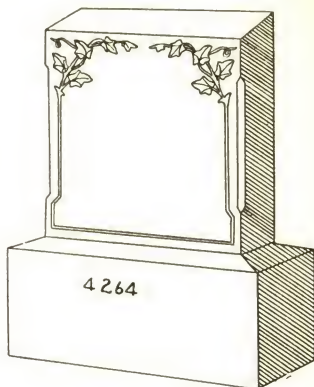

Die.....1.2 x 0.4 x 1.2...0.5
 B. Base....1.6 x 0.8 x 0.8...0.8

Weight complete 200 lbs.; no B. B. 80 lbs.

C.....	\$13.75
D.....	12.75
F.....	12.50
G.....	12.25
H.....	12.00
I.....	11.75
K.....	11.25
L.....	11.00

If B. B. is omitted deduct \$2.50

No. 4264¹/₄

Die.....1.0 x 0.4 x 1.0...0.4
 B. Base....1.4 x 0.8 x 0.8...0.7

Weight complete 160 lbs.; no B. B. 55 lbs.

C.....	\$11.25
D.....	10.50
F.....	10.25
G.....	10.00
H.....	9.75
I.....	9.50
K.....	9.25
L.....	9.00

If B. B. is omitted deduct \$2.20

No. 4265

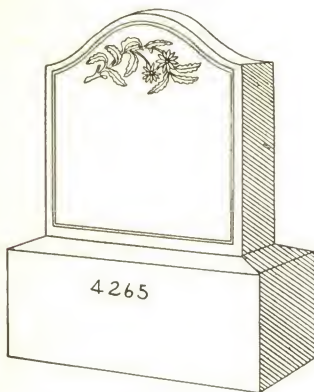

Die.....1.2 x 0.4 x 1.2...0.5
 B. Base.....1.6 x 0.8 x 0.8...0.8

Weight complete 200 lbs.; no B. B. 80 lbs.

C.....	\$13.75
D.....	12.75
F.....	12.50
G.....	12.25
H.....	12.00
I.....	11.75
K.....	11.25
L.....	11.00

If B. B. is omitted deduct \$2.50

No. 4265¹/₄

Die.....1.0 x 0.4 x 1.0...0.4
 B. Base.....1.4 x 0.8 x 0.8...0.7

Weight complete 160 lbs.; no B. B. 55 lbs.

C.....	\$11.25
D.....	10.50
F.....	10.25
G.....	10.00
H.....	9.75
I.....	9.50
K.....	9.25
L.....	9.00

If B. B. is omitted deduct \$2.20

No. 4267

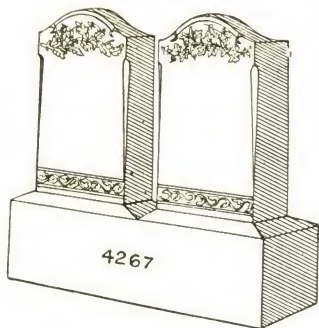

2 Dies.....1.6 x 0.6 x 2.6...3.10
 B. Base.....4.0 x 1.0 x 1.0...4.0

Weight complete 1350 lbs.; no B. B. 630 lbs.

C.....	\$84.50
D.....	76.00
F.....	72.00
G.....	70.00
H.....	68.50
I.....	66.50
K.....	63.50
L.....	60.50

If B. B. is omitted deduct \$14.00

No. 4267¹/₄

2 Dies.....1.6 x 0.4 x 2.4...2.4
 B. Base.....4.0 x 0.10 x 0.10...2.9

Weight complete 900 lbs.; no B. B. 400 lbs.

C.....	\$58.50
D.....	53.00
F.....	51.00
G.....	49.75
H.....	48.50
I.....	47.25
K.....	45.50
L.....	43.75

If B. B. is omitted deduct \$9.90

Either headstone may be ordered with bottom base at one-half of above prices. When so ordering, state whether "Oak" or "Ivy" tracing is wanted.

No. 4268

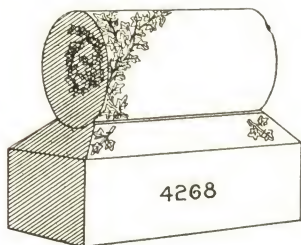

Roll.....1.10 x 1.0 x 1.0..1.10
 B. Base....2. 4 x 1.2 x 1.2..3. 2

Weight complete 750 lbs.

C.....	\$46.00
D.....	42.00
F.....	40.00
G.....	39.25
H.....	38.25
I.....	37.25
K.....	36.00
L.....	34.50

No. 4268¹/₄

Roll.....1.8 x 0.10 x 0.10..1.2
 B. Base....2.0 x 1.0 x 1.0..2.0

Weight complete 500 lbs.

C.....	\$31.25
D.....	28.50
F.....	27.50
G.....	26.75
H.....	26.25
I.....	25.75
K.....	24.75
L.....	24.00

No. 4268¹/₂

Roll.....1.6 x 0.8 x 0.8..0.8
 B. Base....1.10 x 0.10 x 0.10..1.3

Weight complete 275 lbs.

C.....	\$21.25
D.....	19.75
F.....	19.25
G.....	18.75
H.....	18.50
I.....	18.25
K.....	17.75
L.....	17.25

No. 4273

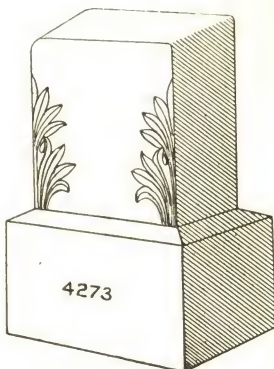

Die.....1.10 x 0.10 x 2.2..3.4
 B. Base....2. 2 x 1. 2 x 1.0..2.6

Weight complete 1050 lbs.; no B. B. 600 lbs.

C.....	\$62.00
D.....	54.50
F.....	51.50
G.....	49.75
H.....	48.00
I.....	46.25
K.....	43.75
L.....	41.25

If B. B. is omitted deduct \$9.00

No. 4273¹/₄

Die.....1.6 x 0.8 x 1.10..1.10
 B. Base....1.10 x 1.0 x 0.10..1.6

Weight complete 600 lbs.; no B. B. 330 lbs.

C.....	\$38.00
D.....	34.00
F.....	32.00
G.....	31.25
H.....	30.25
I.....	29.25
K.....	28.00
L.....	26.50

If B. B. is omitted deduct \$5.40

No. 4273¹/₂

Die.....1.2 x 0.6 x 1.4..0.9
 B. Base....1.6 x 0.10 x 0.8..0.10

Weight complete 275 lbs.; no B. B. 125 lbs.

C.....	\$19.00
D.....	17.50
F.....	16.50
G.....	16.25
H.....	15.75
I.....	15.50
K.....	15.00
L.....	14.25

If B. B. is omitted deduct 3.15

No. 4275

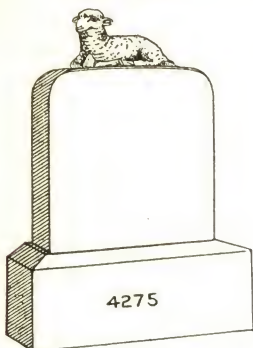

Die.....1.2 x 0.4 x 1.6..0.7
 B. Base.....1.6 x 0.8 x 0.8..0.8

Weight complete 200 lbs.; no B. B. 80 lbs.

- C.....\$25.25
- D.....24.00
- F.....23.50
- G.....23.25
- H.....22.75
- I.....22.50
- K.....22.25
- L.....21.75

If B. B. is omitted deduct \$2.50

No. 4279

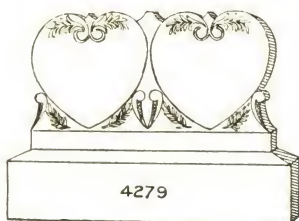

Die.....3.0 x 0.6 x 1.10..2.9
 B. Base.....3.6 x 1.0 x 0.10..2.11

Weight complete 950 lbs.; no B. B. 425 lbs.

- C.....\$66.50
- D.....60.50
- F.....57.50
- G.....56.50
- H.....55.00
- I.....53.50
- K.....51.50
- L.....49.25

If B. B. is omitted deduct \$10.50

No. 4279¹/₄

Die.....2.8 x 0.4 x 1.8..1.6
 B. Base.....3.2 x 0.10 x 0.10..2.2

Weight complete 600 lbs.; no B. B. 210 lbs.

- C.....\$44.25
- D.....40.75
- F.....39.25
- G.....38.50
- H.....37.75
- I.....37.00
- K.....35.75
- L.....34.75

If B. B. is omitted deduct \$7.80

No. 4275¹/₄

Die.....1.0 x 0.4 x 1.2..0.5
 B. Base.....1.4 x 0.8 x 0.8..0.7

Weight complete 175 lbs.; no B. B. 70 lbs.

- C.....\$21.50
- D.....20.50
- F.....20.25
- G.....20.00
- H.....19.75
- I.....19.50
- K.....19.00
- L.....18.75

If B. B. is omitted deduct \$2.20

No. 4279¹/₂

Die.....2.0 x 0.4 x 1.2..0.9
 B. Base.....2.4 x 0.8 x 0.8..1.0

Weight complete 300 lbs.; no B. B. 120 lbs.

- C.....\$28.00
- D.....26.50
- F.....25.50
- G.....25.25
- H.....24.75
- I.....24.50
- K.....24.00
- L.....23.25

If B. B. is omitted deduct \$3.75

No. 4281

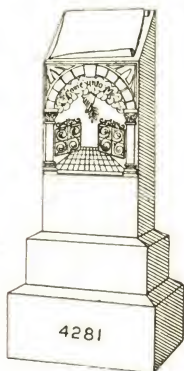

Die 1.4 x 0.10 x 3.0. .3.4
 Base..... 1.8 x 1. 2 x 0.8. .1.4
 B. Base..... 2.0 x 1. 6 x 1.0. .3.0
 Weight complete 1350 lbs.; no B. B. 810 lbs.
 C.....\$90.00
 D..... 79.50
 F..... 74.50
 G..... 72.50
 H..... 70.00
 I..... 67.50
 K..... 64.00
 L..... 60.50
 If B. B. is omitted deduct \$10.80

No. 4281¹/₄

Die.....1. 2 x 0.8 x 2. 6. .1.11
 Base.....1. 6 x 1.0 x 0. 8. .1. 0
 B. Base... 1.10 x 1.4 x 0.10. .2. 0
 Weight complete 850 lbs.; no B. B. 490 lbs.
 C.....\$61.00
 D..... 54.50
 F..... 51.50
 G..... 50.00
 H..... 48.50
 I..... 47.25
 K..... 45.00
 L..... 42.75
 If B. B. is omitted deduct \$7.20

No. 4281¹/₂

Die.....1.0 x 0. 6 x 2. 2. .1.1
 Base..... 1.4 x 0.10 x 0. 6. .0.7
 B. Base.... 1.8 x 1. 2 x 0.10. .1.7
 Weight complete 550 lbs.; no B. B. 265 lbs.
 C.....\$40.00
 D..... 36.25
 F..... 34.75
 G..... 33.75
 H..... 33.00
 I..... 32.25
 K..... 31.00
 L..... 29.75
 If B. B. is omitted deduct \$5.70

No. 4285

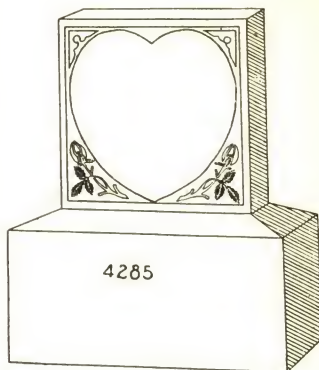

Die.....1.0 x 0.4 x 1.0. .0.4
 B. Base..... 1.4 x 0.8 x 0.8. .0.7
 Weight complete 160 lbs.; no B. B. 55 lbs.
 C.....\$9.50
 D..... 8.75
 F..... 8.50
 G..... 8.25
 H..... 8.00
 I..... 7.75
 K..... 7.50
 L..... 7.25
 If B. B. is omitted deduct \$2

No. 4285¹/₄

Die.....0.10 x 0.4 x 0.10. .0.3
 B. Base.... 1. 2 x 0.8 x 0. 8. .0.6
 Weight complete 135 lbs.; no B. B. 45 lbs.
 C.....\$7.00
 D..... 6.50
 F..... 6.25
 G..... 6.00
 H..... 6.00
 I..... 5.75
 K..... 5.50
 L..... 5.25
 If B. B. is omitted deduct \$1.90

No. 4288

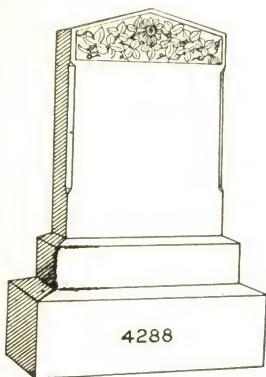

Die.....	1.8 x 0.6 x 2.6	.2. 1
Base.....	2.0 x 0.10 x 0.6	.0.10
B. Base....	2.5 x 1.3 x 1.0	.3. 0
Weight complete 1000 lbs.; no B. B. 460 lbs.		
C.....		\$65.00
D.....		58.50
F.....		55.50
G.....		54.00
H.....		52.50
I.....		51.00
K.....		49.00
L.....		46.75
If B. B. is omitted deduct \$10.80		

No. 4288¹/₄

Die.....	1.6 x 0.6 x 2.0	.1.6
Base.....	1.9 x 0.9 x 0.5	.0.7
B. Base....	2.2 x 1.2 x 0.10	.2. 1
Weight complete 700 lbs.; no B. B. 325 lbs.		
C.....		\$44.50
D.....		39.75
F.....		37.75
G.....		36.75
H.....		35.50
I.....		34.50
K.....		33.00
L.....		31.25
If B. B. is omitted deduct \$7.50		

No. 4288¹/₂

Die.....	1.6 x 0.4 x 2.0	.1. 0
Base.....	1.9 x 0.7 x 0.4	.0. 4
B. Base....	2.2 x 1.0 x 0.10	.1.10
Weight complete 550 lbs.; no B. B. 220 lbs.		
C.....		\$32.50
D.....		29.50
F.....		28.00
G.....		27.50
H.....		26.75
I.....		26.00
K.....		25.00
L.....		24.00
If B. B. is omitted deduct \$6.60		

No. 4289—A

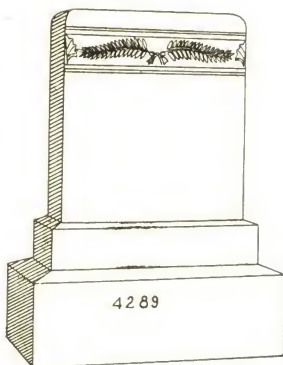

Die.....	1.6 x 0.6 x 2.0	.1.6
Base.....	1.9 x 0.9 x 0.5	.0.7
B. Base....	2.2 x 1.2 x 0.10	.2. 1
Weight complete 750 lbs.; no B. B. 375 lbs.		
C.....		\$44.50
D.....		39.75
F.....		37.75
G.....		36.75
H.....		35.50
I.....		34.50
K.....		33.00
L.....		31.50
If B. B. is omitted deduct \$7.50		

No. 4289

Die.....	1.6 x 0.6 x 1.8	.1.3
Base.....	1.8 x 0.8 x 0.4	.0.4
B. Base....	2.0 x 1.0 x 0.10	.1.8
Weight complete 575 lbs.; no B. B. 275 lbs.		
C.....		\$33.75
D.....		30.25
F.....		28.75
G.....		28.00
H.....		27.00
I.....		26.25
K.....		25.25
L.....		24.00
If B. B. is omitted deduct \$6.00		

No. 4289¹/₄

Die.....	1.4 x 0.4 x 1.6	.0.8
Base.....	1.6 x 0.6 x 0.4	.0.3
B. Base....	1.10 x 0.10 x 0.8	.1.0
Weight complete 325 lbs.; no B. B. 145 lbs.		
C.....		\$21.75
D.....		19.75
F.....		18.75
G.....		18.25
H.....		17.75
I.....		17.50
K.....		16.75
L.....		16.00
If B. B. is omitted deduct \$3.75		

No. 4290—A

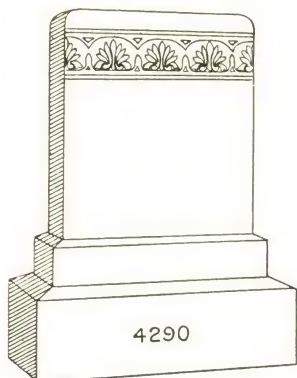

Die.....1.6 x 0.6 x 2. 0. 1.6
 Base.....1.9 x 0.9 x 0. 5. 0.7
 B. Base.....2.2 x 1.2 x 0.10. 2.1
 Weight complete 750 lbs.; no B. B. 375 lbs.
 C.....\$44.50
 D.....39.75
 F.....37.75
 G.....36.75
 H.....35.50
 I.....34.50
 K.....33.00
 L.....31.50
 If B. B. is omitted deduct \$7.50

No. 4290

Die.....1.6 x 0.6 x 1. 8. 1.3
 Base.....1.8 x 0.8 x 0. 4. 0.4
 B. Base.....2.0 x 1.0 x 0.10. 1.8
 Weight complete 575 lbs.; no B. B. 275 lbs.
 C.....\$33.75
 D.....30.25
 F.....28.75
 G.....28.00
 H.....27.00
 I.....26.25
 K.....25.25
 L.....24.00
 If B. B. is omitted deduct \$6.00

No. 4290¹/₄

Die.....1. 4 x 0. 4 x 1.6. 0.8
 Base.....1. 6 x 0. 6 x 0.4. 0.3
 B. Base.....1.10 x 0.10 x 0.8. 1.0
 Weight complete 325 lbs.; no B. B. 145 lbs.
 C.....\$21.75
 D.....19.75
 F.....18.75
 G.....18.25
 H.....17.75
 I.....17.50
 K.....16.75
 L.....16.00
 If B. B. is omitted deduct \$3.75

No. 4293

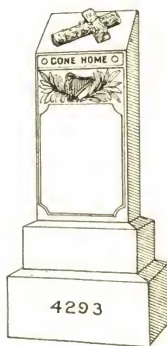

Die.....1.4 x 0.10 x 3.0. 3.4
 Base.....1.8 x 1. 2 x 0.8. 1.4
 B. Base.....2.0 x 1. 6 x 1.0. 3.0
 Weight complete 1300 lbs.; no B. B. 760 lbs.
 C.....\$93.50
 D.....83.00
 F.....78.00
 G.....76.00
 H.....73.50
 I.....71.00
 K.....67.50
 L.....64.00
 If B. B. is omitted deduct \$10.80

No. 4293¹/₄

Die.....1. 2 x 0.8 x 2. 6. 1.11
 Base.....1. 6 x 1.0 x 0. 8. 1. 0
 B. Base.....1.10 x 1.4 x 0.10. 2. 0
 Weight complete 850 lbs.; no B. B. 490 lbs.
 C.....\$64.50
 D.....58.00
 F.....55.00
 G.....53.50
 H.....52.00
 I.....50.50
 K.....48.50
 L.....46.25
 If B. B. is omitted deduct \$7.20

No. 4293¹/₂

Die.....1.0 x 0. 6 x 2. 2. 1.1
 Base.....1.4 x 0.10 x 0. 6. 0.7
 B. Base.....1.8 x 1. 2 x 0.10. 1.7
 Weight complete 550 lbs.; no B. B. 265 lbs.
 C.....\$40.75
 D.....37.00
 F.....35.50
 G.....34.50
 H.....33.75
 I.....33.00
 K.....31.75
 L.....30.50
 If B. B. is omitted deduct \$5.70

No. 4295

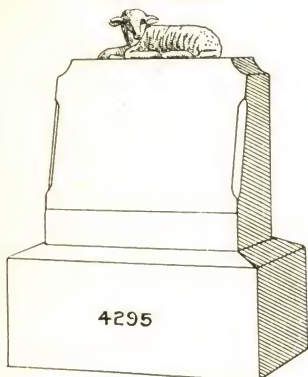

Die.....1.4 x 0.8 x 1. 6. 1.4
 B. Base.....1.8 x 1.0 x 0.10. 1.5
 Weight complete 475 lbs.; no B. B. 220 lbs.

C.....	\$40.50
D.....	37.50
F.....	36.00
G.....	35.50
H.....	34.75
I.....	34.00
K.....	33.00
L.....	32.00

If B. B. is omitted deduct \$5.10

No. 4298

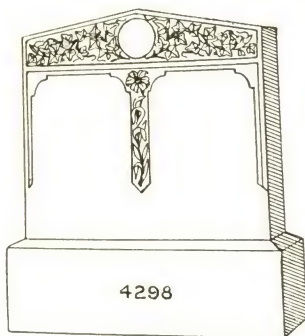

Die.....2.10 x 0.8 x 2.6. 4. 9
 B. Base.....3. 4 x 1.2 x 1.0. 3. 11
 Weight complete 1525 lbs.; no B. B. 820 lbs.

C.....	\$88.00
D.....	77.50
F.....	72.50
G.....	70.50
H.....	68.00
I.....	65.50
K.....	62.00
L.....	58.50

If B. B. is omitted deduct \$13.70

No. 4298¹/₄

Die.....2.8 x 0.6 x 2. 4. 3.1
 B. Base.....3.2 x 1.0 x 0.10. 2.8
 Weight complete 1000 lbs.; no B. B. 520 lbs.

C.....	\$60.00
D.....	53.00
F.....	50.00
G.....	48.50
H.....	46.75
I.....	45.25
K.....	43.00
L.....	40.75

If B. B. is omitted deduct \$9.60

No. 4295¹/₄

Die.....1.2 x 0. 6 x 1.4. 0. 9
 B. Base.....1.6 x 0.10 x 0.8. 0.10
 Weight complete 275 lbs.; no B. B. 125 lbs.

C.....	\$28.00
D.....	26.50
F.....	25.50
G.....	25.25
H.....	24.75
I.....	24.50
K.....	24.00
L.....	23.25

If B. B. is omitted deduct \$3.15

No. 4298¹/₂

Die.....2.6 x 0. 4 x 2. 2. 1.10
 B. Base.....3.0 x 0.10 x 0.10. 2. 1
 Weight complete 700 lbs.; no B. B. 325 lbs.

C.....	\$39.00
D.....	35.00
F.....	33.00
G.....	32.25
H.....	31.25
I.....	30.25
K.....	29.00
L.....	27.50

If B. B. is omitted deduct \$7.50

No. 4303

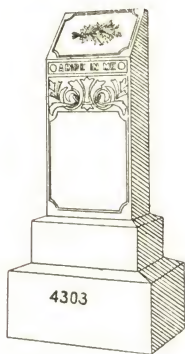

Die.....1.4 x 0.10 x 3.0..3.4
 Base.....1.8 x 1.2 x 0.8..1.4
 B. Base.....2.0 x 1.6 x 1.0..3.0
 Weight complete 1300 lbs.; no B. B. 760 lbs.

C.....\$84.00
 D.....73.50
 F.....68.50
 G.....66.50
 H.....64.00
 I.....61.50
 K.....58.00
 L.....54.50

If B. B. is omitted deduct \$10.80

No. 4303¹/₄

Die.....1.2 x 0.8 x 2.6..1.11
 Base.....1.6 x 1.0 x 0.8..1.0
 B. Base.....1.10 x 1.4 x 0.10..2.0
 Weight complete 850 lbs.; no B. B. 490 lbs.

C.....\$56.50
 D.....49.75
 F.....46.75
 G.....45.25
 H.....43.75
 I.....42.50
 K.....40.25
 L.....38.00

If B. B. is omitted deduct \$7.20

No. 4303¹/₂

Die.....1.0 x 0.6 x 2.2..1.1
 Base.....1.4 x 0.10 x 0.6..0.7
 B. Base.....1.8 x 1.2 x 0.10..1.7
 Weight complete 550 lbs.; no B. B. 265 lbs.

C.....\$36.25
 D.....32.50
 F.....31.00
 G.....30.00
 H.....29.25
 I.....28.50
 K.....27.25
 L.....26.00

If B. B. is omitted deduct \$5.70

No. 4306



Die.....2.0 x 0.10 x 2.6..4.2
 Base.....2.4 x 1.2 x 0.6..1.4
 B. Base.....2.10 x 1.8 x 1.0..4.9
 Weight complete 1700 lbs.; no B. B. 845 lbs.

C.....\$150.00
 D.....138.00
 F.....132.00
 G.....130.00
 H.....127.00
 I.....124.00
 K.....120.00
 L.....116.00

If B. B. is omitted deduct \$16.65

No. 4306¹/₄

Die.....1.10 x 0.8 x 2.2..2.8
 Base.....2.2 x 1.0 x 0.6..1.1
 B. Base.....2.8 x 1.6 x 0.10..3.4
 Weight complete 1200 lbs.; no B. B. 600 lbs.

C.....\$116.00
 D.....108.00
 F.....104.00
 G.....102.00
 H.....100.00
 I.....98.50
 K.....95.50
 L.....93.00

If B. B. is omitted deduct \$11.65

No. 4310

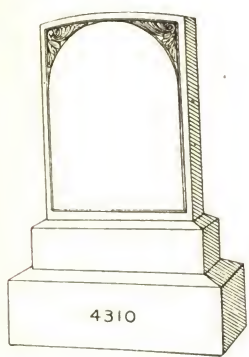

Die.....1.6 x 0.6 x 2. 0. .1.6
 Base.....1.9 x 0.9 x 0. 5. .0.7
 B. Base.....2.2 x 1.2 x 0.10. .2.1

Weight complete 700 lbs.; no B. B. 325 lbs.

C.....	\$47.00
D.....	42.25
F.....	40.25
G.....	39.25
H.....	38.00
I.....	37.00
K.....	35.50
L.....	34.00

If B. B. is omitted deduct \$7.50

No. 4311

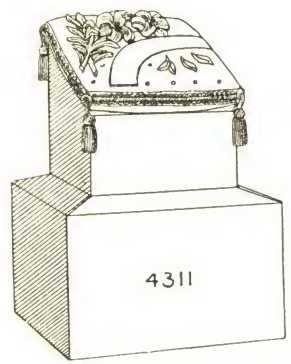

Die.....1.2 x 1.2 x 1.2. .1.7
 B. Base.....1.4 x 1.4 x 1.0. .1.9

Weight complete 575 lbs.; no B. B. 260 lbs.

C.....	\$77.00
D.....	73.50
F.....	71.50
G.....	71.00
H.....	70.00
I.....	69.50
K.....	68.00
L.....	67.00

If B. B. is omitted deduct \$6.30

No. 4310¹/₄

Die.....1.6 x 0.4 x 2. 0. .1. 0
 Base.....1.9 x 0.7 x 0. 4. .0. 4
 B. Base.....2.2 x 1.0 x 0.10. .1.10

Weight complete 525 lbs.; no B. B. 195 lbs.

C.....	\$35.50
D.....	32.50
F.....	31.00
G.....	30.50
H.....	29.75
I.....	29.00
K.....	28.00
L.....	27.00

If B. B. is omitted deduct \$6.60

No. 4311¹/₄

Die.....1.0 x 1.0 x 1. 0. .1. 0
 B. Base.....1.2 x 1.2 x 0.10. .1.2

Weight complete 375 lbs.; no B. B. 165 lbs.

C.....	\$60.00
D.....	57.50
F.....	56.50
G.....	56.00
H.....	55.50
I.....	55.00
K.....	54.50
L.....	53.50

If B. B. is omitted deduct \$4.20

No. 4317

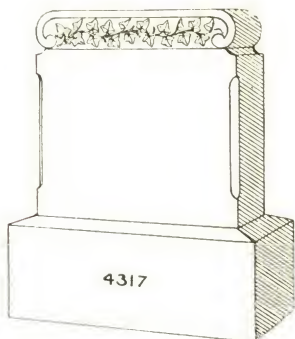

Die.....2.0 x 0.10 x 2.0 .3.4
 B. Base.....2.5 x 1.3 x 1.0 .3.0
 Weight complete 1100 lbs.; no B. B. 560 lbs.

- C.....\$62.00
- D.....54.50
- F.....51.50
- G.....49.75
- H.....48.00
- I.....46.25
- K.....43.75
- L.....41.25

If B. B. is omitted deduct \$10.80

No. 4317¹/₄

Die.....1.8 x 0.8 x 1.8 .1.10
 B. Base.....2.0 x 1.0 x 1.0 .2.0
 Weight complete 700 lbs.; no B. B. 340 lbs.

- C.....\$38.00
- D.....34.00
- F.....32.00
- G.....31.25
- H.....30.25
- I.....29.25
- K.....28.00
- L.....26.50

If B. B. is omitted deduct \$7.20

No. 4317¹/₂

Die.....1.6 x 0.6 x 1.6 .1.2
 B. Base.....1.10 x 0.10 x 0.10 .1.3
 Weight complete 425 lbs.; no B. B. 200 lbs.

- C.....\$25.50
- D.....22.75
- F.....21.75
- G.....21.00
- H.....20.50
- I.....20.00
- K.....19.00
- L.....18.25

If B. B. is omitted deduct \$4.50

No. 4325

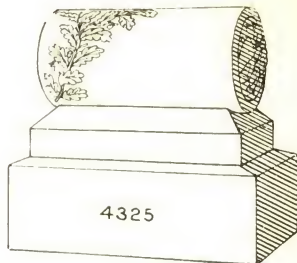

Roll.....2.2 x 1.0 x 1.0 .2.2
 Solid.....2.0 long
 Base.....2.2 x 1.0 x 0.6 .1.1
 B. Base.....2.6 x 1.4 x 1.0 .3.4
 Weight complete 1050 lbs.; no B. B. 450 lbs.

- C.....\$67.50
- D.....60.00
- F.....57.00
- G.....55.50
- H.....53.50
- I.....52.00
- K.....49.50
- L.....47.00

If B. B. is omitted deduct \$11.65

No. 4325¹/₄

Roll.....2.0 x 0.10 x 0.10 .1.5
 Solid.....1.10 long
 Base.....2.0 x 0.10 x 0.6 .0.10
 B. Base.....2.4 x 1.2 x 0.10 .2.3
 Weight complete 750 lbs.; no B. B. 345 lbs.

- C.....\$48.50
- D.....43.50
- F.....41.00
- G.....40.00
- H.....38.75
- I.....37.75
- K.....36.00
- L.....34.25

If B. B. is omitted deduct \$8.10

No. 4325¹/₂

Roll.....1.8 x 0.8 x 0.8 .0.9
 Solid.....1.6 long
 Base.....1.8 x 0.8 x 0.5 .0.6
 B. Base.....2.0 x 1.0 x 0.8 .1.4
 Weight complete 425 lbs.; no B. B. 185 lbs.

- C.....\$29.50
- D.....26.75
- F.....25.25
- G.....24.75
- H.....24.00
- I.....23.50
- K.....22.50
- L.....21.50

If B. B. is omitted deduct \$4.80

No. 4328

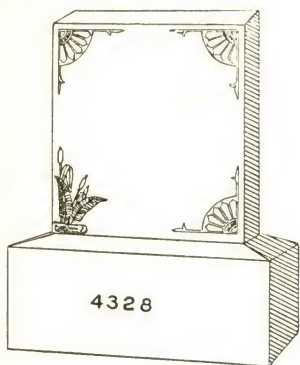

Die.....1.0 x 0.4 x 1.2..0.5
 B. Base.....1.4 x 0.8 x 0.8..0.7
 Weight complete 180 lbs.; no B. B. 75 lbs.
 C.....\$11.25
 D.....10.25
 F.....10.00
 G.....9.75
 H.....9.50
 I.....9.25
 K.....8.75
 L.....8.50
 If B. B. is omitted deduct \$2.20

No. 4329

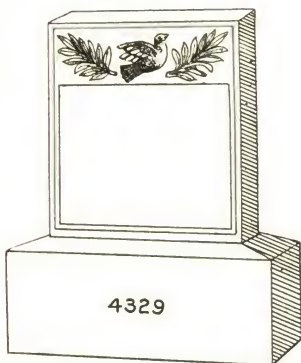

Die.....1.0 x 0.4 x 1.2..0.5
 B. Base.....1.4 x 0.8 x 0.8..0.7
 Weight complete 180 lbs.; no B. B. 75 lbs.
 C.....\$11.25
 D.....10.25
 F.....10.00
 G.....9.75
 H.....9.50
 I.....9.25
 K.....8.75
 L.....8.50
 If B. B. is omitted deduct \$2.20

No. 4332

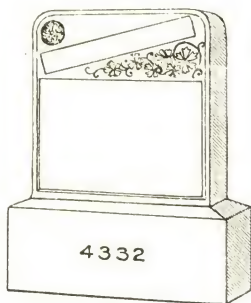

Die.....2. 4 x 0.10 x 2.4..4.6
 B. Base.....2.10 x 1. 4 x 1.2..4.5
 Weight complete 1595 lbs.; no B. B. 800 lbs.
 C.....\$85.50
 D.....75.50
 F.....71.00
 G.....68.50
 H.....66.50
 I.....62.00
 K.....60.50
 L.....57.50
 If B. B. is omitted deduct \$15.45

No. 4332¹/₄

Die.....1.10 x 0.8 x 2.0..2.5
 B. Base.....2. 4 x 1.2 x 1.2..3.2
 Weight complete 1000 lbs.; no B. B. 430 lbs.
 C.....\$52.50
 D.....47.00
 F.....44.50
 G.....43.25
 H.....42.00
 I.....41.00
 K.....39.00
 L.....37.25
 If B. B. is omitted deduct \$11.10

No. 4332¹/₂

Die.....1.4 x 0. 6 x 1. 4..0.11
 B. Base.....1.8 x 0.10 x 0.10..1. 2
 Weight complete 375 lbs.; no B. B. 165 lbs.
 C.....\$23.25
 D.....21.25
 F.....20.25
 G.....19.75
 H.....19.25
 I.....19.00
 K.....18.25
 L.....17.50
 If B. B. is omitted deduct \$4.20

No. 4335

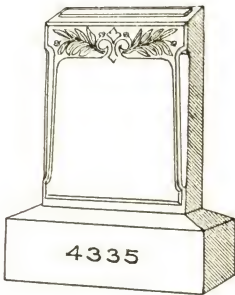

Die.....1.6 x 0.6 x 2. 0..1.6
 B. Base.....2.0 x 1.0 x 0.10..1.8
 Weight complete 550 lbs.; no B. B. 250 lbs.

C.....	\$33.75
D.....	30.25
F.....	28.75
G.....	28.00
H.....	27.25
I.....	26.50
K.....	25.25
L.....	24.25

If B. B. is omitted deduct \$6.00

No. 4337

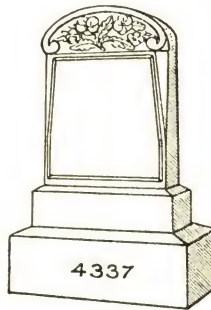

Die.....1.6 x 0.6 x 2. 0..1.6
 Base.....1.9 x 0.9 x 0. 5..0.7
 B. Base.....2.2 x 1.2 x 0.10..2.1
 Weight complete 700 lbs.; no B. B. 325 lbs.

C.....	\$50.50
D.....	45.75
F.....	43.75
G.....	42.75
H.....	41.50
I.....	40.50
K.....	39.00
L.....	37.50

If B. B. is omitted deduct \$7.50

No. 4335¹/₄

Die.....1.6 x 0. 4 x 2. 0..1.0
 B. Base....2.0 x 0.10 x 0.10 .1 5
 Weight complete 425 lbs.; no B. B. 170 lbs.

C.....	\$26.00
D.....	23.75
F.....	22.75
G.....	22.25
H.....	21.75
I.....	21.25
K.....	20.50
L.....	19.75

If B. B. is omitted deduct \$5.10

No. 4337¹/₄

Die.....1.6 x 0.4 x 2. 0..1. 0
 Base.....1.9 x 0.7 x 0. 4..0. 4
 B. Base....2.2 x 1.0 x 0.10..1.10
 Weight complete 525 lbs.; no B. B. 195 lbs.

C.....	\$38.00
D.....	35.00
F.....	33.50
G.....	33.00
H.....	32.25
I.....	31.50
K.....	30.50
L.....	29.50

If B. B. is omitted deduct \$6.60

No. 4339

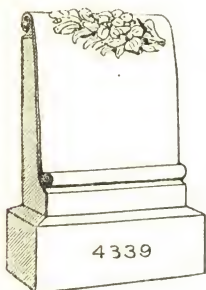

Die.....1.10 x 0.10 x 2.4..3.7
 B. Base.....2.4 x 1.4 x 1.0..3.1

Weight complete 1075 lbs.; no B. B. 520 lbs.

C.....	\$120.00
D.....	112.00
F.....	108.00
G.....	106.00
H.....	105.00
I.....	103.00
K.....	100.00
L.....	97.50

If B. B. is omitted deduct \$10.80

No. 4340

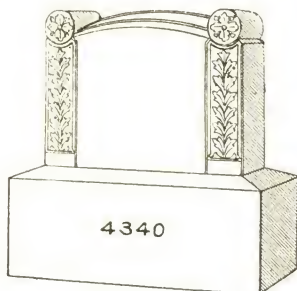

Die.....2.2 x 0.10 x 1.8..3.0
 B. Base.....2.8 x 1.4 x 1.0..3.7

Weight complete 1150 lbs.; no B. B. 505 lbs.

C.....	\$66.00
D.....	59.00
F.....	56.00
G.....	54.50
H.....	53.00
I.....	51.50
K.....	49.25
L.....	47.00

If B. B. is omitted deduct \$12.55

No. 4340¹/₄

Die.....2.0 x 0.8 x 1.6..2.0
 B. Base.....2.6 x 1.2 x 1.0..2.11

Weight complete 850 lbs.; no B. B. 325 lbs.

C.....	\$46.75
D.....	42.25
F.....	40.25
G.....	39.25
H.....	38.25
I.....	37.25
K.....	35.75
L.....	34.25

If B. B. is omitted deduct \$10.50

No. 4339¹/₄

Die.....1.8 x 0.8 x 2.2..2.5
 B. Base.....2.2 x 1.2 x 0.10..2.1

Weight complete 775 lbs.; no B. B. 400 lbs

C.....	\$88.50
D.....	83.00
F.....	81.00
G.....	79.50
H.....	78.50
I.....	77.00
K.....	75.50
L.....	73.50

If B. B. is omitted deduct \$7.50

No. 4340¹/₂

Die.....1.10 x 0.6 x 1.4..1.3
 B. Base.....2.2 x 0.10 x 0.10..1.6

Weight complete 475 lbs.; no B. B. 205 lbs

C.....	\$30.00
D.....	27.25
F.....	25.75
G.....	25.25
H.....	24.50
I.....	24.00
K.....	23.00
L.....	22.00

If B. B. is omitted deduct \$5.40

No. 4343

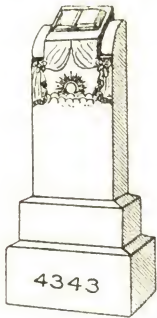

Die.....1.4 x 0.10 x 3.0..3.4
 Base.....1.8 x 1.2 x 0.8..1.4
 B. Base....2.0 x 1.6 x 1.0..3.0
 Weight complete 1300 lbs.; no B. B. 760 lbs.

- C.....\$90.00
- D.....79.50
- F.....74.50
- G.....72.50
- H.....70.00
- I.....67.50
- K.....64.00
- L.....60.50

If B. B. is omitted deduct \$10.80

No. 4343¹/₄

Die.....1.2 x 0.8 x 2.6..1.11
 Base.....1.6 x 1.0 x 0.8..1.0
 B. Base...1.10 x 1.4 x 0.10..2.0
 Weight complete 800 lbs.; no B. B. 440 lbs.

- C.....\$61.00
- D.....54.50
- F.....51.00
- G.....50.00
- H.....48.50
- I.....47.25
- K.....45.00
- L.....42.75

If B. B. is omitted deduct \$7.20

No. 4343¹/₂

Die.....1.0 x 0.6 x 2.2..1.1
 Base.....1.4 x 0.10 x 0.6..0.7
 B. Base....1.8 x 1.2 x 0.10..1.7
 Weight complete 550 lbs.; no B. B. 265 lbs.

- C.....\$40.00
- D.....36.25
- F.....34.75
- G.....33.75
- H.....33.00
- I.....32.25
- K.....31.00
- L.....29.75

If B. B. is omitted deduct \$5.70

No. 4344

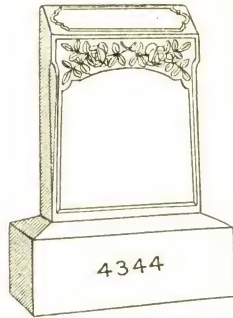

Die.....1.6 x 0.6 x 2.0..1.6
 B. Base....2.0 x 1.0 x 0.10..1.8
 Weight complete 550 lbs.; no B. B. 250 lbs.

- C.....\$33.00
- D.....29.50
- F.....28.00
- G.....27.25
- H.....26.50
- I.....25.75
- K.....24.50
- L.....23.50

If B. B. is omitted deduct \$6.00

No. 4344¹/₄

Die.....1.6 x 0.4 x 2.0..1.0
 B. Base....2.0 x 0.10 x 0.10..1.5
 Weight complete 425 lbs.; no B. B. 170 lbs.

- C.....\$25.00
- D.....22.75
- F.....21.75
- G.....21.25
- H.....20.75
- I.....20.25
- K.....19.50
- L.....18.75

If B. B. is omitted deduct \$5.10

No. 4348

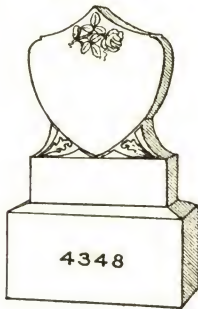

Die.....1.4 x 0.6 x 1.10..1.3
 B. Base....1.8 x 0.10 x 0.8..0.11
 Weight complete 375 lbs.; no B. B. 210 lbs.

C.....	\$27.00
D.....	24.25
F.....	22.75
G.....	22.25
H.....	21.50
I.....	21.00
K.....	20.00
L.....	19.00

If B. B. is omitted deduct \$3.45

No. 4348¹/₄

Die.....1.2 x 0.6 x 1.6..0.11
 B. Base....1.6 x 0.10 x 0.8..0.10
 Weight complete 300 lbs.; no B. B. 135 lbs.

C.....	\$20.75
D.....	18.75
F.....	17.75
G.....	17.25
H.....	16.75
I.....	16.50
K.....	15.75
L.....	15.00

If B. B. is omitted deduct \$3.15

No. 4348¹/₂

Die.....1.2 x 0.4 x 1.6..0.7
 B. Base....1.6 x 0.8 x 0.8..0.8
 Weight complete 225 lbs.; no B. B. 105 lbs.

C.....	\$15.75
D.....	14.50
F.....	14.00
G.....	13.75
H.....	13.25
I.....	13.00
K.....	12.75
L.....	12.25

If B. B. is omitted deduct \$2.50

No. 4348³/₄

See next column.

No. 4350

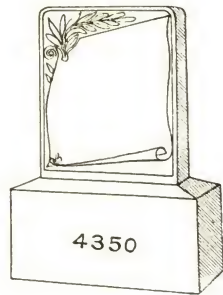

Die.....1.2 x 0.4 x 1.6..0.7
 B. Base....1.6 x 0.8 x 0.8..0.8
 Weight complete 225 lbs.; no B. B. 105 lbs.

C.....	\$14.50
D.....	13.25
F.....	12.75
G.....	12.50
H.....	12.00
I.....	11.75
K.....	11.50
L.....	11.00

If B. B. is omitted deduct \$2.50

No. 4350¹/₄

Die.....1.0 x 0.4 x 1.4..0.5
 B. Base....1.4 x 0.8 x 0.8..0.7
 Weight complete 180 lbs.; no B. B. 75 lbs.

C.....	\$12.25
D.....	11.25
F.....	11.00
G.....	10.75
H.....	10.50
I.....	10.25
K.....	9.75
L.....	9.50

If B. B. is omitted deduct \$2.20

No. 4348³/₄

Die.....1.0 x 0.4 x 1.4..0.5
 B. Base....1.4 x 0.8 x 0.8..0.7
 Weight complete 180 lbs.; no B. B. 75 lbs.

C.....	\$13.75
D.....	12.75
F.....	12.50
G.....	12.25
H.....	12.00
I.....	11.75
K.....	11.25
L.....	11.00

If B. B. is omitted deduct \$2.20

No. 4363

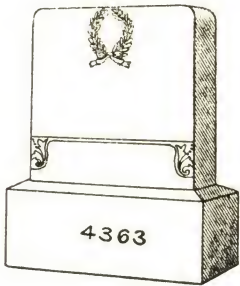

Die.....2. 4 x 0.10 x 2.6. .4.10
 B. Base.....2.10 x 1. 4 x 1.2. .4. 5
 Weight complete 1650 lbs.; no B. B. 855 lbs.

- C.....\$88.50
- D.....77.50
- F.....72.50
- G.....70.00
- H.....68.00
- I.....65.50
- K.....61.50
- L.....58.00

If B. B. is omitted deduct \$15.45

No. 4363¹/₄

Die.....2.0 x 0.8 x 2.2. .2.11
 B. Base.....2.6 x 1.2 x 1.0. .2.11
 Weight complete 1050 lbs.; no B. B. 525 lbs.

- C.....\$56.00
- D.....49.50
- F.....46.50
- G.....45.00
- H.....43.50
- I.....42.25
- K.....40.00
- L.....37.75

If B. B. is omitted deduct \$10.50

No. 4363¹/₂

Die.....1.6 x 0.6 x 1. 8. .1.3
 B. Base.....2.0 x 1.0 x 0.10. .1.8
 Weight complete 525 lbs.; no B. B. 225 lbs.

- C.....\$27.50
- D.....24.50
- F.....23.25
- G.....22.75
- H.....22.00
- I.....21.50
- K.....20.50
- L.....19.50

If B. B. is omitted deduct \$6.00

No. 4364

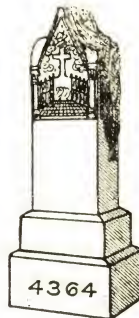

Die.....1. 7 x 0.10 x 4.0. .5.3
 Base.....1.10 x 1. 2 x 0.8. .1.5
 B. Base.....2. 4 x 1. 8 x 1.2. .4.6

Weight complete 1950 lbs.; no B.B.1140 lbs

- C.....\$137.00
- D.....122.00
- F.....116.00
- G.....112.00
- H.....109.00
- I.....106.00
- K.....101.00
- L.....95.50

If B. B. is omitted deduct \$15.75

No. 4364¹/₄

Die.....1.5 x 0.10 x 3.6. .4.2
 Base.....1.8 x 1. 2 x 0.8. .1.4
 B. Base.....2.2 x 1. 8 x 1.0. .3.7

Weight complete 1600 lbs.; no B. B. 955 lbs.

- C.....\$111.00
- D.....98.50
- F.....93.00
- G.....90.00
- H.....87.50
- I.....84.50
- K.....80.50
- L.....76.50

If B. B. is omitted deduct \$12.55

No. 4364¹/₂

Die.....1.3 x 0.8 x 3.0. .2.6
 Base.....1.6 x 1.0 x 0.8. .1.0
 B. Base.....2.0 x 1.6 x 1.0. .3.0

Weight complete 1150 lbs.; no B. B. 610 lbs

- C.....\$80.50
- D.....72.50
- F.....69.50
- G.....67.50
- H.....66.00
- I.....64.00
- K.....61.50
- L.....59.00

If B. B. is omitted deduct \$10.80

No. 4369

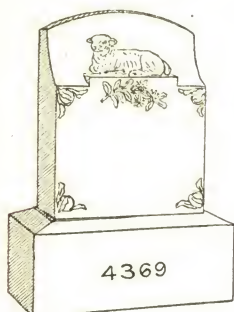

Die.....1.4 x 0.8 x 1. 8..1.6
 B. Base.....1.8 x 1.0 x 0.10..1.5
 Weight complete 500 lbs.; no B. B. 245 lbs.

C.....	\$39.75
D.....	36.25
F.....	34.75
G.....	34.00
H.....	33.25
I.....	32.50
K.....	31.25
L.....	30.25

If B. B. is omitted deduct \$5.10

No. 4370

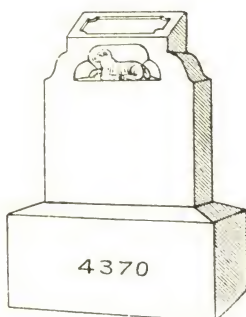

Die.....1.2 x 0.4 x 1.6..0.7
 B. Base.....1.6 x 0.8 x 0.8..0.8
 Weight complete 225 lbs.; no B. B. 100 lbs.

C.....	\$21.00
D.....	19.75
F.....	19.25
G.....	19.00
H.....	18.50
I.....	18.25
K.....	18.00
L.....	17.50

If B. B. is omitted deduct \$2.50

No. 4369¹/₄

Die.....1.2 x 0. 6 x 1.6..0.11
 B. Base.....1.6 x 0.10 x 0.8..0.10
 Weight complete 300 lbs.; no B. B. 150 lbs.

C.....	\$28.50
D.....	26.50
F.....	25.50
G.....	25.00
H.....	24.50
I.....	24.25
K.....	23.50
L.....	22.75

If B. B. is omitted deduct \$3.15

No. 4369¹/₂

Die.....1.0 x 0. 6 x 1.4..0.8
 B. Base.....1.4 x 0.10 x 0.8..0.9
 Weight complete 250 lbs.; no B. B. 115 lbs.

C.....	\$24.25
D.....	22.75
F.....	22.25
G.....	21.75
H.....	21.50
I.....	21.25
K.....	20.75
L.....	20.25

If B. B. is omitted deduct \$2.80

No. 4370¹/₄

Die.....1.0 x 0.4 x 1.2..0.5
 B. Base.....1.4 x 0.8 x 0.8..0.7
 Weight complete 175 lbs.; no B. B. 70 lbs.

C.....	\$17.25
D.....	16.25
F.....	16.00
G.....	15.75
H.....	15.50
I.....	15.25
K.....	14.75
L.....	14.50

If B. B. is omitted deduct \$2.20

No. 4371

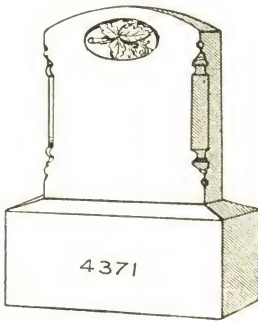

Die.....1.2 x 0.4 x 1.6..0.7
 B. Base.....1.6 x 0.8 x 0.8..0.8
 Weight complete 225 lbs.; no B. B. 100 lbs.

- C.....\$21.75
 - D.....20.50
 - F.....20.00
 - G.....19.75
 - H.....19.25
 - I.....19.00
 - K.....18.75
 - L.....18.25
- If B. B. is omitted deduct \$2.50

No. 4372

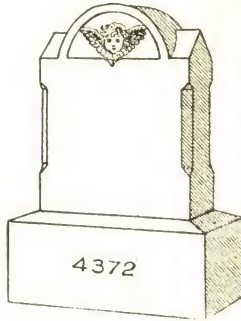

Die.....1.2 x 0.6 x 1.6..0.11
 B. Base.....1.6 x 0.10 x 0.8..0.10
 Weight complete 300 lbs.; no B. B. 150 lbs.

- C.....\$33.25
 - D.....31.25
 - F.....30.25
 - G.....29.75
 - H.....29.25
 - I.....29.00
 - K.....28.25
 - L.....27.50
- If B. B. is omitted deduct \$3.15

No. 4371¹/₄

Die.....1.0 x 0.4 x 1.2..0.5
 B. Base.....1.4 x 0.8 x 0.8..0.7
 Weight complete 175 lbs.; no B. B. 70 lbs.

- C.....\$18.00
 - D.....17.00
 - F.....16.75
 - G.....16.50
 - H.....16.25
 - I.....16.00
 - K.....15.50
 - L.....15.25
- If B. B. is omitted deduct \$2.20

No. 4372¹/₄

Die.....1.0 x 0.6 x 1.4..0.8
 B. Base.....1.4 x 0.10 x 0.8..0.9
 Weight complete 250 lbs.; no B. B. 115 lbs.

- C.....\$28.50
 - D.....27.00
 - F.....26.50
 - G.....26.00
 - H.....25.75
 - I.....25.50
 - K.....25.00
 - L.....24.50
- If B. B. is omitted deduct \$2.80

No. 4373

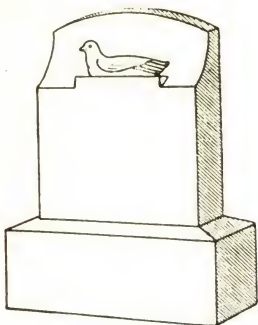

Die.....1.2 x 0.6 x 1.6..0.11
 B. Base.....1.6 x 0.10 x 0.8..0.10
 Weight complete 300 lbs.; no B. B. 150 lbs.

C.....	\$30 75
D.....	28.75
F.....	27.75
G.....	27.25
H.....	26.75
I.....	26.50
K.....	25.75
L.....	25.00

If B. B. is omitted deduct \$3.15

No. 4375

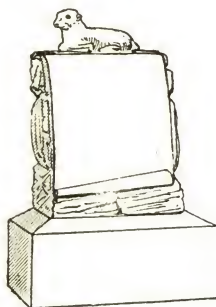

Die.....1.2 x 0.8 x 1.8..1.4
 B. Base.....1.6 x 1.0 x 0.8..1.0
 Weight complete 350 lbs.; no B. B. 170 lbs.

C.....	\$38.00
D.....	35.00
F.....	33.50
G.....	33.00
H.....	32.25
I.....	31.50
K.....	30.50
L.....	29.50

If B. B. is omitted deduct \$3.75

No. 4373¹/₄

Die.....1.0 x 0.6 x 1.4..0.8
 B. Base.....1.4 x 0.10 x 0.8..0.9
 Weight complete 250 lbs.; no B. B. 115 lbs.

C.....	\$26.50
D.....	25.00
F.....	24.50
G.....	24.00
H.....	23.75
I.....	23.50
K.....	23.00
L.....	22.50

If B. B. is omitted deduct \$2.80

No. 4375¹/₄

Die.....1.0 x 0.8 x 1.6..1.0
 B. Base.....1.4 x 1.0 x 0.8..1.1
 Weight complete 300 lbs.; no B. B. 135 lbs.

C.....	\$31.25
D.....	29.00
F.....	28.00
G.....	27.50
H.....	27.00
I.....	26.50
K.....	25.75
L.....	25.00

If B. B. is omitted deduct \$3.45

No. 4376

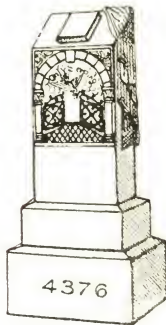

Die.....1.5 x 0.10 x 3.0..3.7
 Base.....1.8 x 1.2 x 0.8..1.4
 B. Base.....2.0 x 1.6 x 1.0..3.0
 Weight complete 1350 lbs.; no B. B. 810 lbs.
 C.....\$107.00
 D.....96.00
 F.....91.00
 G.....88.50
 H.....86.00
 I.....82.50
 K.....80.00
 L.....76.50
 If B. B. is omitted deduct \$10.80
 If open book is wanted, extra \$1.50

No. 4376¹/₄

Die.....1.3 x 0.8 x 2.6..2.1
 Base.....1.6 x 1.0 x 0.8..1.0
 B. Base.....1.10 x 1.4 x 0.10..2.0
 Weight complete 875 lbs.; no B. B. 515 lbs.
 C.....\$74.50
 D.....67.50
 F.....64.50
 G.....63.00
 H.....61.50
 I.....60.00
 K.....57.50
 L.....55.00
 If B. B. is omitted deduct \$7.20
 If open book is wanted, extra \$1.50]

No. 4376¹/₂

Die.....1.1 x 0.6 x 2.2..1.2
 Base.....1.4 x 0.10 x 0.6..0.7
 B. Base.....1.8 x 1.2 x 0.10..1.7
 Weight complete 550 lbs.; no B. B. 265 lbs.
 C.....\$52.00
 D.....48.25
 F.....46.25
 G.....45.50
 H.....44.50
 I.....43.75
 K.....42.50
 L.....41.00
 If B. B. is omitted deduct \$5.70
 If open book is wanted, extra \$1.50

No. 4377

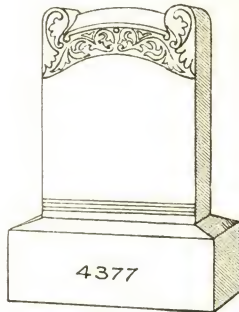

Die.....1.6 x 0.6 x 2.0..1.6
 B. Base.....2.0 x 1.0 x 0.10..1.8
 Weight complete 550 lbs.; no B. B. 250 lbs.
 C.....\$36.00
 D.....32.50
 F.....31.00
 G.....30.25
 H.....29.50
 I.....28.75
 K.....27.50
 L.....26.50
 If B. B. is omitted deduct \$6.00

No. 4377¹/₄

Die.....1.6 x 0.4 x 2.0..1.0
 B. Base.....2.0 x 0.10 x 0.10..1.5
 Weight complete 425 lbs.; no B. B. 170 lbs.
 C.....\$26.25
 D.....24.00
 F.....23.00
 G.....22.50
 H.....22.00
 I.....21.50
 K.....20.75
 L.....20.00
 If B. B. is omitted deduct \$5.10

No. 4378

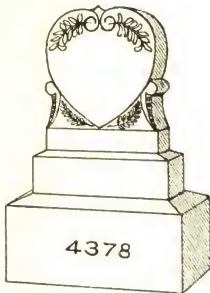

Die.....1.2x0.6x1.6.0.11
 Base.....1.4x0.8x0.4.0.4
 B. Base....1.8x1.0x0.10.1.5
 Weight complete 450 lbs.; no B. B. 200 lbs.
 C.....\$30.00
 D.....27.00
 F.....25.75
 G.....25.25
 H.....24.50
 I.....24.00
 K.....23.00
 L.....22.00
 If B. B. is omitted deduct \$5.10

No. 4378¹/₄

Die.....1.2x0.4x1.6.0.7
 Base.....1.4x0.6x0.4.0.3
 B. Base....1.8x0.10x0.8.0.11
 Weight complete 300 lbs.; no B. B. 135 lbs.
 C.....\$22.25
 D.....20.50
 F.....19.50
 G.....19.25
 H.....18.75
 I.....18.25
 K.....17.75
 L.....17.00
 If B. B. is omitted deduct \$3.45

No. 4378¹/₂

Die.....1.0x0.4x1.2.0.5
 Base.....1.2x0.6x0.4.0.2
 B. Base....1.6x0.10x0.8.0.10
 Weight complete 250 lbs.; no B. B. 100 lbs.
 C.....\$16.25
 D.....15.00
 F.....14.50
 G.....14.25
 H.....13.75
 I.....13.50
 K.....13.25
 L.....12.75
 If B. B. is omitted deduct \$3.15

No. 4379

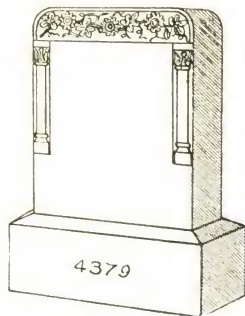

Die.....2.4x0.10x2.6.4.10
 B. Base....2.10x1.4x1.0.3.9
 Weight complete 1500 lbs.; no B. B. 825 lbs.
 C.....\$86.50
 D.....75.50
 F.....70.50
 G.....68.00
 H.....66.00
 I.....63.50
 K.....59.50
 L.....56.00
 If B. B. is omitted deduct \$13.15

No. 4379¹/₄

Die.....2.0x0.8x2.2.2.11
 B. Base....2.6x1.2x1.0.2.11
 Weight complete 1050 lbs.; no B. B. 525 lbs.
 C.....\$56.00
 D.....49.50
 F.....46.50
 G.....45.00
 H.....43.50
 I.....42.25
 K.....40.00
 L.....37.75
 If B. B. is omitted deduct \$10.50

No. 4379¹/₂

Die.....1.6x0.6x1.8.1.13
 B. Base....2.0x1.0x0.10.1.8
 Weight complete 525 lbs.; no B. B. 225 lbs.
 C.....\$27.50
 D.....24.50
 F.....23.25
 G.....22.75
 H.....22.00
 I.....21.50
 K.....20.50
 L.....19.50
 If B. B. is omitted deduct \$6.00

No. 4385

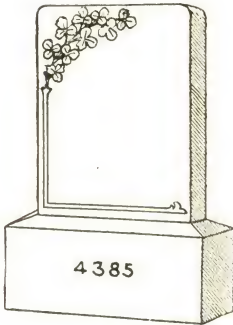

Die.....1.2 x 0.4 x 1.6..0.7
 B. Base.....1.6 x 0.8 x 0.8..0.8
 Weight complete 225 lbs.; no B. B. 105 lbs.

C.....	\$14.50
D.....	13.25
F.....	12.75
G.....	12.50
H.....	12.00
I.....	11.75
K.....	11.50
L.....	11.00

If B. B. is omitted deduct \$2.50

No. 4387

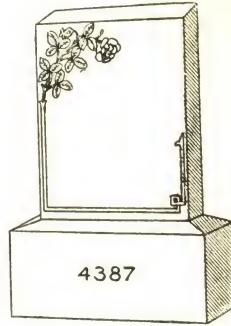

Die.....1.2 x 0.4 x 1.6..0.7
 B. Base.....1.6 x 0.8 x 0.8..0.8
 Weight complete 225 lbs.; no B. B. 105 lbs.

C.....	\$14.50
D.....	13.25
F.....	12.75
G.....	12.50
H.....	12.00
I.....	11.75
K.....	11.50
L.....	11.00

If B. B. is omitted deduct \$2.50

No. 4385 $\frac{1}{4}$

Die.....1.0 x 0.4 x 1.4..0.5
 B. Base.....1.4 x 0.8 x 0.8..0.7
 Weight complete 180 lbs.; no B. B. 75 lbs.

C.....	\$11.50
D.....	10.50
F.....	10.00
G.....	9.75
H.....	9.50
I.....	9.25
K.....	9.00
L.....	8.75

If B. B. is omitted deduct \$2.20

No. 4387 $\frac{1}{4}$

Die.....1.0 x 0.4 x 1.4..0.5
 B. Base.....1.4 x 0.8 x 0.8..0.7
 Weight complete 180 lbs.; no B. B. 75 lbs.

C.....	\$11.50
D.....	10.50
F.....	10.00
G.....	9.75
H.....	9.50
I.....	9.25
K.....	9.00
L.....	8.75

If B. B. is omitted deduct \$2.20

No. 4386

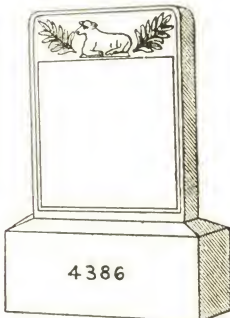

Same sizes and prices as No. 4385.

No. 4388

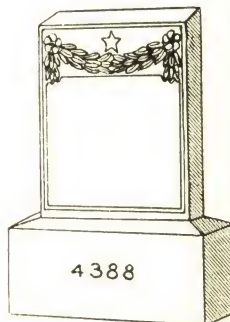

Same sizes and prices as No. 4387.

No. 4393

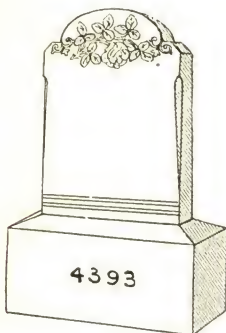

Die.....1. 4 x 0. 4 x 1.10..0.10
 B. Base...1.10 x 0.10 x 0.10..1. 3
 Weight complete 375 lbs.; no B. B. 150 lbs.

- C.....\$21.75
- D.....20.00
- F.....19.00
- G.....18.75
- H.....18.25
- I.....17.75
- K.....17.25
- L.....16.50

If B. B. is omitted deduct \$4.50

No. 4393¹/₄

Die.....1. 2 x 0.4 x 1.8..0.8
 B. Base....1.6 x 0.8 x 0.8..0.8
 Weight complete 225 lbs.; no B. B. 105 lbs.

- C.....\$17.00
- D.....15.50
- F.....15.00
- G.....14.50
- H.....14.25
- I.....14.00
- K.....13.50
- L.....13.00

If B. B. is omitted deduct \$2.50

No. 4397

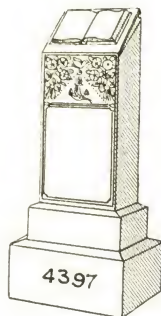

Die.....1. 6 x 1. 0 x 3.6..5.3
 Base.....1.10 x 1. 4 x 0.8..1.8
 B. Base....2. 4 x 1.10 x 1.2..5.0
 Weight complete 2000 lbs.; no B. B. 1100 lbs.

- C.....\$130.00
- D.....114.00
- F.....108.00
- G.....104.00
- H.....101.00
- I.....97.00
- K.....92.00
- L.....87.00

If B. B. is omitted deduct \$17.50

No. 4397¹/₄

Die.....1. 4 x 0.10 x 3.0..3.4
 Base.....1.8 x 1. 2 x 0.8..1.4
 B. Base....2. 0 x 1. 6 x 1.0..3.0
 Weight complete 1250 lbs.; no B. B. 710 lbs.

- C.....\$90.00
- D.....79.50
- F.....74.50
- G.....72.50
- H.....70.00
- I.....67.50
- K.....64.00
- L.....60.50

If B. B. is omitted deduct \$10.80

No. 4397¹/₂

Die.....1. 2 x 0.8 x 2. 6..1.11
 Base.....1. 6 x 1.0 x 0. 8..1. 0
 B. Base....1.10 x 1.4 x 0.10..2. 0
 Weight complete 800 lbs.; no B. B. 440 lbs.

- C.....\$61.00
- D.....54.50
- F.....51.50
- G.....50.00
- H.....48.50
- I.....47.25
- K.....45.00
- L.....42.75

If B. B. is omitted deduct \$7.20

No. 4397³/₄

See next page

No. 4398

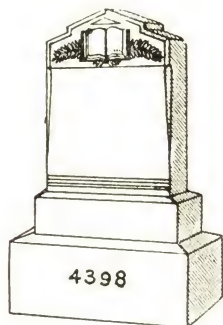

Die.....1.6 x 0.6 x 2. 0..1.6
 Base.....1.9 x 0.9 x 0. 5..0.7
 B. Base.....2.2 x 1.2 x 0.10..2.1
 Weight complete 700 lbs.; no B. B. 325 lbs.

- C.....\$44.75
- D.....40.00
- F.....38.00
- G.....37.00
- H.....35.75
- I.....34.75
- K.....33.25
- L.....31.75

If B. B. is omitted deduct \$7.50

No. 4401

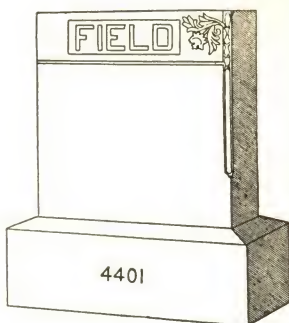

Die.....2. 4 x 0.10 x 2.4..4.6
 B. Base.....2.10 x 1. 4 x 1.0..3.9
 Weight complete 1475 lbs.; no B. B. 800 lbs.

- C.....\$82.00
- D.....72.00
- F.....67.50
- G.....65.00
- H.....63.00
- I.....60.50
- K.....57.00
- L.....54.00

If B. B. is omitted deduct \$13.15

No. 4398¹/₄

Die.....1.6 x 0.4 x 2. 0..1. 0
 Base.....1.9 x 0.7 x 0. 4..0. 4
 B. Base.....2.2 x 1.0 x 0.10..1.10
 Weight complete 550 lbs.; no B. B. 220 lbs.

- C.....\$32.50
- D.....29.50
- F.....28.00
- G.....27.50
- H.....26.75
- I.....26.00
- K.....25.00
- L.....24.00

If B. B. is omitted deduct \$6.60

No. 4401¹/₄

Die.....2.0 x 0.8 x 2.0..2. 8
 B. Base.....2.6 x 1.2 x 1.0..2.11
 Weight complete 1000 lbs.; no B. B. 475 lbs.

- C.....\$53.00
- D.....47.00
- F.....44.50
- G.....43.00
- H.....41.75
- I.....40.50
- K.....38.50
- L.....36.50

If B. B. is omitted deduct \$10.50

No. 4397³/₄

Die.....1.0 x 0. 6 x 2. 2..1.1
 Base.....1.4 x 0.10 x 0. 6..0.7
 B. Base.....1.8 x 1. 2 x 0.10..1.7
 Weight complete 550 lbs.; no B. B. 200 lbs.

- C.....\$40.00
- D.....36.25
- F.....34.75
- G.....33.75
- H.....33.00
- I.....32.25
- K.....31.00
- L.....29.75

If B. B. is omitted deduct \$5.70

No. 4401¹/₂

Die.....1.6 x 0.6 x 1. 6..1.2
 B. Base.....2.0 x 1.0 x 0.10..1.8
 Weight complete 500 lbs.; no B. B. 200 lbs.

- C.....\$26.75
- D.....24.00
- F.....23.00
- G.....22.25
- H.....21.75
- I.....21.25
- K.....20.25
- L.....19.50

If B. B. is omitted deduct \$6.00

No. 4403

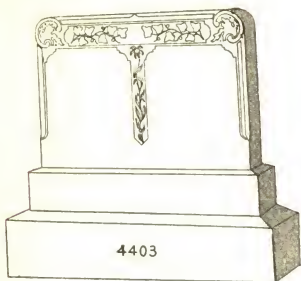

Die.....2. 8 x 0.6 x 1.10..2.5
 Base.....2.11 x 0.9 x 0.6..1.1
 B. Base....3. 4 x 1.2 x 0.10..3.3

Weight complete 1200 lbs.; no B. B. 615 lbs.

C.....	\$69.50
D.....	61.50
F.....	58.50
G.....	56.50
H.....	55.00
I.....	53.00
K.....	50.50
L.....	47.75

If B. B. is omitted deduct \$11.40

No. 4404

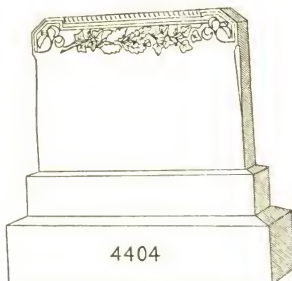

Die.....2. 8 x 0.6 x 1.10..2.5
 Base.....2.11 x 0.9 x 0.6..1.1
 B. Base....3. 4 x 1.2 x 0.10..3.3

Weight complete 1200 lbs.; no B. B. 615 lbs.

C.....	\$71.50
D.....	63.50
F.....	60.50
G.....	58.50
H.....	57.00
I.....	55.00
K.....	52.50
L.....	49.75

If B. B. is omitted deduct \$11.40

No. 4403¹/₄

Die.....2. 8 x 0.4 x 1.10..1.8
 Base.....2.11 x 0.7 x 0.5..0.9
 B. Base....3. 4 x 1.0 x 0.10..2.9

Weight complete 925 lbs.; no B. B. 430 lbs.

C.....	\$52.50
D.....	47.00
F.....	44.50
G.....	43.25
H.....	42.00
I.....	41.00
K.....	39.00
L.....	37.25

If B. B. is omitted deduct \$9.90

No. 4404¹/₄

Die.....2. 8 x 0.4 x 1.10..1.8
 Base.....2.11 x 0.7 x 0.5..0.9
 B. Base....3. 4 x 1.0 x 0.10..2.9

Weight complete 925 lbs.; no B. B. 430 lbs.

C.....	\$55.00
D.....	49.50
F.....	47.00
G.....	45.75
H.....	44.50
I.....	43.50
K.....	41.50
L.....	39.25

If B. B. is omitted deduct \$9.90

No. 4405

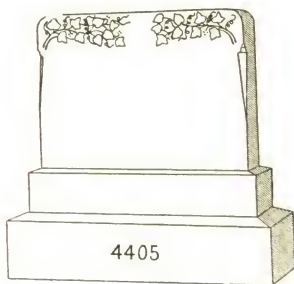

Die.....2. 8 x 0.6 x 1.10..2.5
 Base.....2.11 x 0.9 x 0. 6..1.1
 B. Base....3. 4 x 1.2 x 0.10..3.3

Weight complete 1200 lbs.; no B. B. 615 lbs.

C.....	\$68.50
D.....	60.50
F.....	57.50
G.....	55.50
H.....	54.00
I.....	52.00
K.....	49.50
L.....	46.75

If B. B. is omitted deduct \$11.40

No. 4406

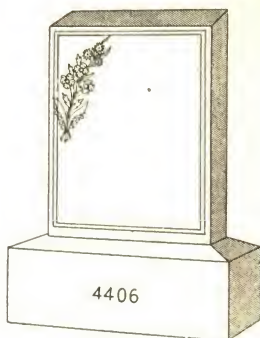

Die.....1.6 x 0.6 x 2. 0..1.6
 B. Base....2.0 x 1.0 x 0.10..1.8

Weight complete 550 lbs.; no B. B. 250 lbs.

C.....	\$32.50
D.....	29.00
F.....	27.50
G.....	26.75
H.....	26.00
I.....	25.25
K.....	24.00
L.....	23.00

If B. B. is omitted deduct \$6.00

No. 4405 $\frac{1}{4}$

Die.....2. 8 x 0.4 x 1.10..1.8
 Base.....2.11 x 0.7 x 0. 5..0.9
 B. Base....3. 4 x 1.0 x 0.10..2.9

Weight complete 925 lbs.; no B. B. 430 lbs.

C.....	\$52.50
D.....	47.00
F.....	44.50
G.....	43.25
H.....	42.00
I.....	41.00
K.....	39.00
L.....	37.25

If B. B. is omitted deduct \$9.90

No. 4406 $\frac{1}{4}$

Die.....1.6 x 0. 4 x 2. 0..1.0
 B. Base....2.0 x 0.10 x 0.10..1.5

Weight complete 425 lbs.; no B. B. 160 lbs.

C.....	\$23.25
D.....	21.00
F.....	20.00
G.....	19.50
H.....	19.00
I.....	18.50
K.....	17.75
L.....	17.00

If B. B. is omitted deduct \$5.10

No. 4409

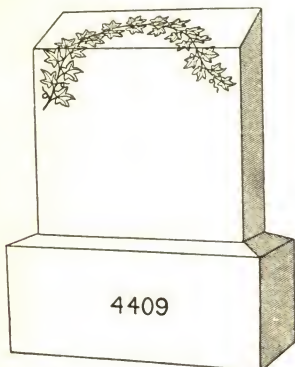

Die.....2. 4 x 0.10 x 2.6. .4.10
 B. Base.....2.10 x 1. 4 x 1.2. .4.5
 Weight complete 1650 lbs.; no B. B. 855 lbs.

- C.....\$90.00
- D.....79.00
- F.....74.00
- G.....71.50
- H.....69.50
- I.....67.00
- K.....63.00
- L.....59.50

If B. B. is omitted deduct \$15.45

No. 4410



Die.....1.2 x 0.4 x 1.4. .0.6
 B. Base.....1.6 x 0.8 x 0.8. .0.8
 Weight complete 200 lbs.; no B. B. 80 lbs.

- C.....\$14.50
- D.....13.25
- F.....12.75
- G.....12.50
- H.....12.25
- I.....12.00
- K.....11.50
- L.....11.25

If B. B. is omitted deduct \$2.50

No. 4409¹/₄

Die.....2.0 x 0.8 x 2.2. .2.11
 B. Base.....2.6 x 1.2 x 1.0. .2.11
 Weight complete 1025 lbs.; no B. B. 500 lbs.

- C.....\$58.50
- D.....52.00
- F.....49.00
- G.....47.50
- H.....46.00
- I.....44.75
- K.....42.50
- L.....40.25

If B. B. is omitted deduct \$10.50

No. 4409¹/₂

Die.....1.6 x 0.6 x 1. 8. .1.3
 B. Base.....2.0 x 1.0 x 0.10. .1.8
 Weight complete 525 lbs.; no B. B. 225 lbs.

- C.....\$29.50
- D.....26.75
- F.....25.25
- G.....24.75
- H.....24.00
- I.....23.50
- K.....22.50
- L.....21.50

If B. B. is omitted deduct \$6.00

No. 4410¹/₄

Die.....1.0 x 0.4 x 1.2. .0.5
 B. Base.....1.4 x 0.8 x 0.8. .0.7
 Weight complete 180 lbs.; no B. B. 75 lbs.

- C.....\$11.75
- D.....10.75
- F.....10.50
- G.....10.25
- H.....10.00
- I.....9.75
- K.....9.25
- L.....9.00

If B. B. is omitted deduct \$2.20

No. 4411

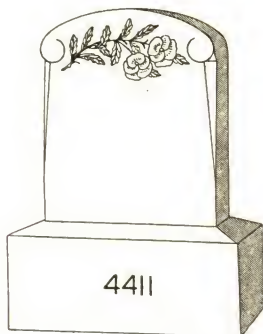

Die.....1.2 x 0.4 x 1.4 .0.6
 B. Base.....1.6 x 0.8 x 0.8 .0.8
 Weight complete 200 lbs.; no B. B. 80 lbs.

C.....	\$14.50
D.....	13.25
F.....	12.75
G.....	12.50
H.....	12.25
I.....	12.00
K.....	11.50
L.....	11.25

If B. B. is omitted deduct \$2.50

No. 4413



Die.....2.6 x 1.0 x 2.6 .6.3
 B. Base.....3.0 x 1.6 x 1.2 .5.3
 Weight complete 2050 lbs.; no B. B. 1105 lbs.

C.....	\$123.00
D.....	109.00
F.....	103.00
G.....	100.00
H.....	96.50
I.....	93.50
K.....	89.00
L.....	84.00

If B. B. is omitted deduct \$18.40

No. 4413¹/₄

Die.....2.4 x 0.10 x 2.4 .4.6
 B. Base.....2.10 x 1.4 x 1.0 .3.9
 Weight complete 1475 lbs.; no B. B. 805 lbs.

C.....	\$91.50
D.....	81.50
F.....	77.00
G.....	74.50
H.....	72.50
I.....	70.00
K.....	66.50
L.....	63.50

If B. B. is omitted deduct \$13.15

No. 4411¹/₄

Die.....1.0 x 0.4 x 1.2 .0.5
 B. Base.....1.4 x 0.8 x 0.8 .0.7
 Weight complete 180 lbs.; no B. B. 75 lbs.

C.....	\$11.75
D.....	10.75
F.....	10.50
G.....	10.25
H.....	10.00
I.....	9.75
K.....	9.25
L.....	9.00

If B. B. is omitted deduct \$2.20

No. 4413¹/₂

Die.....2.2 x 0.8 x 2.2 .3.2
 B. Base.....2.8 x 1.2 x 1.0 .3.1
 Weight complete 1100 lbs.; no B. B. 545 lbs.

C.....	\$68.50
D.....	61.50
F.....	58.50
G.....	57.00
H.....	55.50
I.....	53.50
K.....	51.50
L.....	49.00

If B. B. is omitted deduct \$10.80

No. 4417

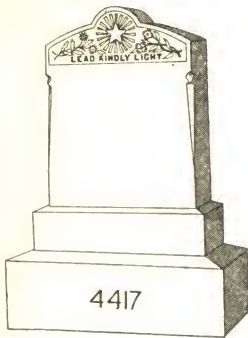

Die.....1.6 x 0.6 x 2. 0..1.6
 Base.....1.9 x 0.9 x 0. 5..0.7
 B. Base.....2.2 x 1.2 x 0.10..2.1

Weight complete 700 lbs.; no B. B. 325 lbs.

C.....	\$44.50
D.....	39.75
F.....	37.75
G.....	36.75
H.....	35.50
I.....	34.50
K.....	33.00
L.....	31.50

If B. B. is omitted deduct \$7.50

No. 4422

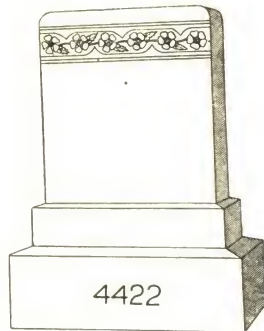

Die.....1.6 x 0.6 x 2. 0..1.6
 Base.....1.9 x 0.9 x 0. 5..0.7
 B. Base.....2.2 x 1.2 x 0.10..2.1

Weight complete 725 lbs.; no B. B. 350 lbs.

C.....	\$44.50
D.....	39.75
F.....	37.75
G.....	36.75
H.....	35.50
I.....	34.50
K.....	33.00
L.....	31.50

If B. B. is omitted deduct \$7.50

No. 4422¹/₄

Die.....1.6 x 0.6 x 1. 8..1.3
 Base.....1.8 x 0.8 x 0. 4..0.4
 B. Base.....2.0 x 1.0 x 0.10..1.8

Weight complete 550 lbs.; no B. B. 250 lbs.

C.....	\$35.75
D.....	32.25
F.....	30.75
G.....	30.00
H.....	29.00
I.....	28.25
K.....	27.25
L.....	26.00

If B. B. is omitted deduct \$6.00

No. 4417¹/₄

Die.....1.6 x 0.4 x 2. 0..1. 0
 Base.....1.9 x 0.7 x 0. 4..0. 4
 B. Base.....2.2 x 1.0 x 0.10..1.10

Weight complete 550 lbs.; no B. B. 220 lbs.

C.....	\$33.25
D.....	30.00
F.....	28.75
G.....	28.25
H.....	27.50
I.....	26.75
K.....	25.75
L.....	24.75

If B. B. is omitted deduct \$6.60

No. 4422¹/₂

Die.....1. 4 x 0. 4 x 1.6..0.8
 Base.....1. 6 x 0. 6 x 0.4..0.3
 B. Base.....1.10 x 0.10 x 0.8..1.0

Weight complete 325 lbs.; no B. B. 145 lbs.

C.....	\$22.00
D.....	20.00
F.....	19.00
G.....	18.50
H.....	18.00
I.....	17.75
K.....	17.00
L.....	16.25

If B. B. is omitted deduct \$3.75

No. 4423

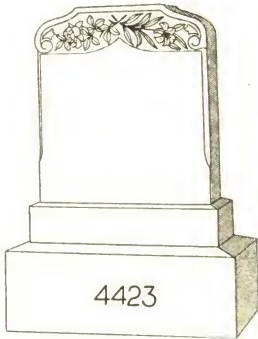

Die.....1.6 x 0.6 x 2. 0..1.6
 Base.....1.9 x 0.9 x 0. 5..0.7
 B. Base....2.2 x 1.2 x 0.10..2.1
 Weight complete 725 lbs.; no B. B. 350 lbs.

C.....	\$44.50
D.....	39.75
F.....	37.75
G.....	36.75
H.....	35.50
I.....	34.50
K.....	33.00
L.....	31.50

If B. B. is omitted deduct \$7.50

No. 4423¹/₄

Die.....1.6 x 0.6 x 1. 8..1.3
 Base.....1.8 x 0.8 x 0. 4..0.4
 B. Base....2.0 x 1.0 x 0.10..1.8
 Weight complete 550 lbs.; no B. B. 250 lbs.

C.....	\$35.75
D.....	32.25
F.....	30.75
G.....	30.00
H.....	29.25
I.....	28.25
K.....	27.25
L.....	26.00

If B. B. is omitted deduct \$6.00

No. 4423¹/₂

Die.....1. 4 x 0. 4 x 1.6..0.8
 Base.....1. 6 x 0. 6 x 0.4..0.3
 B. Base....1.10 x 0.10 x 0.8..1.0
 Weight complete 325 lbs.; no B. B. 145 lbs.

C.....	\$22.00
D.....	20.00
F.....	19.00
G.....	18.50
H.....	18.00
I.....	17.75
K.....	17.00
L.....	16.25

If B. B. is omitted deduct \$3.75

No. 4425

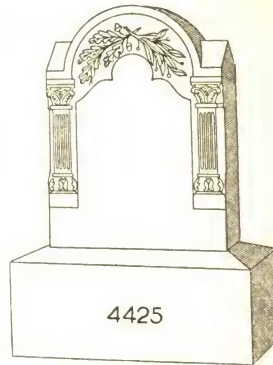

Die.....1.8 x 0.6 x 2. 6..2. 1
 B. Base....2.2 x 1.0 x 0.10..1.10
 Weight complete 675 lbs.; no B. B. 345 lbs.

C.....	\$45.75
D.....	41.00
F.....	39.00
G.....	38.00
H.....	36.75
I.....	35.75
K.....	34.25
L.....	32.75

If B. B. is omitted deduct \$6.60

No. 4425¹/₄

Die.....1.6 x 0.6 x 2. 0..1.6
 B. Base....2.0 x 1.0 x 0.10..1.8
 Weight complete 550 lbs.; no B. B. 250 lbs.

C.....	\$37.25
D.....	33.75
F.....	32.25
G.....	31.50
H.....	30.75
I.....	30.00
K.....	28.75
L.....	27.75

If B. B. is omitted deduct \$6.00

No. 4425¹/₂

Die.....1.6 x 0. 4 x 2. 0..1.0
 B. Base....2.0 x 0.10 x 0.10..1.5
 Weight complete 400 lbs.; no B. B. 145 lbs.

C.....	\$27.00
D.....	24.75
F.....	23.75
G.....	23.25
H.....	22.75
I.....	22.25
K.....	21.50
L.....	20.75

If B. B. is omitted deduct \$5.10

No. 4426

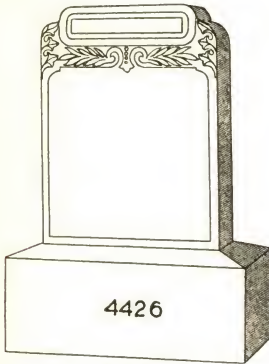

Die.....1.6 x 0.6 x 2. 0..1.6
 B. Base.....2.0 x 1.0 x 0.10..1.8
 Weight complete 550 lbs.; no B. B. 250 lbs.

- C.....\$35.00
 - D.....31.50
 - F.....30.00
 - G.....29.75
 - H.....28.50
 - I.....27.75
 - K.....26.50
 - L.....25.50
- If B. B. is omitted deduct \$6.00

No. 4429

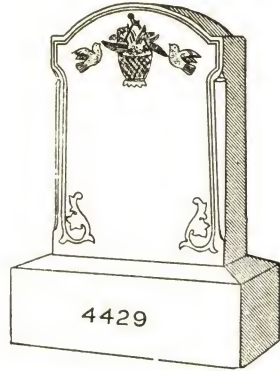

Die.....1.8 x 0.8 x 2.6..2.9
 B. Base.....2.2 x 1.2 x 1.0..2.6
 Weight complete 900 lbs.; no B. B. 450 lbs.

- C.....\$55.75
 - D.....49.75
 - F.....46.75
 - G.....45.50
 - H.....44.00
 - I.....42.75
 - K.....40.75
 - L.....38.50
- If B. B. is omitted deduct \$9.00

No. 4429¹/₄

Die.....1.6 x 0.6 x 2. 2..1.8
 B. Base.....2.0 x 1.0 x 0.10..1.8
 Weight complete 575 lbs.; no B. B. 275 lbs.

- C.....\$37.50
 - D.....33.75
 - F.....32.25
 - G.....31.25
 - H.....30.50
 - I.....29.75
 - K.....28.50
 - L.....27.25
- If B. B. is omitted deduct \$6.00

No. 4426¹/₄

Die.....1.6 x 0. 4 x 2. 0..1.0
 B. Base.....2.0 x 0.10 x 0.10..1.5
 Weight complete 425 lbs.; no B. B. 170 lbs.

- C.....\$25.75
 - D.....23.50
 - F.....22.50
 - G.....22.00
 - H.....21.50
 - I.....21.00
 - K.....20.25
 - L.....19.50
- If B. B. is omitted deduct \$5.10

No. 4429¹/₂

Die.....1.6 x 0. 4 x 2. 2..1.1
 B. Base.....2.0 x 0.10 x 0.10..1.5
 Weight complete 450 lbs.; no B. B. 195 lbs.

- C.....\$27.25
 - D.....24.75
 - F.....23.75
 - G.....23.25
 - H.....22.50
 - I.....22.00
 - K.....21.25
 - L.....20.50
- If B. B. is omitted deduct \$5.10

No. 4431

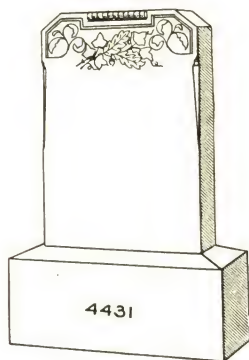

Die.....1.6 x 0.6 x 2. 0..1.6
 B. Base.....2.0 x 1.0 x 0.10..1.8
 Weight complete 550 lbs.; no B. B. 250 lbs.

- C.....\$35.00
 - D.....31.50
 - F.....30.00
 - G.....29.75
 - H.....28.50
 - I.....27.75
 - K.....26.50
 - L.....25.50
- If B. B. is omitted deduct \$6.00

No. 4439



Die.....2. 0 x 1.0 x 2.6..5. 0
 Base.....2. 3 x 1.3 x 0.8..1.11
 B. Base.....2. 9 x 1.9 x 1.0..4.10
 2 Sides.....5. 0 x 0.3 x 0.8..1. 8
 Foot.....2. 9 x 1.3 x 1.0..3. 5
 2 B. Sl.....4.10 x 0.6 x 0.2..0.10
 1 B. Sl.....3. 0 x 1.4 x 0.2..0. 8
 Weight complete 2800 lbs.; no B. B. and B. Slabs 1660 lbs.

- D.. \$290.00 I...\$257.00
- F.. 275.00 K... 248.00
- G.. 269.00 L... 239.00
- H.. 263.00

If B. B. and B. Slabs are omitted deduct \$23.50.

Foot and side pieces same grade as design.

Bottom base and slabs inferior. If better stock is wanted for bottom base and slabs add for difference.

No. 4440



Die.....1.6 x 0. 4 x 2. 0..1.0
 B Base....2.0 x 0 10 x 0.10..1.5
 Weight complete 425 lbs.; no B. B. 170 lbs

- C.....\$25.75
- D.....23.50
- F.....22.50
- G.....22.00
- H.....21.50
- I.....21 00
- K.....20.25
- L.....19.50

If B. B. is omitted deduct \$5.10

Die.....2.0 x 1.0 x 2.6..5. 0
 Base.....2.3 x 1.3 x 0.8..1.11
 B. Base.....2.9 x 1.9 x 1.0..4.10
 Weight complete 1750 lbs.; no B. B. 880 lbs.

- D.. \$181.00 I...\$164.00
- F.. 175.00 K... 159 00
- G.. 171.00 L... 154.00
- H. 168 00

If B. B is omitted deduct \$16.90

No. 4442



Die. 1. 7 x 0.10 x 4.0. . 5.3
 Base. 1.10 x 1. 2 x 0.8. . 1.5
 B. Base. . . . 2. 4 x 1. 8 x 1.2. . 4.6
 Weight complete 1950 lbs.; no B. B. 1140 lbs.

- C. \$157.00
- D. 142.00
- F. 136.00
- G. 132.00
- H. 129.00
- I. 126.00
- K. 121.00
- L. 116.00

If B. B. is omitted deduct \$15.75

No. 4442¹/₄

Die. 1.5 x 0.10 x 3.6. . 4.2
 Base. 1.8 x 1. 2 x 0.8. . 1.4
 B. Base. . . . 2.2 x 1. 8 x 1.0. . 3.7
 Weight complete 1550 lbs.; no B. B. 905 lbs.

- C. \$127.00
- D. 115.00
- F. 109.00
- G. 107.00
- H. 104.00
- I. 101.00
- K. 97.00
- L. 92.50

If B. B. is omitted deduct \$12.55

No. 4442¹/₂

Die. 1.3 x 0.8 x 3.0. . 2.6
 Base. 1.6 x 1.0 x 0.8. . 1.0
 B. Base. . . . 2.0 x 1.6 x 1.0. . 3.0
 Weight complete 1150 lbs.; no B. B. 610 lbs.

- C. \$97.50
- D. 89.50
- F. 86.50
- G. 84.50
- H. 83.00
- I. 81.00
- K. 78.50
- L. 76.00

If B. B. is omitted deduct \$10.80

No. 4448

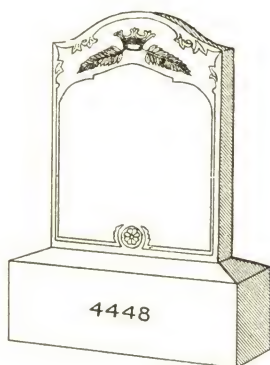

Die. 1.6 x 0.6 x 2. 0. . 1.6
 B. Base. 2.0 x 1.0 x 0.10. . 1.8
 Weight complete 550 lbs.; no B. B. 250 lbs.

- C. \$33.75
- D. 30.25
- F. 28.75
- G. 28.00
- H. 27.25
- I. 26.50
- K. 25.25
- L. 24.25

If B. B. is omitted deduct \$6.00

No. 4448¹/₄

Die. 1.6 x 0. 4 x 2. 0. . 1.0
 B. Base. . . . 2.0 x 0.10 x 0.10. . 1.5
 Weight complete 425 lbs.; no B. B. 170 lbs.

- C. \$26.00
- D. 23.25
- F. 22.25
- G. 21.75
- H. 21.25
- I. 20.75
- K. 20.00
- L. 19.25

If B. B. is omitted deduct \$5.10

No. 4449

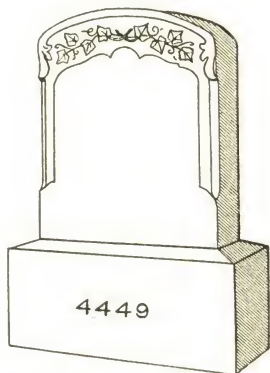

Die.....1.4 x 0.6 x 1.8..1.1
 B. Base....1.8 x 0.10 x 0.10..1.2
 Weight complete 375 lbs.; no B. B. 165 lbs.

C.....	\$25.50
D.....	23.00
F.....	22.00
G.....	21.50
H.....	20.75
I.....	20.25
K.....	19.50
L.....	18.25

If B. B. is omitted deduct \$4.20

No. 4450



Cross.....1.0 x 0.4 x 1.6..0.6
 Die.....2.0 x 0.8 x 2.2..2.11
 B. Base....2.6 x 1.2 x 1.0..2.11
 Weight complete 1050 lbs.; no B. B. 525 lbs.

C.....	\$85.00
D.....	77.00
F.....	74.00
G.....	72.00
H.....	70.50
I.....	68.50
K.....	66.00
L.....	63.50

If B. B. is omitted deduct \$10.50

No. 4450¹/₄

Cross.....0.10 x 0.3 x 1.2..0.3
 Die.....1.8 x 0.6 x 1.10..1.6
 B. Base....2.2 x 1.0 x 0.10..1.10
 Weight complete 550 lbs.; no B. B. 220 lbs.

C.....	\$53.50
D.....	49.50
F.....	47.50
G.....	46.75
H.....	45.75
I.....	45.00
K.....	43.75
L.....	42.25

If B. B. is omitted deduct \$6.60

No. 4450¹/₂

Cross.....0.8 x 0.2 x 1.0..0.1
 Die.....1.4 x 0.4 x 1.6..0.8
 B. Base....1.8 x 0.8 x 0.8..0.9
 Weight complete 400 lbs.; no B. B. 265 lbs.

C.....	\$31.00
D.....	29.50
F.....	28.50
G.....	28.25
H.....	27.75
I.....	27.50
K.....	27.00
L.....	26.25

If B. B. is omitted deduct \$2.80

No. 4449¹/₄

Die.....1.2 x 0.4 x 1.6..0.7
 B. Base....1.6 x 0.8 x 0.8..0.8
 Weight complete 200 lbs.; no B. B. 80 lbs.

C.....	\$15.25
D.....	14.00
F.....	13.50
G.....	13.25
H.....	12.75
I.....	12.50
K.....	12.25
L.....	11.75

If B. B. is omitted deduct \$2.50

No. 4453

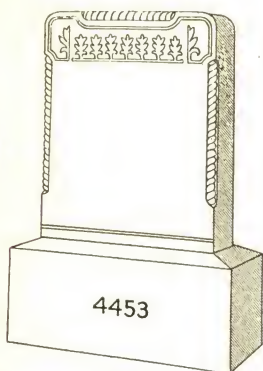

Die.....2.2 x 0.10 x 2.6 .4.6
 B. Base.....2.8 x 1. 4 x 1.0 .3.7
 Weight complete 1450 lbs.; no B. B. 805 lbs.

- C.....\$88.00
- D.....78.00
- F.....73.50
- G.....71.00
- H.....69.00
- I.....66.50
- K.....63.00
- L.....60.00

If B. B. is omitted deduct \$12.55

No. 4453¹/₄

Die.....1.10 x 0.8 x 2.2 .2.8
 B. Base.....2. 4 x 1.2 x 1.0 .2.9
 Weight complete 975 lbs.; no B. B. 480 lbs.

- C.....\$55.50
- D.....49.50
- F.....47.00
- G.....45.75
- H.....44.25
- I.....43.00
- K.....41.00
- L.....39.00

If B. B. is omitted deduct \$9.90

No. 4453¹/₂

Die.....1.6 x 0.6 x 2. 0 .1.6
 B. Base.....2.0 x 1.0 x 0.10 .1.8
 Weight complete 575 lbs.; no B. B. 275 lbs.

- C.....\$36.00
- D.....32.50
- F.....31.00
- G.....30.25
- H.....29.50
- I.....28.75
- K.....27.50
- L.....26.50

If B. B. is omitted deduct \$6.00

No. 4455

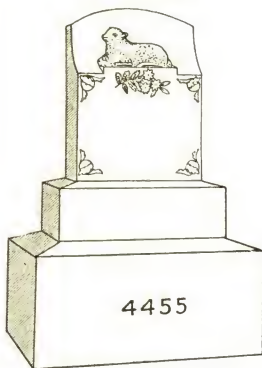

Die.....1.4 x 0. 8 x 1. 8 .1.6
 Base.....1.7 x 0.11 x 0. 5 .0.7
 B. Base.....2.0 x 1. 4 x 0.10 .2.3
 Weight complete 750 lbs.; no B. B. 345 lbs.

- C.....\$50.50
- D.....45.75
- F.....43.75
- G.....42.75
- H.....41.50
- I.....40.50
- K.....39.00
- L.....37.50

If B. B. is omitted deduct \$8.10

No. 4455¹/₄

Die.....1.2 x 0.6 x 1.6 .0.11
 Base.....1.5 x 0.9 x 0.5 .0. 5
 B. Base.....1.9 x 1.1 x 0.8 .1. 3
 Weight complete 450 lbs.; no B. B. 225 lbs.

- C.....\$36.75
- D.....33.75
- F.....32.25
- G.....31.75
- H.....31.00
- I.....30.25
- K.....29.25
- L.....28.25

If B. B. is omitted deduct \$4.50

No. 4455¹/₂

Die.....1.0 x 0.6 x 1.4 .0.8
 Base.....1.2 x 0.8 x 0.4 .0.3
 B. Base.....1.6 x 1.0 x 0.8 .1.0
 Weight complete 325 lbs.; no B. B. 145 lbs.

- C.....\$29.00
- D.....27.00
- F.....26.00
- G.....25.50
- H.....25.00
- I.....24.75
- K.....24.00
- L.....23.25

If B. B. is omitted deduct \$3.75

No. 4460

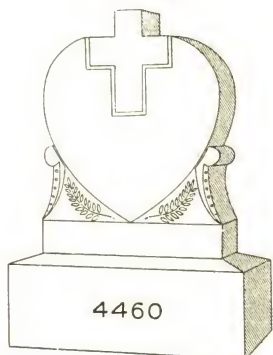

Die.....1.2 x 0. 6 x 1.6. .0.11
 B. Base.....1.6 x 0.10 x 0.8. .0.10
 Weight complete 300 lbs.; no B. B. 150 lbs.

C.....	\$22.50
D.....	20.50
F.....	19.50
G.....	19.00
H.....	18.50
I.....	18.25
K.....	17.50
L.....	16.75

If B. B. is omitted deduct \$3.15

No. 4460¹/₄

Die.....1.2 x 0.4 x 1.6. .0.7
 B. Base.....1.6 x 0.8 x 0.8. .0.8
 Weight complete 225 lbs.; no B. B. 105 lbs.

C.....	\$17.50
D.....	16.25
F.....	15.75
G.....	15.50
H.....	15.00
I.....	14.75
K.....	14.50
L.....	14.00

If B. B. is omitted deduct \$2.50

No. 4460¹/₂

Die.....1.0 x 0.4 x 1.4. .0.5
 B. Base.....1.4 x 0.8 x 0.8. .0.7
 Weight complete 175 lbs.; no B. B. 70 lbs.

C.....	\$14.25
D.....	13.25
F.....	13.00
G.....	12.75
H.....	12.50
I.....	12.25
K.....	11.75
L.....	11.50

If B. B. is omitted deduct \$2.20

No. 4461

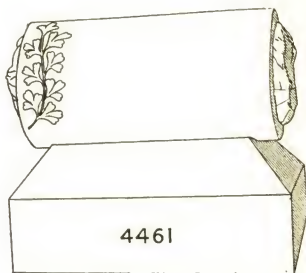

Roll.....2.0 x 1.0 x 1.0. .2.0
 Solid.....1.10 long
 B. Base.....2.0 x 1.2 x 1.0. .2.4

Weight complete 700 lbs.

C.....	\$44.50
D.....	40.00
F.....	38.00
G.....	37.00
H.....	36.00
I.....	35.00
K.....	33.50
L.....	32.00

No. 4461¹/₄

Roll.....1.10 x 0.10 x 0.10. .1.3
 Solid.....1.8 long
 B. Base.....1.10 x 1. 0 x 0.10. .1.6

Weight complete 450 lbs.

C.....	\$31.00
D.....	28.25
F.....	26.75
G.....	26.25
H.....	25.50
I.....	25.00
K.....	24.00
L.....	23.00

No. 4461¹/₂

Roll.....1.8 x 0. 8 x 0.8. .0. 9
 Solid.....1.6 long
 B. Base.....1.8 x 0.10 x 0.8. .0.11

Weight complete 275 lbs.

C.....	\$21.25
D.....	19.75
F.....	18.75
G.....	18.50
H.....	18.00
I.....	17.75
K.....	17.25
L.....	16.50

No. 4462

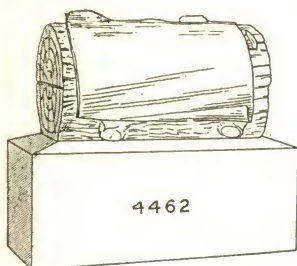

Die.....1.8 x 1.0 x 1.0...1.8
 B. Base.....2.0 x 1.0 x 0.10...1.8
 Weight complete 550 lbs.; no B. B. 250 lbs.
 C.....\$41.00
 D.....37.25
 F.....35.75
 G.....34.75
 H.....34.00
 I.....33.25
 K.....32.00
 L.....30.75
 If B. B. is omitted deduct \$6.00

No. 4462¹/₄

Die.....1.4 x 0.10 x 0.10...0.11
 B. Base.....1.8 x 0.10 x 0.10...1.2
 Weight complete 325 lbs.; no B. B. 115 lbs.
 C.....\$27.25
 D.....25.25
 F.....24.25
 G.....23.75
 H.....23.25
 I.....23.00
 K.....22.25
 L.....21.50
 If B. B. is omitted deduct \$4.20

No. 4462¹/₂

Die.....1.2 x 0.8 x 0.8...0.6
 B. Base.....1.6 x 0.8 x 0.8...0.8
 Weight complete 200 lbs.; no B. B. 80 lbs.
 C.....\$18.75
 D.....17.50
 F.....17.00
 G.....16.75
 H.....16.50
 I.....16.25
 K.....15.75
 L.....15.50
 If B. B. is omitted deduct \$2.50

No. 4466

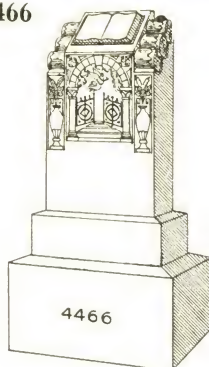

Die.....1.8 x 1.0 x 2.10...4.9
 Base.....2.0 x 1.4 x 0.8...1.9
 B. Base.....2.6 x 1.10 x 1.52...5.4
 Weight complete 2000 lbs.; no B. B. 1040 lbs.
 G.....\$113.00
 H.....109.00
 I.....106.00
 K.....101.00
 L.....96.50
 If B. B. is omitted deduct \$18.65

No. 4466¹/₄

Die.....1.8 x 0.10 x 2.10...3.11
 Base.....2.0 x 1.2 x 0.8...1.7
 B. Base.....2.6 x 1.8 x 1.2...4.10
 Weight complete 1750 lbs.; no B. B. 880 lbs.
 G.....\$96.50
 H.....94.00
 I.....91.00
 K.....87.00
 L.....83.00
 If B. B. is omitted deduct \$16.90

No. 4466¹/₂

Die.....1.6 x 0.10 x 2.8...3.4
 Base.....1.10 x 1.2 x 0.8...1.5
 B. Base.....2.4 x 1.8 x 1.2...4.6
 Weight complete 1550 lbs.; no B. B. 740 lbs.
 D.....\$92.00
 G.....85.00
 H.....82.50
 I.....80.00
 K.....76.50
 L.....73.00
 If B. B. is omitted deduct \$15.75

No. 4466³/₄

Die.....1.4 x 0.8 x 2.6...2.3
 Base.....1.8 x 1.0 x 0.8...1.1
 B. Base.....2.2 x 1.6 x 1.0...3.3
 Weight complete 1100 lbs.; no B. B. 515 lbs.
 D.....\$70.00
 G.....65.00
 H.....63.50
 I.....62.00
 K.....59.50
 L.....57.00
 If B. B. is omitted deduct \$11.40

No. 4467

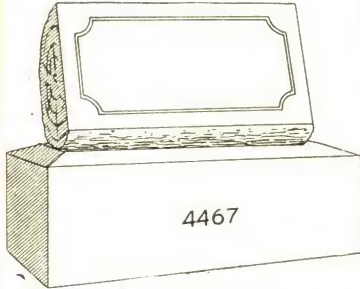

Die.....1.8 x 0.8 x 1.2 . 1.4
 B. Base.....2.0 x 1.0 x 0.10 . 1.8
 Weight complete 450 lbs.; no B. B. 150 lbs.

- C.....\$29.75
- D.....26.75
- F.....25.25
- G.....24.75
- H.....24.00
- I.....23.25
- K.....22.25
- L.....21.25

If B. B. is omitted deduct \$6.00

No. 4468

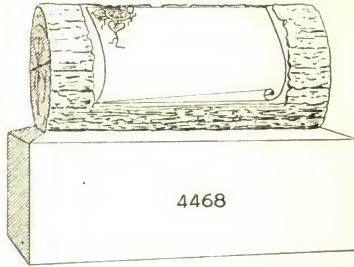

Die.....1.10 x 1.0 x 1.0 . 1.10
 B. Base.....2.2 x 1.0 x 1.0 . 2.2
 Weight complete 600 lbs.; no B. B. 210 lbs.

- C.....\$41.50
- D.....37.50
- F.....35.50
- G.....34.75
- H.....33.75
- I.....32.75
- K.....31.50
- L.....30.00

If B. B. is omitted deduct \$7.80

No. 4467¹/₄

Die.....1.6 x 0.7 x 1.0 . 0.11
 B. Base.....1.10 x 0.11 x 0.10 . 1.5
 Weight complete 350 lbs.; no B. B. 100 lbs.

- C.....\$22.00
- D.....20.00
- F.....19.00
- G.....18.50
- H.....18.00
- I.....17.75
- K.....17.00
- L.....16.25

If B. B. is omitted deduct \$5.10

No. 4468¹/₄

Die.....1.8 x 0.10 x 0.10 . 1.2
 B. Base.....2.0 x 0.10 x 0.10 . 1.5
 Weight complete 375 lbs.; no B. B. 120 lbs.

- C.....\$28.00
- D.....25.25
- F.....24.25
- G.....23.50
- H.....23.00
- I.....22.50
- K.....21.50
- L.....20.75

If B. B. is omitted deduct \$5.10

No. 4467¹/₂

Die.....1.4 x 0.6 x 0.10 . 0.7
 B. Base.....1.8 x 0.10 x 0.8 . 0.11
 Weight complete 225 lbs.; no B. B. 60 lbs.

- C.....\$15.00
- D.....13.75
- F.....13.25
- G.....13.00
- H.....12.50
- I.....12.25
- K.....12.00
- L.....11.50

If B. B. is omitted deduct \$3.45

No. 4468¹/₂

Die.....1.6 x 0.8 x 0.8 . 0.8
 B. Base.....1.10 x 0.8 x 0.8 . 0.10
 Weight complete 225 lbs.; no B. B. 75 lbs.

- C.....\$18.75
- D.....17.25
- F.....16.75
- G.....16.25
- H.....16.00
- I.....15.75
- K.....15.25
- L.....14.75

If B. B. is omitted deduct \$3.15

No. 4470

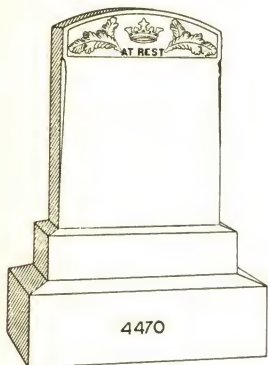

Die.....1.6 x 0.6 x 2. 0..1.6
 Base.....1.9 x 0.9 x 0. 5..0.7
 B. Base.....2.2 x 1.2 x 0.10..2.1
 Weight complete 725 lbs.; no B. B. 350 lbs.

C.....\$44.50
 D.....39.75
 F.....37.75
 G.....36.75
 H.....35.50
 I.....34.50
 K.....33.00
 L.....31.50
 If B. B. is omitted deduct \$7.50

No. 4474

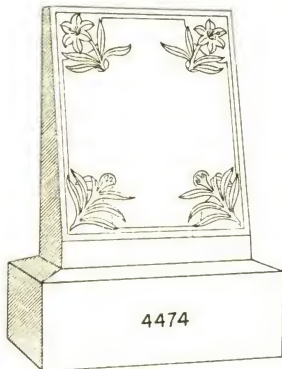

Die.....1. 6 x 0.8 x 1.10..1.10
 B. Base....1.10 x 1.0 x 0.10..1. 6
 Weight complete 550 lbs.; no B. B. 280 lbs.

C.....\$35.50
 D.....31.50
 F.....29.50
 G.....28.75
 H.....27.75
 I.....26.75
 K.....25.50
 L.....24.00
 If B. B. is omitted deduct \$5.40

No. 4474¹/₄

Die.....1.4 x 0. 6 x 1.8..1. 1
 B. Base....1.8 x 0.10 x 0.8..0.11
 Weight complete 325 lbs.; no B. B. 160 lbs.

C.....\$21.25
 D.....18.75
 F.....17.75
 G.....17.25
 H.....16.50
 I.....16.00
 K.....15.25
 L.....14.50
 If B. B. is omitted deduct \$3.45

No. 4470¹/₄

Die.....1.6 x 0.4 x 2. 0..1. 0
 Base.....1.9 x 0.7 x 0. 4..0. 4
 B. Base....2.2 x 1.0 x 0.10..1.10
 Weight complete 550 lbs.; no B. B. 220 lbs.

C.....\$33.25
 D.....30.25
 F.....28.75
 G.....28.25
 H.....27.50
 I.....26.75
 K.....25.75
 L.....24.75
 If B. B. is omitted deduct \$6.60

No. 4474¹/₂

Die.....1.2 x 0. 6 x 1.6..0.11
 B. Base....1.6 x 0.10 x 0.8..0.10
 Weight complete 275 lbs.; no B. B. 125 lbs.

C.....\$19.00
 D.....17.00
 F.....16.00
 G.....15.50
 H.....15.00
 I.....14.75
 K.....14.00
 L.....13.25
 If B. B. is omitted deduct \$3.15

No. 4475

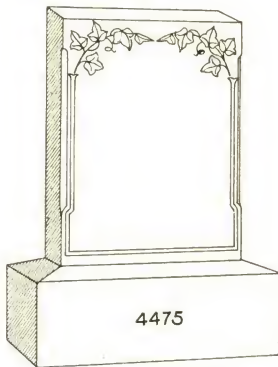

Die.....1.6 x 0.6 x 2. 0..1.6
 B. Base.....2.0 x 1.0 x 0.10..1.8
 Weight complete 550 lbs.; no B. B. 250 lbs.

- G.....\$27.75
- H.....27.00
- I.....26.25
- K.....25.00
- L.....24.00

If B. B. is omitted deduct \$6.00

No. 4475¹/₄

Die.....1.6 x 0. 4 x 2. 0..1.0
 B. Base.....2.0 x 0.10 x 0.10..1.5
 Weight complete 425 lbs.; no B. B. 170 lbs.

- G.....\$21.25
- H.....20.75
- I.....20.25
- K.....19.50
- L.....18.75

If B. B. is omitted deduct \$5.10

No. 4475¹/₂

Die.....1.4 x 0. 6 x 1. 8..1.1
 B. Base.....1.8 x 0.10 x 0.10..1.2
 Weight complete 400 lbs.; no B. B. 190 lbs.

- G.....\$21.00
- H.....20.25
- I.....19.75
- K.....19.00
- L.....18.25

If B. B. is omitted deduct \$4.20

No. 4475³/₄

Die.....1.4 x 0.4 x 1.8..0.9
 B. Base.....1.8 x 0.8 x 0.8..0.9
 Weight complete 250 lbs.; no B. B. 115 lbs.

- G.....\$15.00
- H.....14.50
- I.....14.25
- K.....13.75
- L.....13.00

If B. B. is omitted deduct \$2.80

No. 4478

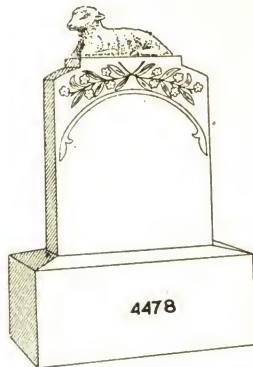

Die.....1.2 x 0. 6 x 1. 8..1.0
 B. Base.....1.6 x 0.10 x 0.10..1.1
 Weight complete 350 lbs.; no B. B. 155 lbs.

- G.....\$28.75
- H.....28.25
- I.....27.75
- K.....27.00
- L.....26.25

If B. B. is omitted deduct \$3.90

No. 4478¹/₄

Die.....1.0 x 0. 6 x 1.6..0.9
 B. Base.....1.4 x 0.10 x 0.8..0.9
 Weight complete 250 lbs.; no B. B. 115 lbs.

- G.....\$23.25
- H.....22.75
- I.....22.50
- K.....22.00
- L.....21.25

If B. B. is omitted deduct \$2.80

No. 4478¹/₂

Die.....1.2 x 0.4 x 1.8..0.8
 B. Base.....1.6 x 0.8 x 0.8..0.8
 Weight complete 225 lbs.; no B. B. 105 lbs.

- G.....\$21.25
- H.....21.00
- I.....20.75
- K.....20.25
- L.....19.75

If B. B. is omitted deduct \$2.50

No. 4478³/₄

Die.....1.0 x 0.4 x 1.6..0.6
 B. Base.....1.4 x 0.8 x 0.8..0.7
 Weight complete 175 lbs.; no B. B. 70 lbs.

- G.....\$20.00
- H.....19.75
- I.....19.50
- K.....19.00
- L.....18.75

If B. B. is omitted deduct \$2.20

No. 4479

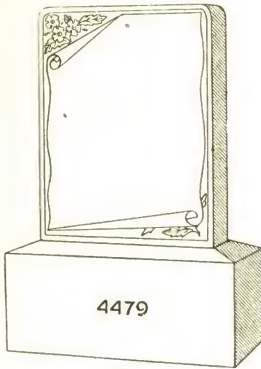

Die.....1.2 x 0.4 x 1.6 .0.7
 B. Base.....1.6 x 0.8 x 0.8 .0.8

Weight complete 225 lbs.; no B. B. 105 lbs.

C.....	\$14.75
D.....	13.50
F.....	13.00
G.....	12.75
H.....	12.25
I.....	12.00
K.....	11.75
L.....	11.25

If B. B. is omitted deduct \$2.50

No. 4480

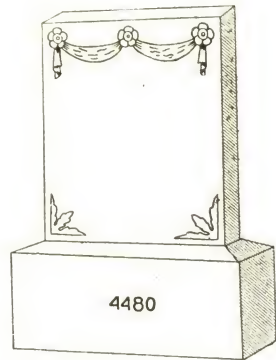

Die.....1.2 x 0.4 x 1.6 .0.7
 B. Base.....1.6 x 0.8 x 0.8 .0.8

Weight complete 225 lbs.; no B. B. 105 lbs.

C.....	\$14.75
D.....	13.50
F.....	13.00
G.....	12.75
H.....	12.25
I.....	12.00
K.....	11.75
L.....	11.25

If B. B. is omitted deduct \$2.50

No. 4479¹/₄

Die.....1.0 x 0.4 x 1.4 .0.5
 B. Base.....1.4 x 0.8 x 0.8 .0.7

Weight complete 180 lbs.; no B. B. 75 lbs.

C.....	\$12.50
D.....	11.50
F.....	11.00
G.....	10.75
H.....	10.50
I.....	10.25
K.....	10.00
L.....	9.75

If B. B. is omitted deduct \$2.20

No. 4480¹/₄

Die.....1.0 x 0.4 x 1.4 .0.5
 B. Base.....1.4 x 0.8 x 0.8 .0.7

Weight complete 180 lbs.; no B. B. 75 lbs.

C.....	\$12.50
D.....	11.50
F.....	11.00
G.....	10.75
H.....	10.50
I.....	10.25
K.....	10.00
L.....	9.75

If B. B. is omitted deduct \$2.20

No. 4484

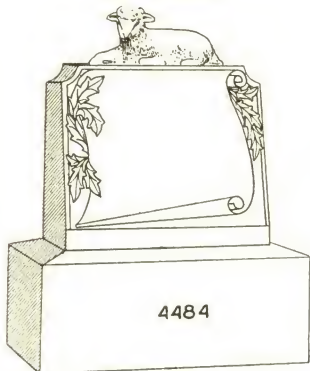

4484

Die.....1.4 x 0.8 x 1. 6..1.4
 B. Base.....1.8 x 1.0 x 0.10..1.5
 Weight complete 475 lbs.; no B. B. 220 lbs.
 G.....\$39.00
 H.....38.25
 I.....37.50
 K.....36.50
 L.....35.50
 If B. B. is omitted deduct \$5.10

No. 4484 1/4

Die.....1.2 x 0. 6 x 1.4..0. 9
 B. Base.....1.6 x 0.10 x 0.8..0.10
 Weight complete 275 lbs.; no B. B. 125 lbs.
 G.....\$26.25
 H.....25.75
 I.....25.50
 K.....25.00
 L.....24.25
 If B. B. is omitted deduct \$3.15

No. 4485

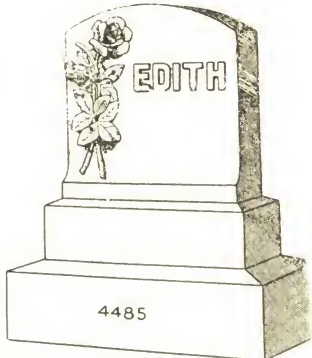

4485

Die.....1.0 x 0.5 x 1.2..0.6
 Base.....1.3 x 0.8 x 0.4..0.3
 B. Base.....1.7 x 1.0 x 0.8..1.1
 Weight complete 300 lbs.; no B. B. 105 lbs.
 G...\$41.25 K...\$40.00
 H... 40.75 L... 39.25
 I... 40.50
 If B. B. is omitted deduct \$3.90

No. 4489

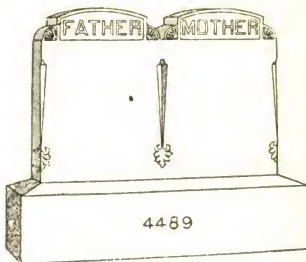

4489

Die.....2.8 x 0.6 x 1.10..2.5
 B. Base.....3.2 x 1.0 x 0.10..2.8
 Weight complete 900 lbs.; no B. B. 420 lbs.

C.....\$52.50
 D.....47.00
 F.....44.50
 G.....43.25
 H.....42.00
 I.....41.00
 K.....39.00
 L.....37.25

If B. B. is omitted deduct \$9.60
 Lettering not included

No. 4489 1/4

Die.....2.8 x 0. 4 x 1.10..1.8
 B. Base.....3.2 x 0.10 x 0.10..2.2
 Weight complete 675 lbs.; no B. B. 285 lbs.

C.....\$41.00
 D.....37.25
 F.....35.75
 G.....34.75
 H.....34.00
 I.....33.25
 K.....32.00
 L.....30.75

If B. B. is omitted deduct \$7.80
 Lettering not included

No. 4496

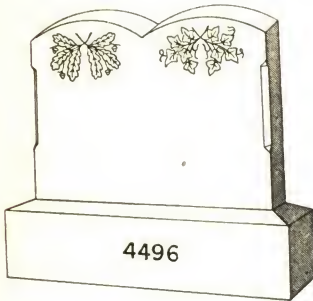

Die.....2.8 x 0.6 x 2. 0..2.8
 B. Base.....3.2 x 1.0 x 0.10..2.8
 Weight complete 925 lbs.; no B. B. 445 lbs.

- C.....\$54.50
- D.....48.25
- F.....45.75
- G.....44.25
- H.....43.00
- I.....41.75
- K.....39.75
- L.....37.75

If B. B. is omitted deduct \$9.60

No. 4497

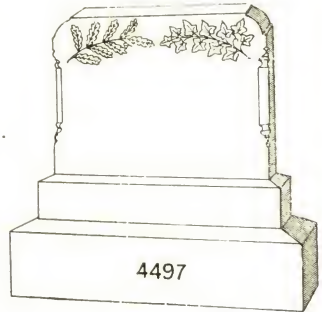

Die.....2. 8 x 0.6 x 2. 0..2.8
 Base.....2.11 x 0.9 x 0. 6..1.1
 B. Base....3. 4 x 1.2 x 0.10..3.3
 Weight complete 1200 lbs.; no B. B. 615 lbs.

- C.....\$73.00
- D.....64.50
- F.....60.50
- G.....59.00
- H.....57.00
- I.....55.00
- K.....52.00
- L.....49.25

If B. B. is omitted deduct \$11.40

No. 4496¹/₄

Die.....2.8 x 0. 4 x 2. 0..1.9
 B. Base....3.2 x 0.10 x 0.10..2.2
 Weight complete 675 lbs.; no B. B. 285 lbs.

- C.....\$38.75
- D.....35.00
- F.....33.25
- G.....32.25
- H.....31.25
- I.....30.50
- K.....29.25
- L.....27.75

If B. B. is omitted deduct \$7.80

No. 4497¹/₄

Die.....2. 8 x 0.4 x 2. 0..1.9
 Base.....2.11 x 0.7 x 0. 5..0.9
 B. Base....3. 4 x 1.0 x 0.10..2.9
 Weight complete 900 lbs.; no B. B. 405 lbs.

- C.....\$54.00
- D.....48.25
- F.....45.75
- G.....44.50
- H.....43.25
- I.....42.00
- K.....40.25
- L.....38.25

If B. B. is omitted deduct \$9.90

No. 4498



Die.....2. 8 x 0.6 x 2. 0. .2.8
 Base.....2. 11 x 0.9 x 0. 6. .1.1
 B. Base....3. 4 x 1.2 x 0.10. .3.3

Weight complete 1200 lbs.; no B. B. 615 lbs.

C.....	\$70.50
D.....	62.00
F.....	58.00
G.....	56.50
H.....	54.50
I.....	52.50
K.....	49.75
L.....	46.75

If B. B. is omitted deduct \$11.40

No. 4501

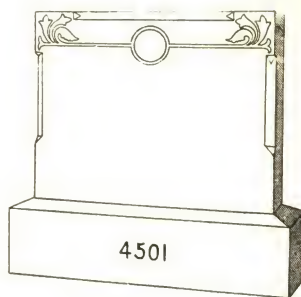

Die.....3.0 x 0.8 x 2. 0. .4.0
 B. Base....3.6 x 1.2 x 0.10. .3.5

Weight complete 1300 lbs.; no B. B. 685 lbs.

C.....	\$73.50
D.....	64.50
F.....	60.50
G.....	58.50
H.....	56.50
I.....	54.50
K.....	51.50
L.....	48.50

If B. B. is omitted deduct \$11.95

No. 4501¹/₄

Die.....2.8 x 0.6 x 1.10. .2.5
 B. Base....3.2 x 1.0 x 0.10. .2.8

Weight complete 900 lbs.; no B. B. 420 lbs.

C.....	\$47.75
D.....	42.25
F.....	39.75
G.....	38.50
H.....	37.25
I.....	36.25
K.....	34.25
L.....	32.50

If B. B. is omitted deduct \$9.60

No. 4498¹/₄

Die.....2. 8 x 0.4 x 2. 0. .1.9
 Base.....2. 11 x 0.7 x 0. 5. .0.9
 B. Base....3. 4 x 1.0 x 0.10. .2.9

Weight complete 900 lbs.; no B. B. 405 lbs.

C.....	\$52.50
D.....	47.00
F.....	44.50
G.....	43.25
H.....	42.00
I.....	40.75
K.....	38.75
L.....	37.00

If B. B. is omitted deduct \$9.90

No. 4501¹/₂

Die.....2.8 x 0. 4 x 1.10. .1.8
 B. Base....3.2 x 0.10 x 0.10. .2.2

Weight complete 675 lbs.; no B. B. 285 lbs.

C.....	\$36.25
D.....	32.50
F.....	31.00
G.....	30.00
H.....	29.25
I.....	28.50
K.....	27.25
L.....	26.00

If B. B. is omitted deduct \$7.80

No. 4504

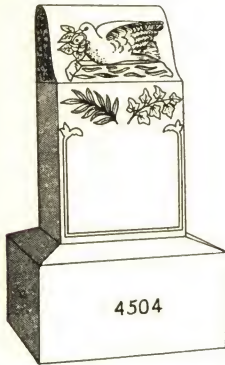

Die.....1. 4 x 0.10 x 2.2..2.5
 B. Base.....1.10 x 1. 4 x 1.0..2.5
 Weight complete 850 lbs.; no B. B. 415 lbs.

- C.....\$66.00
 - D.....60.50
 - F.....58.50
 - G.....57.00
 - H.....56.00
 - I.....54.50
 - K.....53.00
 - L.....51.00
- If B. B. is omitted deduct \$8.70

No. 4508

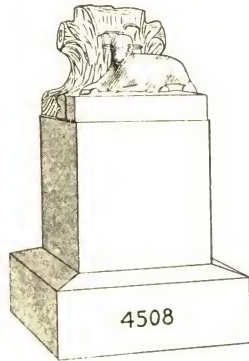

Die.....0.10 x 0.10 x 1.6..1.1
 B. Base.....1. 2 x 1. 2 x 0.6..0.8
 Weight complete 300 lbs.; no B. B. 180 lbs.

- C.....\$36.25
 - D.....33.75
 - F.....32.75
 - G.....32.25
 - H.....31.50
 - I.....31.00
 - K.....30.25
 - L.....29.50
- If B. B. is omitted deduct \$2.50

No. 4504¹/₄

Die.....1.2 x 0.8 x 2. 0..1.7
 B. Base.....1.8 x 1.2 x 0.10..1.7
 Weight complete 550 lbs.; no B. B. 265 lbs.

- C.....\$49.25
 - D.....45.75
 - F.....44.25
 - G.....43.50
 - H.....42.50
 - I.....41.75
 - K.....40.75
 - L.....39.50
- If B. B. is omitted deduct \$5.70

No. 4504¹/₂
 see next column

No. 4504¹/₂

Die.....1.0 x 0.8 x 1.10..1.3
 B. Base.....1.6 x 1.2 x 0.10..1.6
 Weight complete 475 lbs.; no B. B. 200 lbs.

- C.....\$40.25
 - D.....37.50
 - F.....36.00
 - G.....35.50
 - H.....35.00
 - I.....34.25
 - K.....33.25
 - L.....32.25
- If B. B. is omitted deduct \$5.40

No. 4509

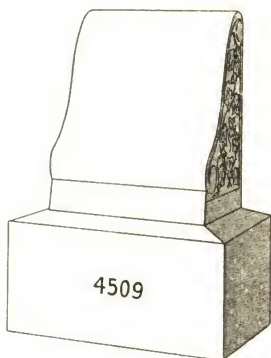

Die.....1.2 x 0.8 x 1.4..1.0
 B. Base.....1.6 x 1.0 x 0.8..1.0

Weight complete 325 lbs.; no B. B. 145 lbs.

C.....	\$25.25
D.....	23.00
F.....	22.00
G.....	21.50
H.....	21.00
I.....	20.50
K.....	19.75
L.....	19.00

If B. B. is omitted deduct \$3.75

No. 4510

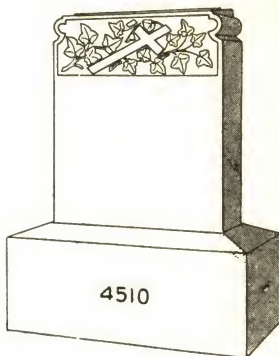

Die.....1.4 x 0.6 x 1.8..1.1
 B. Base.....1.8 x 0.10 x 0.10..1.2

Weight complete 400 lbs.; no B. B. 190 lbs.

C.....	\$26.00
D.....	23.50
F.....	22.50
G.....	22.00
H.....	21.25
I.....	20.75
K.....	20.00
L.....	19.25

If B. B. is omitted deduct \$4.20

No. 4509¹/₄

Die.....1.0 x 0.8 x 1.2..0.9
 B. Base.....1.4 x 1.0 x 0.8..0.11

Weight complete 275 lbs.; no B. B. 110 lbs.

C.....	\$20.25
D.....	18.75
F.....	17.75
G.....	17.50
H.....	17.00
I.....	16.75
K.....	16.25
L.....	15.50

If B. B. is omitted deduct \$3.45

No. 4510¹/₄

Die.....1.2 x 0.4 x 1.6..0.7
 B. Base.....1.6 x 0.8 x 0.8..0.8

Weight complete 225 lbs.; no B. B. 105 lbs.

C.....	\$15.75
D.....	14.50
F.....	14.00
G.....	13.75
H.....	13.25
I.....	13.00
K.....	12.75
L.....	12.25

If B. B. is omitted deduct \$2.50

No. 4513

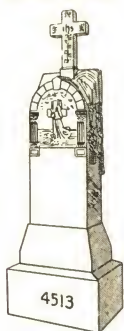

Cross.....1. 0 x 0. 4 x 1. 8..0. 7
 Die.....1. 7 x 0.10 x 3. 6..4. 7
 Base.....1.11 x 1. 3 x 0.10..2. 0
 B. Base...2. 5 x 1. 9 x 1. 2..4. 11
 Weight complete 2100 lbs.; no B. B. 1215 lbs.

C.....	\$177.00
D.....	161.00
F.....	153.00
G.....	150.00
H.....	146.00
I.....	143.00
K.....	137.00
L.....	132.00

If B. B. is omitted deduct \$17.20

No. 4513¹/₄

Cross.....1.0 x 0. 4 x 1. 6..0. 6
 Die.....1.5 x 0.10 x 3. 0..3. 7
 Base.....1.9 x 1. 3 x 0.10..1.10
 B. Base...2.3 x 1. 9 x 1. 0..3. 11
 Weight complete 1700 lbs.; no B. B. 995 lbs.

C.....	\$145.00
D.....	132.00
F.....	126.00
G.....	123.00
H.....	120.00
I.....	117.00
K.....	113.00
L.....	108.00

If B. B. is omitted deduct \$13.70

No. 4513¹/₂

Cross.....0.10 x 0.3 x 1.3..0.3
 Die.....1. 3 x 0.8 x 2.8..2.3
 Base.....1. 6 x 1.0 x 0.8..1.0
 B. Base...2. 0 x 1.6 x 1.0..3.0
 Weight complete 1100 lbs.; no B. B. 560 lbs.

C.....	\$107.00
D.....	99.00
F.....	96.00
G.....	94.00
H.....	92.50
I.....	90.50
K.....	88.00
L.....	85.50

If B. B. is omitted deduct \$10.80

No. 4515

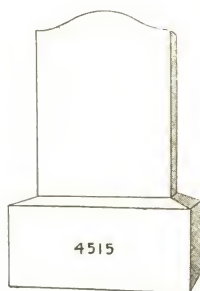

Die.....1.6 x 0.6 x 2. 0..1.6
 B. Base...2.0 x 1.0 x 0.10..1.8
 Weight complete 550 lbs.; no B. B. 250 lbs.

C.....	\$28.25
D.....	24.75
F.....	23.25
G.....	22.50
H.....	21.75
I.....	21.00
K.....	19.75
L.....	18.75

If B. B. is omitted deduct \$6.00
 Face polished, back and edges sand finished.

No. 4515¹/₄

Die.....1.6 x 0. 4 x 2. 0..1.0
 B. Base...2.0 x 0.10 x 0.10..1.5
 Weight complete 400 lbs.; no B. B. 145 lbs.

C.....	\$21.00
D.....	18.75
F.....	17.75
G.....	17.25
H.....	16.75
I.....	16.25
K.....	15.50
L.....	14.75

If B. B. is omitted deduct \$5.10
 Face polished, back and edges sand finished.

No. 4516

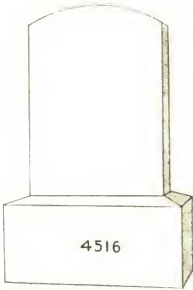

Sizes, prices and finish same as No. 4515.

No. 4516 $\frac{1}{4}$

Sizes, prices and finish same as No. 4515 $\frac{1}{4}$.

No. 4517

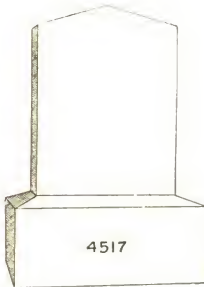

Sizes, prices and finish same as No. 4515.

No. 4517 $\frac{1}{4}$

Sizes, prices and finish same as No. 4515 $\frac{1}{4}$.

No. 4522



Die.....1.2 x 0.6 x 1.6..0.11
B. Base....1.6 x 0.10 x 0.10..1.1

Weight complete 350 lbs.; no B. B. 155 lbs.

C.....	\$29.75
D.....	27.75
F.....	26.75
G.....	26.25
H.....	25.75
I.....	25.50
K.....	24.75
L.....	24.00

If B. B. is omitted deduct \$3.90

No. 4522 $\frac{1}{4}$

Die.....1.0 x 0.4 x 1.4..0.5
B. Base....1.4 x 0.8 x 0.8..0.7

Weight complete 175 lbs.; no B. B. 70 lbs.

C.....	\$20.50
D.....	19.50
F.....	19.25
G.....	19.00
H.....	18.75
I.....	18.50
K.....	18.00
L.....	17.75

If B. B. is omitted deduct \$2.20

No. 4523

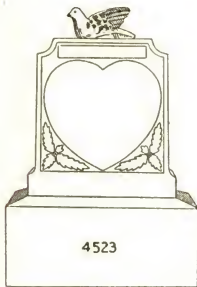

Die.....1.4 x 0.8 x 1. 8..1.6
 B. Base.....1.8 x 1.0 x 0.10..1.5
 Weight complete 500 lbs.; no B. B. 245 lbs.

C.....	\$45.50
D.....	42.00
F.....	40.50
G.....	39.75
H.....	39.00
I.....	38.25
K.....	37.00
L.....	36.00

If B. B. is omitted deduct \$5.10

No. 4524

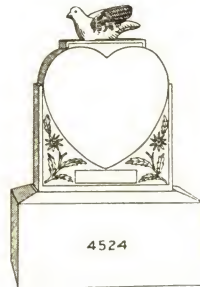

Die.....1.2 x 0. 6 x 1. 6..0.11
 B. Base....1.6 x 0.10 x 0.10..1. 1
 Weight complete 375 lbs.; no B. B. 180 lbs.

C.....	\$34.25
D.....	32.25
F.....	31.25
G.....	30.75
H.....	30.25
I.....	30.00
K.....	29.25
L.....	28.50

If B. B. is omitted deduct \$3.90

No. 4523¹/₄

Die.....1.2 x 0. 6 x 1. 6..0.11
 B. Base....1.6 x 0.10 x 0.10..1. 1
 Weight complete 350 lbs.; no B. B. 155 lbs.

C.....	\$35.50
D.....	33.50
F.....	32.50
G.....	32.00
H.....	31.50
I.....	31.25
K.....	30.50
L.....	29.75

If B. B. is omitted deduct \$3.90

No. 4524¹/₄

Die.....1.0 x 0.4 x 1.4..0.5
 B. Base....1.4 x 0.8 x 0.8..0.7
 Weight complete 180 lbs.; no B. B. 75 lbs.

C.....	\$24.25
D.....	23.25
F.....	23.00
G.....	22.75
H.....	22.50
I.....	22.25
K.....	21.75
L.....	21.50

If B. B. is omitted deduct \$2.20

No. 4525

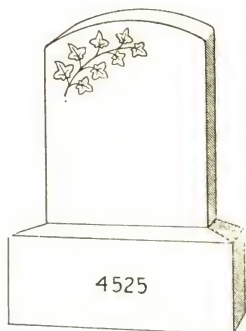

Die.....1.6 x 0.6 x 2. 0. .1.6
 B. Base.....2.0 x 1.0 x 0.10. .1.8

Weight complete 550 lbs.; no B. B. 220 lbs.

C.....	\$30.75
D.....	27.25
F.....	25.75
G.....	25.00
H.....	24.25
I.....	23.50
K.....	22.25
L.....	21.25

If B. B. is omitted deduct \$6.00

Face, edges and top polished; back sand finished. If back is polished add \$1.25.

No. 4525 $\frac{1}{4}$

Die.....1.6 x 0. 4 x 2. 0. .1.0
 B. Base.....2.0 x 0.10 x 0.10. .1.5

Weight complete 425 lbs.; no B. B. 230 lbs.

C.....	\$22.75
D.....	20.50
F.....	19.50
G.....	19.00
H.....	18.50
I.....	18.00
K.....	17.25
L.....	16.50

If B. B. is omitted deduct \$5.10

Face, edges and top polished; back sand finished. If back is polished add \$1.25.

No. 4526

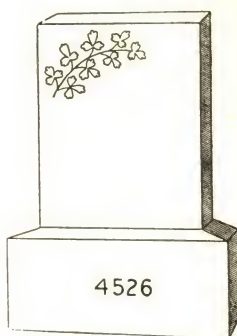

Sizes, prices and finish, same as No. 4525.

No. 4526 $\frac{1}{4}$

Sizes, prices and finish same as No. 4525 $\frac{1}{4}$.

No. 4527

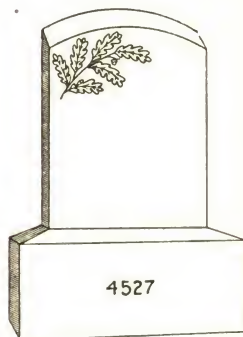

Sizes, prices and finish same as No. 4525.

No. 4527 $\frac{1}{4}$

Sizes, prices and finish same as No. 4525 $\frac{1}{4}$.

No. 4534

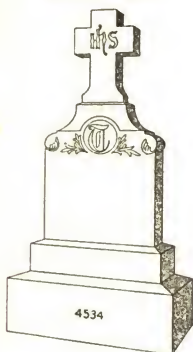

Cross.....	1.2 x 0.5 x 1.8 . . 0.10
Die.....	2.2 x 0.8 x 2.6 . . 3.7
Base.....	2.6 x 1.0 x 0.8 . . 1.8
B. Base.....	3.0 x 1.6 x 1.0 . . 4.6
Weight complete 1800 lbs.; no B. B. 990 lbs.	
C.....	\$123.00
D.....	109.00
F.....	103.00
G.....	100.00
H.....	97.00
I.....	94.00
K.....	89.50
L.....	84.50
If B. B. is omitted deduct \$15.75	

No. 4534¹/₄

Cross.....	1.0 x 0.4 x 1.6 . . 0.6
Die.....	1.10 x 0.6 x 2.2 . . 2.0
Base.....	2.2 x 0.10 x 0.6 . . 0.11
B. Base.....	2.8 x 1.4 x 0.10 . . 3.0
Weight complete 1100 lbs.; no B. B. 555 lbs.	
C.....	\$79.50
D.....	71.50
F.....	68.50
G.....	66.50
H.....	65.00
I.....	63.00
K.....	60.50
L.....	58.00
If B. B. is omitted deduct \$10.80	

No. 4534¹/₂

Cross.....	0.10 x 0.3 x 1.3 . . 0.3
Die.....	1.8 x 0.6 x 2.0 . . 1.8
Base.....	2.0 x 0.10 x 0.6 . . 0.10
B. Base.....	2.6 x 1.4 x 0.10 . . 2.9
Weight complete 950 lbs.; no B. B. 450 lbs.	
C.....	\$67.00
D.....	61.00
F.....	58.00
G.....	57.00
H.....	55.50
I.....	54.00
K.....	52.00
L.....	50.00
If B. B. is omitted deduct \$9.90	

No. 4537



Die.....	1.6 x 0.6 x 2.4 . . 1.9
B. Base.....	2.0 x 1.0 x 0.10 . . 1.8
Weight complete 600 lbs.; no B. B. 300 lbs.	
C.....	\$49.75
D.....	46.00
F.....	44.00
G.....	43.25
H.....	42.25
I.....	41.50
K.....	40.25
L.....	38.75
If B. B. is omitted deduct \$6.00	

No. 4537¹/₄

Die.....	1.4 x 0.4 x 1.10 . . 0.10
B. Base.....	1.10 x 0.10 x 0.10 . . 1.3
Weight complete 350 lbs.; no B. B. 125 lbs.	
C.....	\$31.25
D.....	29.50
F.....	28.50
G.....	28.25
H.....	27.75
I.....	27.25
K.....	26.75
L.....	26.00
If B. B. is omitted deduct \$4.50	

No. 4537¹/₂

Die.....	1.2 x 0.4 x 1.8 . . 0.8
B. Base.....	1.7 x 0.9 x 0.8 . . 0.10
Weight complete 250 lbs.; no B. B. 100 lbs.	
C.....	\$26.00
D.....	24.50
F.....	24.00
G.....	23.50
H.....	23.25
I.....	23.00
K.....	22.50
L.....	22.00
If B. B. is omitted deduct \$3.15	

No. 4538

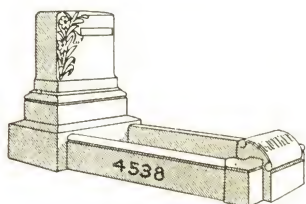

Die.....2. 0 x 0.10 x 1.10..3. 1
 Base.....2. 4 x 1. 2 x 0. 8..1.10
 B. Base...2.10 x 1. 8 x 1. 0..4. 9
 2 Sides...4. 0 x 0. 3 x 0.10..1. 8
 Foot.....2. 4 x 0. 8 x 1. 2..1.10

Weight complete 2300 lbs.

C.....\$180.00
 D.....168.00
 F.....164.00
 G.....161.00
 H.....159.00
 I.....156.00
 K.....142.00
 L.....139.00

Foot and side pieces of \$4.25 stock grit finished.

Price of foot and side pieces, \$46.00

No. 4541



Die.....1. 6 x 0.6 x 2. 4..1. 9
 B. Base...2. 0 x 1.0 x 0.10..1. 8
 2 Sides...4. 0 x 0.2 x 0. 8..0.10
 Foot.....1.10 x 0.3 x 0.10..0. 5

Weight complete 800 lbs.

C.....\$70.50
 D.....63.50
 F.....60.50
 G.....59.00
 H.....57.50
 I.....56.00
 K.....54.00
 L.....51.50

Foot and side pieces of \$4.25 stock sand finished.

Price of foot and side pieces, \$17.25

No. 4541¹/₄

Die.....1. 4 x 0. 4 x 1.10..0.10
 B. Base...1.10 x 0.10 x 0.10..1. 3
 2 Sides...3. 0 x 0. 2 x 0. 6..0. 6
 Foot.....1. 8 x 0. 2 x 0. 8..0. 2

Weight complete 450 lbs.

C.....\$46.00
 D.....42.50
 F.....41.00
 G.....40.25
 H.....39.50
 I.....38.75
 K.....37.50
 L.....36.50

Foot and side pieces of \$4.25 stock sand finished.

Price of foot and side pieces, \$10.75.

No. 4538¹/₄

Die.....2. 0 x 0.8 x 1.10..2. 5
 Base.....2. 4 x 1.0 x 0. 6..1. 2
 B. Base...2.10 x 1.6 x 1. 0..4. 3
 2 Sides...4. 0 x 0.3 x 0.10..1. 8
 Foot.....2. 4 x 0.8 x 1. 2..1.10

Weight complete 2000 lbs.

C.....\$160.00
 D.....152.00
 F.....148.00
 G.....146.00
 H.....145.00
 I.....143.00
 K.....140.00
 L.....137.00

Foot and side pieces of \$4.25 stock grit finished.

Price of foot and side pieces, \$46.00

No. 4541¹/₂

Die.....1.2 x 0.4 x 1.8..0. 8
 B. Base...1.7 x 0.9 x 0.8..0.10
 2 Sides...2.4 x 0.2 x 0.6..0. 4
 Foot.....1.6 x 0.2 x 0.8..0. 2

Weight complete 325 lbs.

C.....\$37.25
 D.....34.50
 F.....33.50
 G.....32.75
 H.....32.25
 I.....31.75
 K.....30.75
 L.....30.00

Foot and side pieces of \$4.25 stock sand finished.

Price of foot and side pieces, \$9.00.

No. 4542

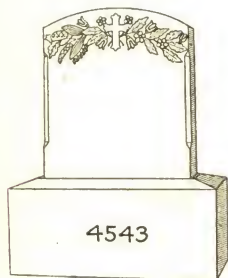

Figure.....1. 2 x 1. 2 x 2.5. .3.3
 Die.....1. 4 x 1. 4 x 2.6. .4.5
 B. Base.....1.10 x 1.10 x 1.0. .3.4
 Weight complete 1500 lbs.; no B. B. 900 lbs.

C.....	\$290.00
D.....	273.00
F.....	265.00
G.....	261.00
H.....	258.00
I.....	254.00
K.....	246.00
L.....	242.00

If B. B. is omitted deduct \$11.65
 Price of figure alone \$190.00

No. 4543



Die.....1.2 x 0.4 x 1.4. .0.6
 B. Base.....1.6 x 0.8 x 0.8. .0.8
 Weight complete 200 lbs.; no B. B. 80 lbs.

C.....	\$13.50
D.....	12.25
F.....	11.75
G.....	11.50
H.....	11.25
I.....	11.00
K.....	10.50
L.....	10.25

If B. B. is omitted deduct \$2.50

No. 4543¹/₄

See next column.

No. 4544



Sizes and prices same as No. 4543.

No. 4544¹/₄

Sizes and prices same as No. 4543¹/₄.

No. 4545

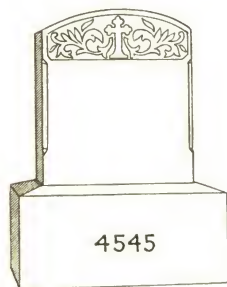

Sizes and prices same as No. 4543.

No. 4545¹/₄

Sizes and prices same as No. 4543¹/₄.

No. 4543¹/₄

Die.....1.0 x 0.4 x 1.2. .0.5
 B. Base.....1.4 x 0.8 x 0.8. .0.7
 Weight complete 175 lbs.; no B. B. 70 lbs.

C.....	\$11.50
D.....	10.50
F.....	10.25
G.....	10.00
H.....	9.75
I.....	9.50
K.....	9.00
L.....	8.75

If B. B. is omitted deduct \$2.20

No. 4549

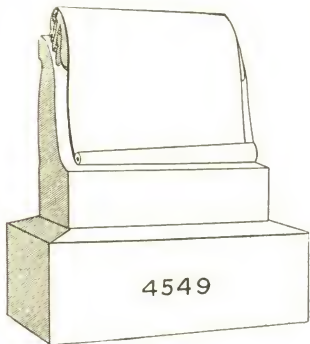

Die.....1.8 x 0.10 x 1.8..2.4
 B. Base.....2.0 x 1.2 x 1.0..2.4
 Weight complete 700 lbs.; no B. B. 280 lbs.

- C.....\$67.00
- D.....61.50
- F.....59.50
- G.....58.00
- H.....57.00
- I.....56.00
- K.....54.00
- L.....52.50

If B. B. is omitted deduct \$8.40

No. 4551

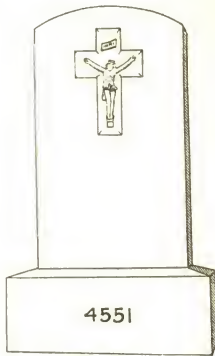

Die.....1.6 x 0.6 x 2.6..1.11
 B. Base.....2.0 x 1.0 x 0.10..1.8
 Weight complete 625 lbs.; no B. B. 325 lbs.

- C.....\$50.50
- D.....46.00
- F.....44.00
- G.....43.00
- H.....42.00
- I.....41.25
- K.....39.75
- L.....38.25

If B. B. is omitted deduct \$6.00

Face and edges polished; back sand finished.

No. 4551 $\frac{1}{4}$

Die.....1.6 x 0.4 x 2.6..1.3
 B. Base.....2.0 x 0.10 x 0.10..1.5
 Weight complete 475 lbs.; no B. B. 220 lbs.

- C.....\$39.00
- D.....36.25
- F.....34.75
- G.....34.25
- H.....33.50
- I.....33.00
- K.....32.00
- L.....31.00

If B. B. is omitted deduct \$5.10

Face and edges polished; back sand finished.

No. 4549 $\frac{1}{4}$

Die.....1.4 x 0.8 x 1.4..1.2
 B. Base.....1.8 x 1.0 x 0.8..1.1
 Weight complete 325 lbs.; no B. B. 130 lbs.

- C.....\$43.75
- D.....41.00
- F.....40.00
- G.....39.25
- H.....38.75
- I.....38.25
- K.....37.25
- L.....36.50

If B. B. is omitted deduct \$3.90

No. 4551 $\frac{1}{2}$

Die.....1.4 x 0.3 x 2.6..0.10
 B. Base.....1.9 x 0.8 x 0.8..0.9
 Weight complete 275 lbs.; no B. B. 140 lbs.

- C.....\$28.25
- D.....26.50
- F.....25.50
- G.....25.25
- H.....24.75
- I.....24.25
- K.....23.75
- L.....23.00

If B. B. is omitted deduct \$2.80

Face and edges polished; back sand finished.

No. 4552

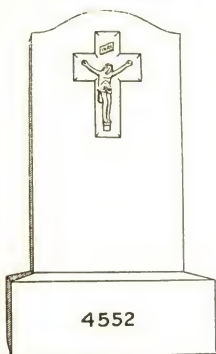

Die.....1.6 x 0.6 x 2. 6..1.11
 B. Base....2.0 x 1.0 x 0.10..1. 8
 Weight complete 625 lbs.; no B. B. 325 lbs.

C.....	\$50.50
D.....	46.00
F.....	44.00
G.....	43.00
H.....	42.00
I.....	41.25
K.....	39.75
L.....	38.25

If B. B. is omitted deduct \$6.00
 Face and edges polished; back sand finished.

No. 4552¹/₄

Die.....1.6 x 0. 4 x 2. 6..1.3
 B. Base....2.0 x 0.10 x 0.10..1.5
 Weight complete 475 lbs.; no B. B. 220 lbs.

C.....	\$39.00
D.....	36.25
F.....	34.75
G.....	34.25
H.....	33.50
I.....	33.00
K.....	32.00
L.....	31.00

If B. B. is omitted deduct \$5.10
 Face and edges polished; back sand finished.

No. 4552¹/₂

Die.....1.4 x 0.3 x 2.6..0.10
 B. Base....1.9 x 0.8 x 0.8..0. 9
 Weight complete 275 lbs.; no B. B. 140 lbs.

C.....	\$28.25
D.....	26.50
F.....	25.50
G.....	25.25
H.....	24.75
I.....	24.25
K.....	23.75
L.....	23.00

If B. B. is omitted deduct \$2.80
 Face and edges polished; back sand finished.

No. 4556

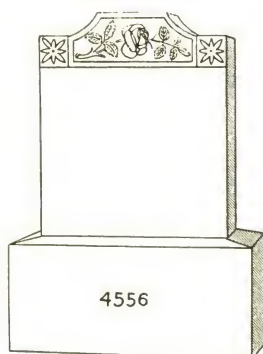

Die.....1. 6 x 0. 6 x 1. 8..1.3
 B. Base....1.10 x 0.10 x 0.10..1.3
 Weight complete 425 lbs.; no B. B. 200 lbs.

C.....	\$27.50
D.....	24.75
F.....	23.25
G.....	22.75
H.....	22.00
I.....	21.50
K.....	20.50
L.....	19.50

If B. B. is omitted deduct \$4.50

No. 4556¹/₄

Die.....1.4 x 0. 6 x 1. 6..1.0
 B. Base....1.8 x 0.10 x 0.10..1.2
 Weight complete 375 lbs.; no B. B. 165 lbs.

C.....	\$23.25
D.....	21.00
F.....	20.00
G.....	19.50
H.....	19.00
I.....	18.50
K.....	17.75
L.....	17.00

If B. B. is omitted deduct \$4.20

No. 4556¹/₂

Die.....1.4 x 0.4 x 1.6..0.8
 B. Base....1.8 x 0.8 x 0.8..0.9
 Weight complete 250 lbs.; no B. B. 115 lbs.

C.....	\$16.25
D.....	14.75
F.....	14.25
G.....	13.75
H.....	13.50
I.....	13.25
K.....	12.75
L.....	12.25

If B. B. is omitted deduct \$2.80

No. 4557

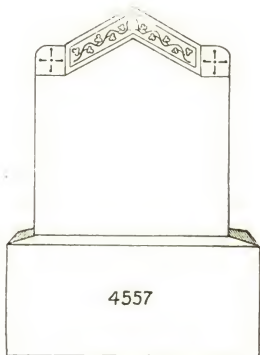

Sizes and prices same as No. 4556.

No. 4557¹/₄

Sizes and prices same as No. 4556¹/₄.

No. 4557¹/₂

Sizes and prices same as No. 4556¹/₂.

No. 4558

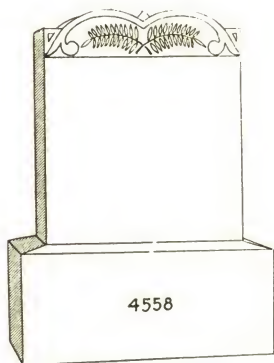

Sizes and prices same as No. 4556.

No. 4558¹/₄

Sizes and prices same as No. 4556¹/₄.

No. 4558¹/₂

Sizes and prices same as No. 4556¹/₂.

No. 4559

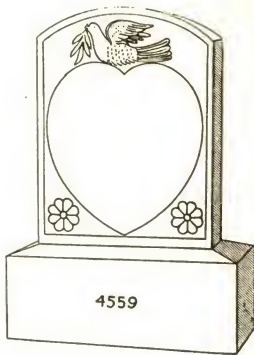

Die.....1.2 x 0.4 x 1.6..0.7
B. Base.....1.6 x 0.8 x 0.8..0.8

Weight complete 225 lbs.; no B. B. 105 lbs.

C.....	\$14.50
D.....	13.25
F.....	12.75
G.....	12.50
H.....	12.00
I.....	11.75
K.....	11.50
L.....	11.00

If B. B. is omitted deduct \$2.50

No. 4559¹/₄

Die.....1.0 x 0.4 x 1.4..0.5
B. Base.....1.4 x 0.8 x 0.8..0.7

Weight complete 175 lbs.; no B. B. 70 lbs.

C.....	\$11.25
D.....	10.25
F.....	10.00
G.....	9.75
H.....	9.50
I.....	9.25
K.....	8.75
L.....	8.50

If B. B. is omitted deduct \$2.20

No. 4560

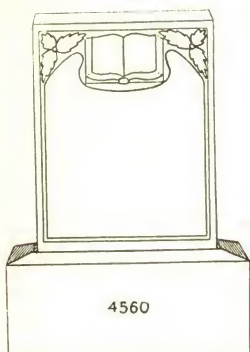

Sizes and prices same as No. 4559.

No. 4560¹/₄

Sizes and prices same as No. 4559¹/₄.

No. 4561

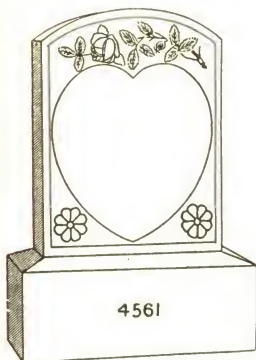

Sizes and prices same as No. 4559.

No. 4561¹/₄

Sizes and prices same as No. 4559¹/₄.

No. 4567



Die.....1.2 x 0.6 x 1.6..0.11
 B. Base...1.6 x 0.10 x 0.10..1.1
 Weight complete 325 lbs.; no B. B. 130 lbs.

- C.....\$29.50
- D.....27.50
- F.....26.50
- G.....26.00
- H.....25.50
- I.....25.25
- K.....24.50
- L.....23.75

If B. B. is omitted deduct \$3.90
 Face polished, balance sand finished

No. 4567¹/₄

Die.....1.2 x 0.4 x 1.6..0.7
 B. Base.....1.6 x 0.8 x 0.8..0.8
 Weight complete 200 lbs.; no B. B. 80 lbs.

- C.....\$22.75
- D.....21.50
- F.....21.00
- G.....20.75
- H.....20.25
- I.....20.00
- K.....19.75
- L.....19.25

If B. B. is omitted deduct \$2.50
 Face polished, balance sand finished

No. 4567¹/₂

Die.....1.0 x 0.4 x 1.4..0.5
 B. Base.....1.4 x 0.8 x 0.8..0.7
 Weight complete 150 lbs.; no B. B. 45 lbs.

- C.....\$18.50
- D.....17.50
- F.....17.25
- G.....17.00
- H.....16.75
- I.....16.50
- K.....16.00
- L.....15.75

If B. B. is omitted deduct \$2.20
 Face polished, balance sand finished

No. 4568

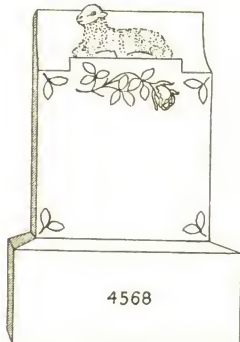

Die.....1.4 x 0.8 x 1.8..1.6
 B. Base.....1.8 x 1.0 x 0.10..1.5
 Weight complete 500 lbs.; no B. B. 245 lbs.

C.....	\$39.50
D.....	36.00
F.....	34.50
G.....	33.75
H.....	33.00
I.....	32.25
K.....	31.00
L.....	30.00

If B. B. is omitted deduct \$5.10
 Face polished, balance sand finished

No. 4568¹/₄

Die.....1.2 x 0.6 x 1.6..0.11
 B. Base.....1.6 x 0.10 x 0.8..0.10
 Weight complete 300 lbs.; no B. B. 150 lbs.

C.....	\$27.75
D.....	25.75
F.....	24.75
G.....	24.25
H.....	23.75
I.....	23.50
K.....	22.75
L.....	22.00

If B. B. is omitted deduct \$3.15
 Face polished, balance sand finished

No. 4568¹/₂

Die.....1.0 x 0.6 x 1.4..0.8
 B. Base.....1.4 x 0.10 x 0.8..0.9
 Weight complete 250 lbs.; no B. B. 115 lbs.

C.....	\$23.50
D.....	22.00
F.....	21.50
G.....	21.00
H.....	20.75
I.....	20.50
K.....	20.00
L.....	19.50

If B. B. is omitted deduct \$2.80
 Face polished, balance sand finished

No. 4569

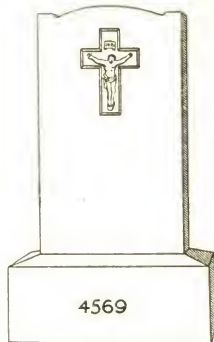

Die.....1.6 x 0.6 x 2.6..1.11
 B. Base.....2.0 x 1.0 x 0.10..1.8
 Weight complete 625 lbs.; no B. B. 325 lbs.

C.....	\$44.25
D.....	40.00
F.....	38.00
G.....	37.00
H.....	36.00
I.....	35.25
K.....	33.75
L.....	32.25

If B. B. is omitted deduct \$6.00
 Face only polished.

No. 4569¹/₄

Die.....1.6 x 0.4 x 2.6..1.3
 B. Base.....2.0 x 0.10 x 0.10..1.5
 Weight complete 475 lbs.; no B. B. 220 lbs.

C.....	\$34.25
D.....	31.50
F.....	30.00
G.....	29.50
H.....	28.75
I.....	28.25
K.....	27.25
L.....	26.25

If B. B. is omitted deduct \$5.10
 Face only polished

No. 4569¹/₂

Die.....1.4 x 0.3 x 2.6..0.10
 B. Base.....1.9 x 0.8 x 0.8..0.9
 Weight complete 275 lbs.; no B. B. 140 lbs.

C.....	\$24.75
D.....	23.00
F.....	22.00
G.....	21.75
H.....	21.25
I.....	20.75
K.....	20.25
L.....	19.50

If B. B. is omitted deduct \$2.80
 Face only polished

No. 4570

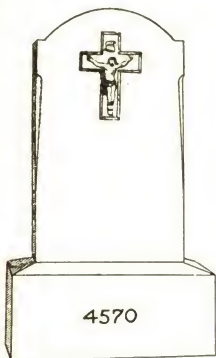

Price \$1.25 more than No. 4569.

No. 4570¹/₄

Price \$1.25 more than No. 4569¹/₄.

No. 4570¹/₂

Price \$1.25 more than No. 4569¹/₂.
 Sizes and finish of above design
 same as No. 4569.

No. 4571

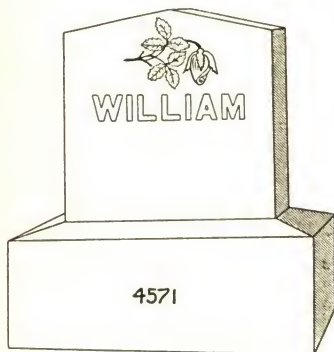

Die.....0.10 x 0.4 x 0.10 .0.3
 B. Base.....1. 2 x 0.8 x 0. 8. .0.6
 Weight complete 135 lbs.; no B. B. 45 lbs.

C.....	\$7.25
D.....	6.75
F.....	6.50
G.....	6.25
H.....	6.25
I.....	6.00
K.....	5.75
L.....	5.50

If B. B. is omitted deduct \$1.90
 Face only polished

No. 4572



Die.....0.10 x 0.4 x 0.10 .0.3
 B. Base.....1. 2 x 0.8 x 0. 8. .0.6
 Weight complete 135 lbs.; no B. B. 45 lbs.

C.....	\$7.25
D.....	6.75
F.....	6.50
G.....	6.25
H.....	6.25
I.....	6.00
K.....	5.75
L.....	5.50

If B. B. is omitted deduct \$1.90
 Face only polished

No. 4573



Sizes, prices and finish same as
 No. 4571.

No. 4576

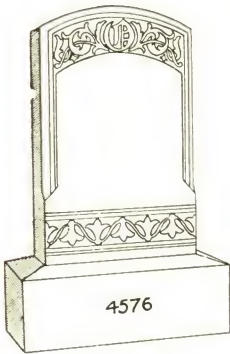

Die.....1.6 x 0.6 x 2. 6. .1.11
 B. Base....2.0 x 1.0 x 0.10. .1. 8
 Weight complete 625 lbs.; no B. B. 325 lbs.

C.....	\$38.25
D.....	34.00
F.....	32.00
G.....	31.00
H.....	30.00
I.....	29.25
K.....	27.75
L.....	26.25

If B. B. is omitted deduct \$6.00
 Face only polished

No. 4581

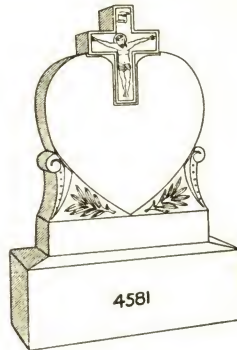

Die.....1.2 x 0. 6 x 1.8. .1. 0
 B. Base....1.6 x 0.10 x 0.8. .0.10
 Weight complete 300 lbs.; no B. B. 150 lbs.

C.....	\$28.00
D.....	25.75
F.....	24.75
G.....	24.25
H.....	23.75
I.....	23.25
K.....	22.50
L.....	21.75

If B. B. is omitted deduct \$3.15

No. 4581¹/₄

Die.....1.2 x 0.4 x 1.8. .0.8
 B. Base....1.6 x 0.8 x 0.8. .0.8
 Weight complete 225 lbs.; no B. B. 100 lbs.

C.....	\$21.75
D.....	20.25
F.....	19.75
G.....	19.25
H.....	19.00
I.....	18.75
K.....	18.25
L.....	17.75

If B. B. is omitted deduct \$2.50

No. 4576¹/₄

Die.....1.6 x 0. 4 x 2. 4. .1.2
 B. Base....2.0 x 0.10 x 0.10. .1.5
 Weight complete 450 lbs.; no B. B. 200 lbs.

C.....	\$26.25
D.....	23.50
F.....	22.50
G.....	21.75
H.....	21.25
I.....	20.75
K.....	19.75
L.....	19.00

If B. B. is omitted deduct \$5.10
 Face only polished

No. 4581¹/₂

Die.....1.0 x 0.4 x 1.6. .0.6
 B. Base....1.4 x 0.8 x 0.8. .0.7
 Weight complete 175 lbs.; no B. B. 70 lbs.

C.....	\$18.50
D.....	17.25
F.....	16.75
G.....	16.50
H.....	16.25
I.....	16.00
K.....	15.50
L.....	15.25

If B. B. is omitted deduct \$2.20

No. 4582

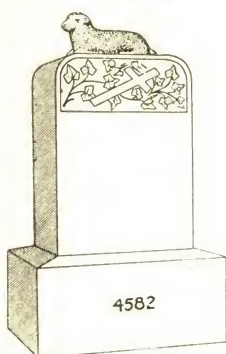

Die.....1.2 x 0.8 x 1.8..1.4
 B. Base.....1.6 x 1.0 x 0.8..1.0
 Weight complete 375 lbs.; no B. B. 200 lbs.

- C.....\$34.25
- D.....31.25
- F.....29.75
- G.....29.25
- H.....28.50
- I.....27.75
- K.....26.75
- L.....25.75

If B. B. is omitted deduct \$3.75
 Face only polished.

No. 4586

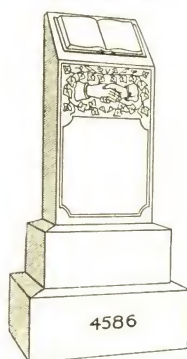

Die.....1.4 x 0.10 x 2.8..3.0
 Base.....1.8 x 1.2 x 0.8..1.4
 B. Base.....2.0 x 1.6 x 1.0..3.0
 Weight complete 1250 lbs.; no B. B. 710 lbs.

- C.....\$84.00
- D.....74.00
- F.....70.00
- G.....67.50
- H.....65.50
- I.....63.50
- K.....60.00
- L.....57.00

If B. B. is omitted deduct \$10.80

No. 4586¹/₄

Die.....1.2 x 0.8 x 2.6..1.11
 Base.....1.6 x 1.0 x 0.8..1.0
 B. Base...1.10 x 1.4 x 0.10..2.0
 Weight complete 850 lbs.; no B. B. 490 lbs.

- C.....\$61.00
- D.....54.50
- F.....51.50
- G.....50.00
- H.....48.50
- I.....47.25
- K.....45.00
- L.....42.75

If B. B. is omitted deduct \$7.20

No. 4582¹/₄

Die.....1.0 x 0.6 x 1.6..0.9
 B. Base.....1.4 x 0.10 x 0.8..0.9
 Weight complete 250 lbs.; no B. B. 115 lbs.

- C.....\$24.25
- D.....22.50
- F.....21.75
- G.....21.50
- H.....21.00
- I.....20.75
- K.....20.25
- L.....19.50

If B. B. is omitted deduct \$2.80
 Face only polished

No. 4586¹/₂

Die.....1.0 x 0.6 x 2.0..1.0
 Base.....1.4 x 0.10 x 0.6..0.7
 B. Base...1.8 x 1.2 x 0.10..1.7
 Weight complete 550 lbs.; no B. B. 285 lbs.

- C.....\$38.50
- D.....35.00
- F.....33.50
- G.....32.75
- H.....31.75
- I.....31.00
- K.....30.00
- L.....28.75

If B. B. is omitted deduct \$5.70

No. 4587

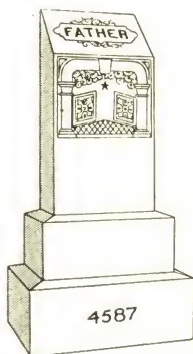

Die.....1.4 x 0.10 x 2.6..2.9
 Base.....1.8 x 1.2 x 0.8..1.4
 B. Base....2.0 x 1.6 x 1.0..3.0
 Weight complete 1175 lbs.; no B. B. 635 lbs.

- C.....\$75.00
- D.....66.00
- F.....62.00
- G.....60.00
- H.....58.00
- I.....56.00
- K.....53.00
- L.....49.75

If B. B. is omitted deduct \$10.80

No. 4587¹/₄

Die.....1.2 x 0.8 x 2.4..1.10
 Base.....1.6 x 1.0 x 0.8..1.0
 B. Base....1.10 x 1.4 x 0.10..2.0
 Weight complete 800 lbs.; no B. B. 440 lbs.

- C.....\$53.50
- D.....47.25
- F.....44.25
- G.....43.00
- H.....41.50
- I.....40.00
- K.....38.00
- L.....35.75

If B. B. is omitted deduct \$7.20

No. 4587¹/₂

Die.....1.0 x 0.6 x 2.0..1.0
 Base.....1.4 x 0.10 x 0.6..0.7
 B. Base....1.8 x 1.2 x 0.10..1.7
 Weight complete 525 lbs.; no B. B. 240 lbs.

- C.....\$33.75
- D.....30.25
- F.....28.75
- G.....28.00
- H.....27.00
- I.....26.25
- K.....25.25
- L.....24.00

If B. B. is omitted deduct \$5.70

No. 4589

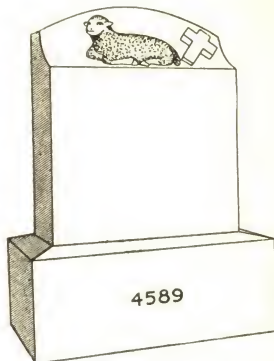

Die.....1.6 x 0.8 x 1.10..1.10
 B. Base....1.10 x 1.0 x 0.10..1.6
 Weight complete 575 lbs.; no B. B. 305 lbs.

- C.....\$48.50
- D.....44.50
- F.....42.50
- G.....41.75
- H.....40.75
- I.....39.75
- K.....38.50
- L.....37.00

If B. B. is omitted deduct \$5.40

No. 4589¹/₄

Die.....1.4 x 0.6 x 1.8..1.1
 B. Base....1.8 x 0.10 x 0.8..0.11
 Weight complete 350 lbs.; no B. B. 185 lbs.

- C.....\$34.75
- D.....32.25
- F.....31.25
- G.....30.75
- H.....30.00
- I.....29.50
- K.....28.75
- L.....28.00

If B. B. is omitted deduct \$3.45

No. 4589¹/₂

Die.....1.2 x 0.6 x 1.6..0.11
 B. Base....1.6 x 0.10 x 0.8..0.10
 Weight complete 300 lbs.; no B. B. 150 lbs.

- C.....\$33.25
- D.....31.25
- F.....30.25
- G.....29.75
- H.....29.25
- I.....29.00
- K.....28.25
- L.....27.50

If B. B. is omitted deduct \$3.15

No. 4590

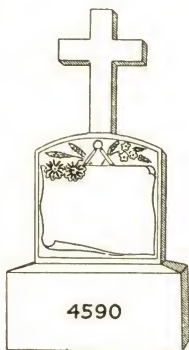

Cross.....0.8 x 0.2 x 0.10 .0.1
 Die.....1.0 x 0.4 x 1. 0 .0.4
 B. Base.....1.4 x 0.8 x 0. 8 .0.7
 Weight complete 175 lbs.; no B. B. 70 lbs.

- C.....\$17.00
 - D.....16.00
 - F.....15.75
 - G.....15.50
 - H.....15.25
 - I.....15.00
 - K.....14.50
 - L.....14.25
- If B. B. is omitted deduct \$2.20

No. 4592

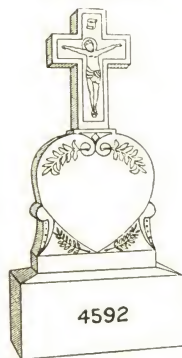

Cross.....0.10 x 0. 4 x 1.4 .0. 4
 Die.....1. 2 x 0. 6 x 1.6 .0.11
 B. Base....1. 6 x 0.10 x 0.8 .0.10
 Weight complete 350 lbs.; no B. B. 200 lbs.

- C.....\$36.00
 - D.....33.25
 - F.....31.75
 - G.....31.25
 - H.....30.50
 - I.....30.00
 - K.....29.00
 - L.....28.00
- If B. B. is omitted deduct \$3.15

No. 4592¹/₄

Cross.....0.10 x 0.3 x 1.2 .0.3
 Die.....1. 2 x 0.4 x 1.6 .0.7
 B. Base.....1. 6 x 0.8 x 0.8 .0.8
 Weight complete 250 lbs.; no B. B. 130 lbs.

- C.....\$27.75
 - D.....26.00
 - F.....25.00
 - G.....24.75
 - H.....24.25
 - I.....23.75
 - K.....23.25
 - L.....22.50
- If B. B. is omitted deduct \$2.50

No. 4591

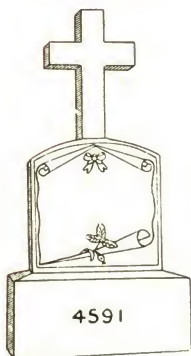

Sizes and prices same as No. 4590.

No. 4592¹/₂

Cross.....0.8 x 0.3 x 0.10 .0.2
 Die.....1.0 x 0.4 x 1. 2 .0.5
 B. Base.....1.4 x 0.8 x 0. 8 .0.7
 Weight complete 200 lbs.; no B. B. 95 lbs.

- C.....\$22.75
 - D.....21.50
 - F.....21.00
 - G.....20.75
 - H.....20.25
 - I.....20.00
 - K.....19.75
 - L.....19.25
- If B. B. is omitted deduct \$2.20

No. 4593

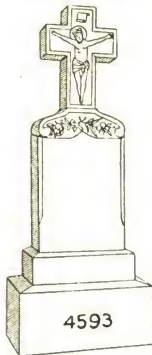

Cross.....	1.0 x 0.4 x 1.4	.0.5
Die.....	1.4 x 0.6 x 1.10	.1.3
Base.....	1.7 x 0.9 x 0.4	.0.5
B. Base....	2.0 x 1.2 x 0.10	.1.11
Weight complete 650 lbs.; no B. B. 305 lbs.		
C.....		\$51.50
D.....		46.75
F.....		44.75
G.....		43.75
H.....		42.50
I.....		41.50
K.....		40.00
L.....		38.50
If B. B. is omitted deduct \$6.90		

No. 4593 1/4

Cross.....	0.10 x 0.4 x 1.2	.0.4
Die.....	1.2 x 0.6 x 1.8	.1.0
Base.....	1.4 x 0.8 x 0.4	.0.4
B. Base....	1.8 x 1.0 x 0.10	.1.5
Weight complete 525 lbs.; no B. B. 270 lbs.		
C.....		\$44.50
D.....		40.75
F.....		39.25
G.....		38.25
H.....		37.50
I.....		36.75
K.....		35.50
L.....		34.25
If B. B. is omitted deduct \$5.10		

No. 4593 1/2

Cross.....	0.10 x 0.3 x 1.2	.0.3
Die.....	1.0 x 0.4 x 1.8	.0.7
Base.....	1.2 x 0.6 x 0.4	.0.2
B. Base....	1.6 x 0.10 x 0.10	.1.1
Weight complete 350 lbs.; no B. B. 155 lbs.		
C.....		\$34.50
D.....		32.25
F.....		31.25
G.....		30.75
H.....		30.25
I.....		29.75
K.....		29.00
L.....		28.25
If B. B. is omitted deduct \$3.90		

No. 4600

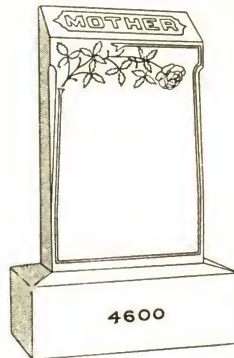

Die.....	1.6 x 0.6 x 2.6	.1.11
B. Base....	2.0 x 1.0 x 0.10	.1.8
Weight complete 625 lbs.; no B. B. 325 lbs.		
C.....		\$39.50
D.....		35.25
F.....		33.25
G.....		32.25
H.....		31.25
I.....		30.50
K.....		29.00
L.....		27.50
If B. B. is omitted deduct \$6.00		

No. 4600 1/4

Die.....	1.6 x 0.4 x 2.4	.1.2
B. Base....	2.0 x 0.10 x 0.10	.1.5
Weight complete 425 lbs.; no B. B. 170 lbs.		
C.....		\$28.00
D.....		25.25
F.....		24.25
G.....		23.50
H.....		23.00
I.....		22.50
K.....		21.50
L.....		20.75
If B. B. is omitted deduct \$5.10		

No. 4601

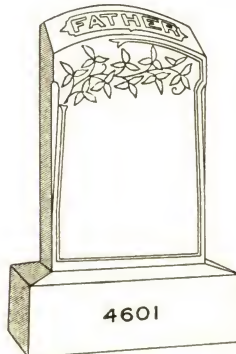

Sizes and prices same as No. 4600.

No. 4602

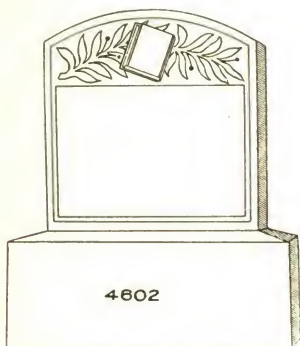

Die.....1.2 x 0.6 x 1.2 .0.8
 B. Base....1.6 x 0.10 x 0.8 .0.10
 Weight complete 250 lbs.; no B. B. 100 lbs.
 C.....\$15.75
 D.....14.25
 F.....13.75
 G.....13.25
 H.....13.00
 I.....12.75
 K.....12.25
 L.....11.75
 If B. B. is omitted deduct \$3.15

No. 4602 $\frac{1}{4}$

Die.....1.0 x 0.4 x 1.0 .0.4
 B. Base....1.4 x 0.8 x 0.8 .0.7
 Weight complete 160 lbs.; no B. B. 55 lbs.
 C.....\$10.75
 D.....10.00
 F.....9.75
 G.....9.50
 H.....9.25
 I.....9.00
 K.....8.75
 L.....8.50
 If B. B. is omitted deduct \$2.20

No. 4603

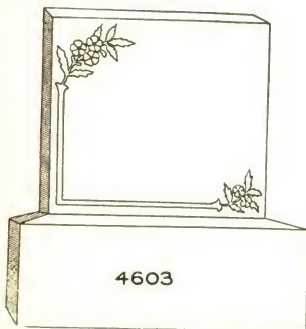

Sizes and prices same as No. 4602.

No. 4604

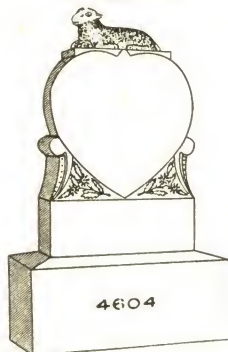

Die.....1.2 x 0.6 x 1.10 .1.1
 B. Base....1.6 x 0.10 x 0.8 .0.10
 Weight complete 350 lbs.; no B. B. 200 lbs.
 C.....\$33.75
 D.....31.25
 F.....30.25
 G.....29.75
 H.....29.00
 I.....28.50
 K.....27.75
 L.....27.00
 If B. B. is omitted deduct \$3.15

No. 4604 $\frac{1}{4}$

Die.....1.2 x 0.4 x 1.10 .0.9
 B. Base....1.6 x 0.8 x 0.8 .0.8
 Weight complete 250 lbs.; no B. B. 130 lbs.
 C.....\$25.75
 D.....24.25
 F.....23.25
 G.....23.00
 H.....22.50
 I.....22.25
 K.....21.75
 L.....21.00
 If B. B. is omitted deduct \$2.50

No. 4604 $\frac{1}{2}$

Die.....1.0 x 0.4 x 1.8 .0.7
 B. Base....1.4 x 0.8 x 0.8 .0.7
 Weight complete 200 lbs.; no B. B. 95 lbs.
 C.....\$22.75
 D.....21.50
 F.....21.00
 G.....20.75
 H.....20.25
 I.....20.00
 K.....19.75
 L.....19.25
 If B. B. is omitted deduct \$2.20

No. 4606

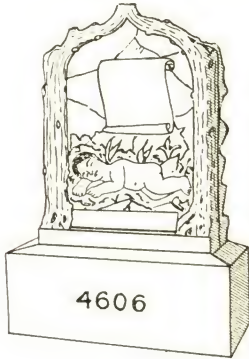

Die..... 1.4 x 0.8 x 1.10..1.8
 B. Base..... 1.8 x 1.0 x 0.10..1.5
 Weight complete 500 lbs.; no B. B. 245 lbs.

C.....	\$83.00
D.....	79.50
F.....	77.50
G.....	77.00
H.....	76.00
I.....	75.00
K.....	74.00
L.....	72.50

If B. B. is omitted deduct \$5.10

No. 4609

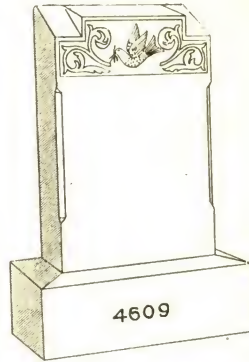

Die..... 1.6 x 0.8 x 2.4..2.4
 B. Base..... 2.0 x 1.2 x 1.0..2.4
 Weight complete 800 lbs.; no B. B. 380 lbs.

C.....	\$47.50
D.....	42.25
F.....	39.75
G.....	38.75
H.....	37.50
I.....	36.25
K.....	34.50
L.....	32.75

If B. B. is omitted deduct \$8.40

No. 4609¹/₄

Die..... 1.6 x 0.6 x 2.2..1.8
 B. Base..... 2.0 x 1.0 x 0.10..1.8
 Weight complete 575 lbs.; no B. B. 275 lbs.

C.....	\$35.00
D.....	31.25
F.....	29.75
G.....	28.75
H.....	28.00
I.....	27.25
K.....	26.00
L.....	24.75

If B. B. is omitted deduct \$6.00

No. 4609¹/₂

Die..... 1.4 x 0.4 x 1.10..0.10
 B. Base..... 1.9 x 0.9 x 0.10..1.1
 Weight complete 325 lbs.; no B. B. 130 lbs.

C.....	\$20.50
D.....	18.75
F.....	17.75
G.....	17.50
H.....	17.00
I.....	16.50
K.....	16.00
L.....	15.25

If B. B. is omitted deduct \$3.90

No. 4609¹/₂

See previous column.

No. 4612

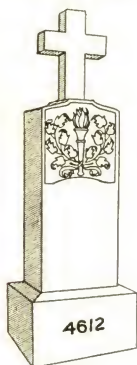

Cross.....1. 0 x 0. 4 x 1.4 .0.5
 Die.....1. 4 x 0.10 x 2.8 .3.0
 B. Base....1.10 x 1. 4 x 1.0 .2.5
 Weight complete 1000 lbs.; no B. B. 565 lbs.

C.....	\$68.50
D.....	60.50
F.....	57.50
G.....	55.50
H.....	54.00
I.....	52.00
K.....	49.50
L.....	47.00

If B. B. is omitted deduct \$8.70

No. 4612 1/4

Cross.....0.10 x 0.4 x 1.2 .0. 4
 Die.....1. 2 x 0.8 x 2.6 .1.11
 B. Base....1. 8 x 1.2 x 1.0 .1.11
 Weight complete 725 lbs.; no B. B. 380 lbs.

C.....	\$51.00
D.....	46.00
F.....	43.50
G.....	42.50
H.....	41.25
I.....	40.25
K.....	38.50
L.....	37.75

If B. B. is omitted deduct \$6.90

No. 4612 1/2

Cross.....0.10 x 0.3 x 1. 2 .0.3
 Die.....1. 0 x 0.8 x 2. 4 .1.7
 B. Base....1. 6 x 1.2 x 0.10 .1.6
 Weight complete 575 lbs.; no B. B. 300 lbs.

C.....	\$41.50
D.....	37.50
F.....	35.50
G.....	34.75
H.....	33.75
I.....	32.75
K.....	31.50
L.....	30.00

If B. B. is omitted deduct \$5.40

No. 4615

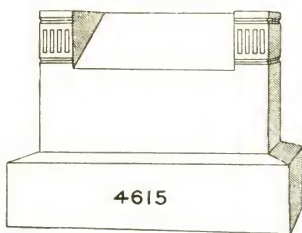

Die.....2.0 x 1.0 x 1.2 .2. 4
 B. Base....2.6 x 1.6 x 0.6 .1.11
 Weight complete 700 lbs.; no B. B. 355 lbs.

D.....	\$40.50
F.....	38.00
G.....	37.00
H.....	35.75
I.....	34.50
K.....	32.75
L.....	31.00

If B. B. is omitted deduct \$6.90

No. 4615 1/4

Die.....1.8 x 0.10 x 1.0 .1.5
 B. Base....2.2 x 1. 4 x 0.6 .1.5
 Weight complete 475 lbs.; no B. B. 220 lbs.

D.....	\$27.75
F.....	26.25
G.....	25.50
H.....	24.75
I.....	24.25
K.....	23.00
L.....	22.00

If B. B. is omitted deduct \$5.10

No. 4615 1/2

Die.....1.8 x 0.8 x 1.0 .1.1
 B. Base....2.0 x 1.0 x 0.6 .1.0
 Weight complete 350 lbs.; no B. B. 170 lbs.

D.....	\$21.50
F.....	20.50
G.....	20.00
H.....	19.25
I.....	18.75
K.....	18.00
L.....	17.25

If B. B. is omitted deduct \$3.75

No. 4616

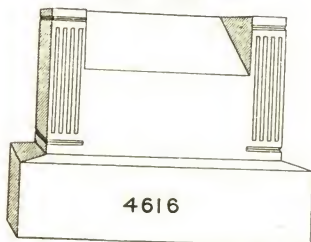

Sizes and prices same as No. 4615.

No. 4620



Die.....1.10 x 0.6 x 1. 6..1. 5
 B. Base...2. 4 x 1.0 x 0.10..1.11

Weight complete 550 lbs.; no B. B. 200 lbs.

C.....	\$40.50
D.....	37.25
F.....	35.75
G.....	35.00
H.....	34.25
I.....	33.75
K.....	32.50
L.....	31.50

If B. B. is omitted deduct \$6.90

No. 4624

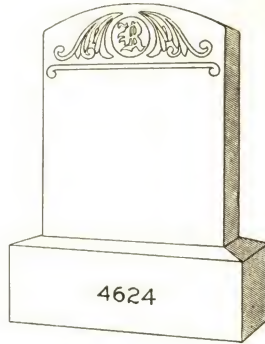

Die.....2. 4 x 0.10 x 2.8..5.2
 B. Base...2.10 x 1. 4 x 1.0..3.9

Weight complete 1575 lbs.; no B. B. 905 lbs.

C.....	\$93.00
D.....	81.50
F.....	76.50
G.....	74.00
H.....	71.50
I.....	68.50
K.....	65.00
L.....	61.00

If B. B. is omitted deduct \$13.15

No. 4624¹/₄

Die.....2.0 x 0.8 x 2.6..3. 4
 B Base...2.6 x 1.2 x 1.0..2.11

Weight complete 1100 lbs.; no B. B. 575 lbs.

C.....	\$65.50
D.....	58.00
F.....	55.00
G.....	53.00
H.....	51.50
I.....	49.75
K.....	47.25
L.....	44.75

If B. B. is omitted deduct \$10.50

No. 4620¹/₄

Die.....1.10 x 0. 4 x 1. 6..0.11
 B. Base...2. 4 x 0.10 x 0.10..1. 7

Weight complete 425 lbs.; no B. B. 140 lbs.

C.....	\$28.50
D.....	26.50
F.....	25.50
G.....	25.00
H.....	24.50
I.....	24.25
K.....	23.50
L.....	22.75

If B. B. is omitted deduct \$5.70

No. 4624¹/₂

Die.....1.8 x 0.6 x 2. 4..1.11
 B. Base...2.2 x 1.0 x 0.10..1.10

Weight complete 660 lbs.; no B. B. 330 lbs.

C.....	\$40.50
D.....	36.25
F.....	34.25
G.....	33.25
H.....	32.25
I.....	31.50
K.....	30.00
L.....	28.50

If B. B. is omitted deduct \$6.60

No. 4627

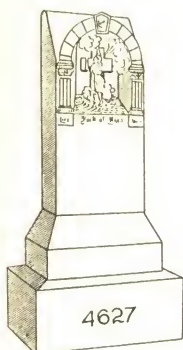

Die.....	1. 6 $\frac{1}{2}$ x 0.10 x 3. 6. .4. 5
Base.....	1.11 x 1. 3 x 0.10. .2. 0
B. Base.....	2. 5 $\frac{1}{2}$ x 1. 9 x 1. 0. .4. 3
Weight complete 1850 lbs.; no B. B. 1090 lbs.	
C.....	\$144.00
D.....	129.00
F.....	123.00
G.....	126.00
H.....	116.00
I.....	113.00
K.....	108.00
L.....	104.00
If B. B. is omitted deduct \$14.85	

No. 4627 $\frac{1}{4}$

Die.....	1.4 x 0.10 x 3. 0. .3. 4
Base.....	1.9 x 1. 3 x 0.10. .1.10
B. Base.....	2.3 x 1. 9 x 1. 0. .3.11
Weight complete 1600 lbs.; no B. B. 895 lbs.	
C.....	\$119.00
D.....	108.00
F.....	102.00
G.....	100.00
H.....	97.50
I.....	94.50
K.....	91.00
L.....	87.00
If B. B. is omitted deduct \$13.70	

No. 4627 $\frac{1}{2}$

Die.....	1.2 x 0.8 x 2.10. .2.2
Base.....	1.6 x 1.0 x 0. 8. .1.0
B. Base.....	2.0 x 1.6 x 1. 0. .3.0
Weight complete 1080 lbs.; no B. B. 540 lbs.	
C.....	\$87.00
D.....	80.00
F.....	77.00
G.....	75.50
H.....	74.00
I.....	72.00
K.....	70.00
L.....	67.50
If B. B. is omitted deduct \$10.80	

No. 4628

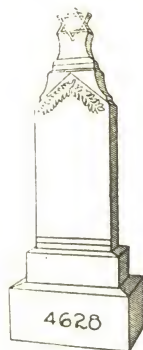

Finial.....	1.0 x 0. 5 x 1.6. .0. 8
Die.....	1.8 x 0.10 x 3.8. .5. 1
Base.....	2.0 x 1. 2 x 0.8. .1. 7
B. Base.....	2.6 x 1. 8 x 1.2. .4.10
Weight complete 2100 lbs.; no B. B. 1230 lbs.	
C.....	\$145.00
D.....	129.00
F.....	121.00
G.....	118.00
H.....	114.00
I.....	110.00
K.....	105.00
L.....	99.50
If B. B. is omitted deduct \$16.90	

No. 4628 $\frac{1}{4}$

Finial.....	0.10 x 0.4 x 1.4. .0.4
Die.....	1. 6 x 0.8 x 3.6. .3.6
Base.....	1.10 x 1.0 x 0.8. .1.3
B. Base.....	2. 4 x 1.6 x 1.0. .3.6
Weight complete 1475 lbs.; no B. B. 845 lbs.	
C.....	\$104.00
D.....	92.00
F.....	87.00
G.....	84.50
H.....	82.00
I.....	79.50
K.....	75.50
L.....	71.50
If B. B. is omitted deduct \$12.25	

No. 4628 $\frac{1}{2}$

Finial.....	0.9 x 0.4 x 1.4. .0.4
Die.....	1.4 x 0.8 x 3.4. .3.0
Base.....	1.8 x 1.0 x 0.8. .1.1
B. Base.....	2.2 x 1.6 x 1.0. .3.3
Weight complete 1325 lbs.; no B. B. 740 lbs.	
C.....	\$93.00
D.....	83.00
F.....	79.00
G.....	76.50
H.....	74.50
I.....	72.00
K.....	69.00
L.....	65.50
If B. B. is omitted deduct \$11.40	

No. 4634

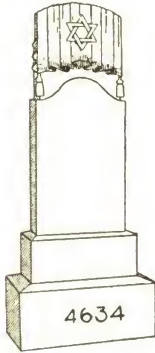

Die.....1.8 x 0.6 x 4.2. 3. 6
 Base.....2.0 x 0.10 x 0.10. 1. 5
 B. Base...2.6 x 1.4 x 1.2. 3. 11
 Weight complete 1500 lbs.; no B. B. 795 lbs.
 G.....\$99.00
 H.....96.50
 I.....94.00
 K.....90.50
 L.....87.00
 If B. B. is omitted deduct \$13.70.
 Face of die and base polished; balance sand finished.

No. 4635

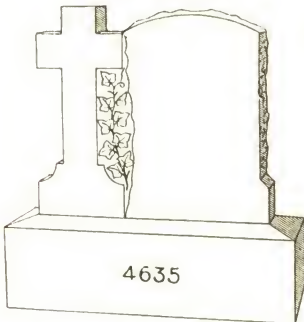

Die.....2.6 x 0.6 x 2.4. 2. 11
 B. Base...3.0 x 1.0 x 0.10. 2. 6
 Weight complete 900 lb.; no B. B. 450 lbs.
 C...\$60.00 H....\$47.50
 D...53.50 I....46.25
 F...50.50 K....44.00
 G...49.00 L....41.75
 If B. B. is omitted deduct \$9.00

No. 4635 1/4

Die.....2.2 x 0.4 x 2.0. 1. 5
 B. Base...2.8 x 0.10 x 0.10. 1. 10
 Weight complete 550 lbs.; no B. B. 220 lbs.
 C...\$34.50 H....\$28.25
 D...31.25 I....27.75
 F...29.75 K....26.50
 G...29.00 L....25.50
 If B. B. is omitted deduct \$6.60

No. 4636



Die.....1.2 x 0.4 x 1.6. 0.7
 B. Base...1.6 x 0.8 x 0.8. 0.8
 Weight complete 220 lbs.; no B. B. 100 lbs.
 C.....\$14.50
 D.....13.25
 F.....12.75
 G.....12.50
 H.....12.00
 I.....11.75
 K.....11.50
 L.....11.00
 If B. B. is omitted deduct \$2.50

No. 4636 1/4

Die.....1.0 x 0.4 x 1.4. 0.5
 B. Base...1.4 x 0.8 x 0.8. 0.7
 Weight complete 180 lbs.; no B. B. 75 lbs.
 C.....\$10.75
 D.....9.75
 F.....9.50
 G.....9.25
 H.....9.00
 I.....8.75
 K.....8.25
 L.....8.00
 If B. B. is omitted deduct \$2.20

No. 4637

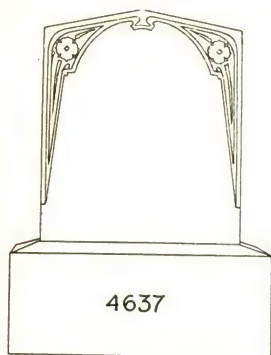

Sizes and prices same as No. 4636.

No. 4637 $\frac{1}{4}$

Sizes and prices same as No. 4636 $\frac{1}{4}$.

No. 4638

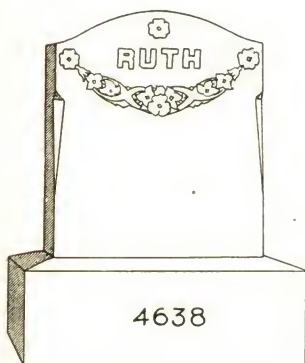

Sizes and prices same as No. 4636.

No. 4638 $\frac{1}{4}$

Sizes and prices same as No. 4636 $\frac{1}{4}$.

No. 4639

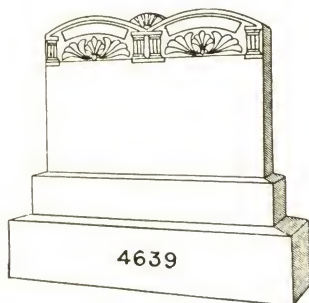

Die.....2. 8 x 0.6 x 2. 0..2.8
 Base.....2.11 x 0.9 x 0. 6..1.1
 B. Base....3. 4 x 1.2 x 0.10..3.3

Weight complete 1200 lbs.; no B.B. 615 lbs

C.....	\$75.00
D.....	66.50
F.....	62.50
G.....	61.00
H.....	59.00
I.....	57.00
K.....	54.00
L.....	51.50

If B. B. is omitted deduct \$11.40

No. 4639 $\frac{1}{4}$

Die.....2. 8 x 0.4 x 2. 0..1.9
 Base.....2.11 x 0.7 x 0. 5..0.9
 B. Base....3. 4 x 1.0 x 0.10..2.9

Weight complete 900 lbs.; no B. B. 405 lbs.

C.....	\$57.50
D.....	52.00
F.....	49.25
G.....	48.00
H.....	46.75
I.....	45.50
K.....	43.50
L.....	41.75

If B. B. is omitted deduct \$9.90

No. 4641

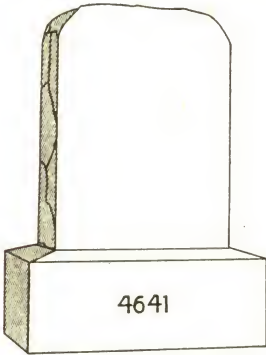

Die.....1.4 x 0.8 x 1.8..1.6.
 B. Base.....1.8 x 1.0 x 0.10..1.5.
 Weight complete 475 lbs.; no B. B. 220 lbs.
 Rutland White,
 Riv., S. F., Blue
 or P. V.....\$20.75
 If B. B. is omitted deduct \$5.10
 Face polished; top edges and back cut
 rock.

No. 4641¹/₄

Die.....1.2 x 0.6 x 1.6..0.11
 B. Base.....1.6 x 0.10 x 0.8..0.10
 Weight complete 300 lbs.; no B. B. 150 lbs.
 Rutland White
 Riv., S. F., Blue
 or P. V.....\$13.75
 If B. B. is omitted deduct \$3.15
 Face polished; top edges and back cut
 rock.

No. 4642

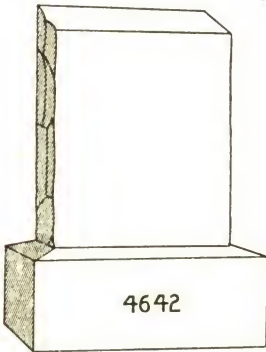

Sizes and prices same as No. 4641.
 Top and face polished; edges and back
 cut rock.

No. 4643

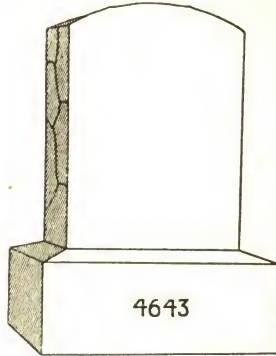

Sizes, prices and finish same as
 No. 4641.

No. 4644

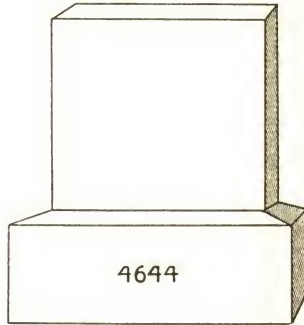

Die.....1.2 x 0.6 x 1.2..0.8
 B. Base.....1.6 x 0.10 x 0.8..0.10
 Weight complete 260 lbs.; no B. B. 110 lbs.
 Rutland White,
 Riv., S. F., Blue
 or P. V.....\$9.25
 If B. B. is omitted deduct \$3.15
 Face and bevel polished; balance sand
 finished.

No. 4644¹/₄

Die.....0.10 x 0.4 x 0.10..0.3
 B. Base.....1.2 x 0.8 x 0.8..0.6
 Weight complete 130 lbs.; no B. B. 40 lbs.
 Rutland White,
 Riv., S. F., Blue
 or P. V.....\$4.75
 If B. B. is omitted deduct \$1.90
 Face and bevel polished; balance sand
 finished.

No. 4645

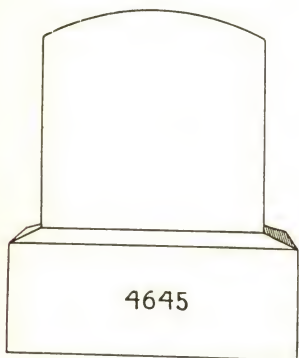

Sizes and prices same as No. 4644.
Face only polished; balance sand finished.

No. 4645 $\frac{1}{4}$

Sizes and prices same as No. 4644 $\frac{1}{4}$.

No. 4646

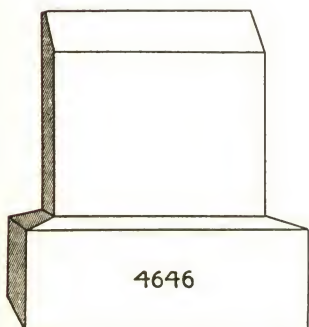

Sizes and prices same as No. 4644.
Face, bevel and top polished; balance sand finished.

No. 4646 $\frac{1}{4}$

Sizes and prices same as No. 4644 $\frac{1}{4}$.

No. 4647

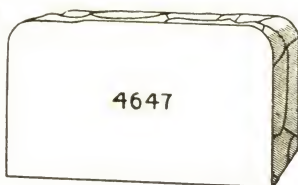

Die.....1.8 x 0.8 x 1.0...1.1
Weight complete 180 lbs.
Rutland White,
Riv., S. F., Blue
or P. V.....\$10.75
Face polished; top, edges and back cut
rock.

No. 4648

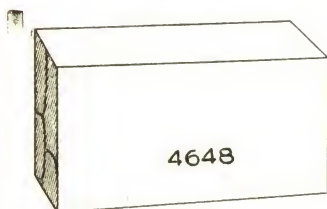

Sizes and prices same as No. 4647.
Top and face polished; edges and back cut rock.

No. 4649

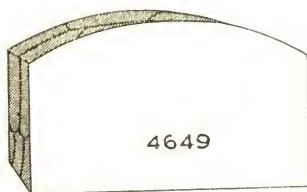

Sizes, prices and finish same as No. 4647.

No. 4657

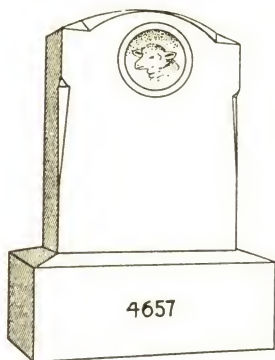

Die.....1. 4 x 0.6 x 1. 8. .1.1
 B. Base.....1.10 x 1.0 x 0.10. .1.6
 Weight complete 450 lbs.; no B. B. 180 lbs.

C.....	\$28.25
D.....	25.75
F.....	24.75
G.....	24.25
H.....	23.50
I.....	23.00
K.....	22.25
L.....	21.50
If B. B. is omitted deduct \$5.40	

No. 4657¹/₄

Die.....1.2 x 0. 6 x 1.6. .0.11
 B. Base.....1.6 x 0.10 x 0.8. .0.10
 Weight complete 300 lbs.; no B. B. 150 lbs.

C.....	\$22.50
D.....	20.50
F.....	19.50
G.....	19.00
H.....	18.50
I.....	18.25
K.....	17.50
L.....	16.75
If B. B. is omitted deduct \$3.15	

No. 4657¹/₂

Die.....1.2 x 0.4 x 1.6. .0.7
 B. Base.....1.6 x 0.8 x 0.8. .0.8
 Weight complete 220 lbs.; no B. B. 100 lbs.

C.....	\$16.75
D.....	15.50
F.....	15.00
G.....	14.75
H.....	14.25
I.....	14.00
K.....	13.75
L.....	13.25
If B. B. is omitted deduct \$2.50	

No. 4657³/₄

See next column.

No. 4663

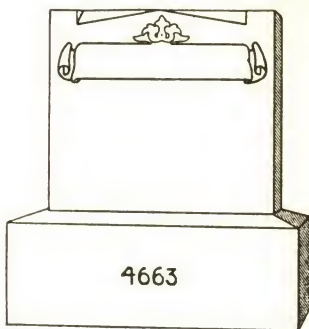

Die.....1.4 x 0.4 x 1.2. .0.6
 B. Base.....1.8 x 0.8 x 0.8. .0.9
 Weight complete 225 lbs.; no B. B. 90 lbs.

C.....	\$14.50
D.....	13.25
F.....	12.75
G.....	12.50
H.....	12.25
I.....	12.00
K.....	11.50
L.....	11.25
If B. B. is omitted deduct \$2.80	

No. 4663¹/₄

Die.....1.2 x 0.4 x 1.0. .0.5
 B. Base.....1.6 x 0.8 x 0.8. .0.8
 Weight complete 195 lbs.; no B. B. 75 lbs.

C.....	\$11.50
D.....	10.50
F.....	10.25
G.....	10.00
H.....	9.75
I.....	9.50
K.....	9.00
L.....	8.75
If B. B. is omitted deduct \$2.50	

No. 4657³/₄

Die.....1.0 x 0.4 x 1.4. .0.5
 B. Base.....1.4 x 0.8 x 0.8. .0.7
 Weight complete 180 lbs.; no B. B. 75 lbs.

C.....	\$13.25
D.....	12.25
F.....	12.00
G.....	11.75
H.....	11.50
I.....	11.25
K.....	10.75
L.....	10.50
If B. B. is omitted deduct \$2.20	

No. 4664

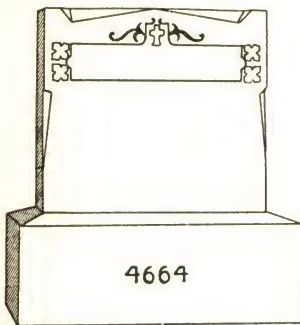

Sizes and prices same as No. 4663.

No. 4664¹/₄

Sizes and prices same as No. 4663¹/₄.

No. 4665

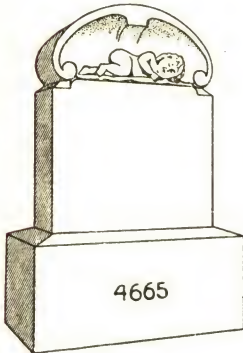

Die.....1.4 x 0.6 x 1.8...1.1
 B. Base....1.8 x 0.10 x 0.10...1.2
 Weight complete 375 lbs.; no B. B. 165 lbs.

C.....	\$55.50
D.....	53.00
F.....	52.00
G.....	51.50
H.....	51.00
I.....	50.50
K.....	49.50
L.....	48.75

If B. B. is omitted deduct \$4.20

No. 4668

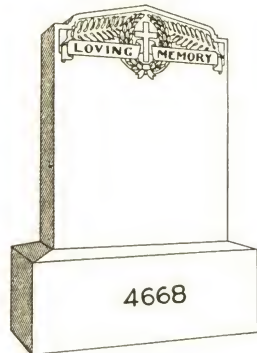

Die.....2.0 x 0.8 x 2.6...3.4
 B. Base....2.6 x 1.2 x 1.0...2.11
 Weight complete 1025 lbs.; no B. B. 500 lbs.

C.....	\$66.50
D.....	59.00
F.....	56.00
G.....	54.00
H.....	52.50
I.....	51.00
K.....	48.25
L.....	45.75

If B. B. is omitted deduct \$10.50

No. 4668¹/₄

Die.....1.8 x 0.6 x 2.4...1.11
 B. Base....2.2 x 1.0 x 0.10...1.10
 Weight complete 625 lbs.; no B. B. 300 lbs.

C.....	\$41.75
D.....	37.50
F.....	35.50
G.....	34.50
H.....	33.50
I.....	32.75
K.....	31.25
L.....	29.75

If B. B. is omitted deduct \$6.60

No. 4668¹/₂

Die.....1.6 x 0.4 x 2.2...1.1
 B. Base....2.0 x 0.10 x 0.10...1.5
 Weight complete 425 lbs.; no B. B. 170 lbs.

C.....	\$28.25
D.....	25.75
F.....	24.75
G.....	24.25
H.....	23.50
I.....	23.00
K.....	22.25
L.....	21.50

If B. B. is omitted deduct \$5.10

No. 4676

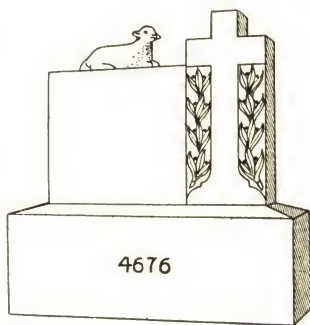

Die.....1.10 x 0.6 x 1. 6..1. 5
 B. Base....2. 4 x 1.0 x 0.10..1.11
 Weight complete 550 lbs.; no B. B. 205 lbs.

- C.....\$40.50
- D.....37.25
- F.....35.75
- G.....35.00
- H.....34.25
- I.....33.75
- K.....32.50
- L.....31.50

If B. B. is omitted deduct \$6.90

No. 4678

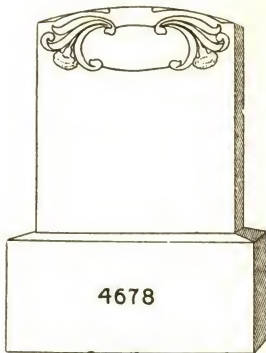

Die.....1. 6 x 0. 6 x 1. 8..1.3
 B. Base....1.10 x 0.10 x 0.10..1.3
 Weight complete 425 lbs.; no B. B. 200 lbs.

- C.....\$28.75
- D.....26.00
- F.....24.50
- G.....24.00
- H.....23.25
- I.....22.75
- K.....21.75
- L.....20.75

If B. B. is omitted deduct \$4.50

No. 4678¹/₄

Die.....1.4 x 0. 6 x 1. 6..1.0
 B. Base....1.8 x 0.10 x 0.10..1.2
 Weight complete 375 lbs.; no B. B. 165 lbs.

- C.....\$24.00
- D.....21.75
- F.....20.75
- G.....20.25
- H.....19.75
- I.....19.25
- K.....18.50
- L.....17.75

If B. B. is omitted deduct \$4.20

No. 4676¹/₄

Die.....1.10 x 0. 4 x 1. 6..0.11
 B. Base....2. 4 x 0.10 x 0.10..1. 7
 Weight complete 425 lbs.; no B. B. 140 lbs.

- C.....\$28.50
- D.....26.50
- F.....25.50
- G.....25.00
- H.....24.50
- I.....24.25
- K.....23.50
- L.....22.75

If B. B. is omitted deduct \$5.70

No. 4678¹/₂

Die.....1.4 x 0.4 x 1.6..0.8
 B. Base....1.8 x 0.8 x 0.8..0.9
 Weight complete 225 lbs.; no B. B. 90 lbs.

- C.....\$17.00
- D.....15.50
- F.....15.00
- G.....14.50
- H.....14.25
- I.....14.00
- K.....13.50
- L.....13.00

If B. B. is omitted deduct \$2.80

No. 4679

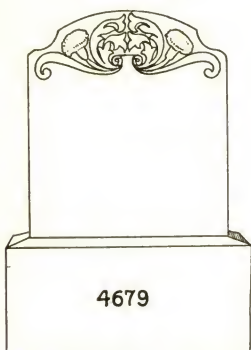

Die.....1. 6 x 0. 6 x 1. 8. .1.3
 B. Base....1.10 x 0.10 x 0.10. .1.3
 Weight complete 425 lbs.; no B. B. 200 lbs.

C.....	\$28.75
D.....	26.00
F.....	24.50
G.....	24.00
H.....	23.25
I.....	22.75
K.....	21.75
L.....	20.75

If B. B. is omitted deduct \$4.50

No. 4679¹/₄

Die.....1.4 x 0. 6 x 1. 6. .1.0
 B. Base....1.8 x 0.10 x 0.10. .1.2
 Weight complete 375 lbs.; no B. B. 165 lbs.

C.....	\$24.00
D.....	21.75
F.....	20.75
G.....	20.25
H.....	19.75
I.....	19.25
K.....	18.50
L.....	17.75

If B. B. is omitted deduct \$4.20

No. 4679¹/₂

Die.....1.4 x 0.4 x 1.6. .0.8
 B. Base....1.8 x 0.8 x 0.8. .0.9
 Weight complete 225 lbs.; no B. B. 90 lbs.

C.....	\$17.00
D.....	15.50
F.....	15.00
G.....	14.50
H.....	14.25
I.....	14.00
K.....	13.50
L.....	13.00

If B. B. is omitted deduct \$2.80

No. 4680

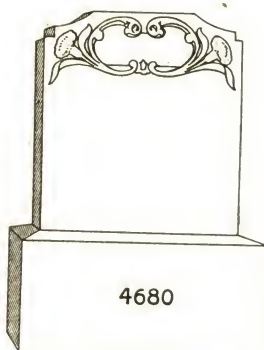

Die.....1. 6 x 0. 6 x 1. 8. .1.3
 B. Base....1.10 x 0.10 x 0.10. .1.3
 Weight complete 425 lbs.; no B. B. 200 lbs.

C.....	\$28.75
D.....	26.00
F.....	24.50
G.....	24.00
H.....	23.25
I.....	22.75
K.....	21.75
L.....	20.75

If B. B. is omitted deduct \$4.50

No. 4680¹/₄

Die.....1.4 x 0. 6 x 1. 6. .1.0
 B. Base....1.8 x 0.10 x 0.10. .1.2
 Weight complete 375 lbs.; no B. B. 165 lbs.

C.....	\$24.00
D.....	21.75
F.....	20.75
G.....	20.25
H.....	19.75
I.....	19.25
K.....	18.50
L.....	17.75

If B. B. is omitted deduct \$4.20

No. 4680¹/₂

Die.....1.4 x 0.4 x 1.6. .0.8
 B. Base....1.8 x 0.8 x 0.8. .0.9
 Weight complete 225 lbs.; no B. B. 90 lbs.

C.....	\$17.00
D.....	15.50
F.....	15.00
G.....	14.50
H.....	14.25
I.....	14.00
K.....	13.50
L.....	13.00

If B. B. is omitted deduct \$2.80

No. 4686

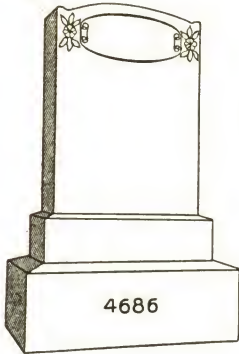

Die.....1.6 x 0.6 x 2. 0. .1.6
 Base.....1.9 x 0.9 x 0. 5. .0.7
 B. Base.....2.2 x 1.2 x 0.10. .2.1
 Weight complete 725 lbs.; no B. B. 350 lbs.

- C.....\$45.00
 - D.....40.25
 - F.....38.25
 - G.....37.25
 - H.....36.00
 - I.....35.00
 - K.....33.50
 - L.....32.00
- If B. B. is omitted deduct \$7.50

No. 4687

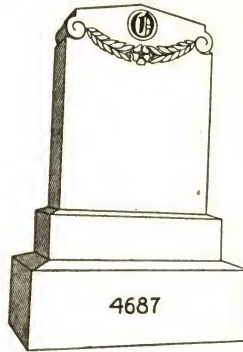

Die.....1.6 x 0.6 x 2. 0. .1.6
 Base.....1.9 x 0.9 x 0. 5. .0.7
 B. Base.....2.2 x 1.2 x 0.10. .2.1
 Weight complete 725 lbs.; no B. B. 350 lbs.

- C.....\$46.00
 - D.....41.25
 - F.....39.25
 - G.....38.25
 - H.....37.00
 - I.....36.00
 - K.....34.50
 - L.....33.00
- If B. B. is omitted deduct \$7.50

No. 4686¹/₄

Die.....1.6 x 0.4 x 2. 0. .1. 0
 Base.....1.9 x 0.7 x 0. 4. .0. 4
 B. Base.....2.2 x 1.0 x 0.10. .1.10
 Weight complete 550 lbs.; no B. B. 220 lbs.

- C.....\$33.00
 - D.....30.00
 - F.....28.50
 - G.....28.00
 - H.....27.25
 - I.....26.50
 - K.....25.50
 - L.....24.50
- If B. B. is omitted deduct \$6.60

No. 4687¹/₄

Die.....1.6 x 0.4 x 2. 0. .1. 0
 Base.....1.9 x 0.7 x 0. 4. .0. 4
 B. Base.....2.2 x 1.0 x 0.10. .1.10
 Weight complete 550 lbs.; no B. B. 220 lbs.

- C.....\$34.00
 - D.....31.00
 - F.....29.50
 - G.....29.00
 - H.....28.25
 - I.....27.50
 - K.....26.50
 - L.....25.50
- If B. B. is omitted deduct \$6.60

No. 4688

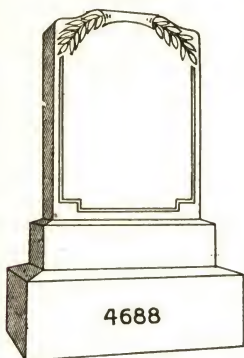

Die.....1.6 x 0.6 x 2. 0..1.6
 Base.....1.9 x 0.9 x 0. 5..0.7
 B. Base.....2.2 x 1.2 x 0.10..2.1
 Weight complete 725 lbs.; no B. B. 350 lbs.

- C..... \$45.00
 - D..... 40.25
 - F..... 38.25
 - G..... 37.25
 - H..... 36.00
 - I..... 35.00
 - K..... 33.50
 - L..... 32.00
- If B. B. is omitted deduct \$7.50

No. 4691

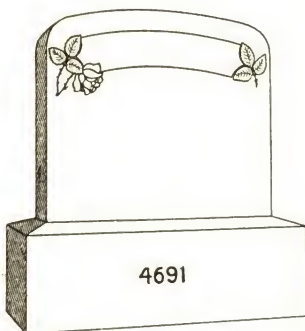

Die.....1. 6 x 0.4 x 1.4..0. 8
 B. Base.....1.10 x 0.8 x 0.8..0.10
 Weight complete 265 lbs.; no B. B. 115 lbs.

- C..... \$16.00
 - D..... 14.50
 - F..... 14.00
 - G..... 13.50
 - H..... 13.25
 - I..... 13.00
 - K..... 12.50
 - L..... 12.00
- If B. B. is omitted deduct \$3.15

No. 4688¹/₄

Die.....1.6 x 0.4 x 2. 0..1. 0
 Base.....1.9 x 0.7 x 0. 4..0. 4
 B. Base.....2.2 x 1.0 x 0.10..1.10
 Weight complete 550 lbs.; no B. B. 220 lbs.

- C..... \$33.00
 - D..... 30.00
 - F..... 28.50
 - G..... 28.00
 - H..... 27.25
 - I..... 26.50
 - K..... 25.50
 - L..... 24.50
- If B. B. is omitted deduct \$6.60

No. 4691¹/₄

Die.....1.4 x 0.4 x 1.2..0.6
 B. Base.....1.8 x 0.8 x 0.8..0.9
 Weight complete 220 lbs.; no B. B. 85 lbs.

- C..... \$14.25
 - D..... 13.00
 - F..... 12.50
 - G..... 12.25
 - H..... 12.00
 - I..... 11.75
 - K..... 11.25
 - L..... 11.00
- If B. B. is omitted deduct \$2.80

No. 4692

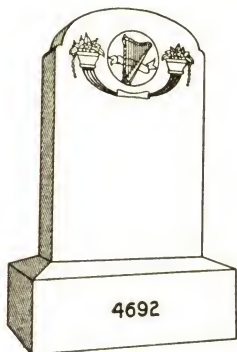

Die.....1.6 x 0.6 x 2. 6..1.11
 B. Base....2.0 x 1.0 x 0.10..1. 8
 Weight complete 650 lbs.; no B. B. 350 lbs.

- C.....\$38.25
 - D.....34.00
 - F.....32.00
 - G.....31.00
 - H.....30.00
 - I.....29.25
 - K.....27.75
 - L.....26.25
- If B. B. is omitted deduct \$6.00

No. 4695—A

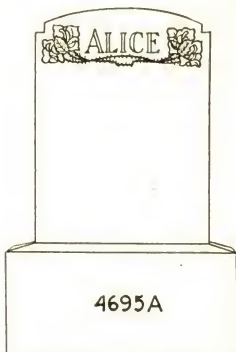

Die.....1.2 x 0.4 x 1.6..0.7
 B. Base.....1.6 x 0.8 x 0.8..0.8
 Weight complete 225 lbs.; no B. B. 105 lbs.

- C.....\$15.00
 - D.....13.75
 - F.....13.25
 - G.....13.00
 - H.....12.50
 - I.....12.25
 - K.....12.00
 - L.....11.50
- If B. B. is omitted deduct \$2.50

No. 4692¹/₄

Die.....1.6 x 0. 4 x 2. 4..1.2
 B. Base....2.0 x 0.10 x 0.10..1.5
 Weight complete 460 lbs.; no B. B. 250 lbs.

- C.....\$26.25
 - D.....23.50
 - F.....22.50
 - G.....21.75
 - H.....21.25
 - I.....20.75
 - K.....19.75
 - L.....19.00
- If B. B. is omitted deduct \$5.10

No. 4695¹/₄—A

Die.....1.0 x 0.4 x 1.4..0.5
 B. Base.....1.4 x 0.8 x 0.8..0.7
 Weight complete 180 lbs.; no B. B. 75 lbs.

- C.....\$11.25
 - D.....10.25
 - F.....10.00
 - G.....9.75
 - H.....9.50
 - I.....9.25
 - K.....8.75
 - L.....8.50
- If B. B. is omitted deduct \$2.20

No. 4695—B

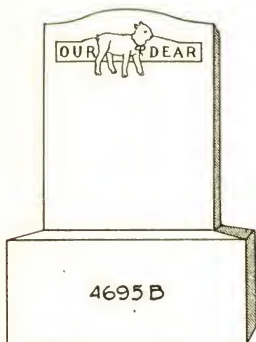

Sizes and prices same as No. 4695-A.

No. 4695—D

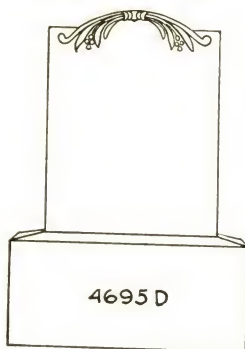

Sizes and prices same as No. 4695-A.

No. 4695—E

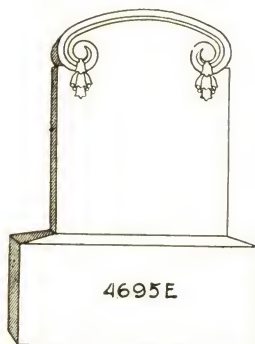

Sizes and prices same as No. 4695-A.

No. 4695—C

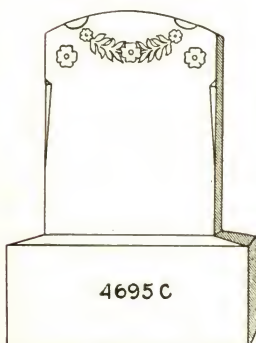

Sizes and prices same as No. 4695-A.

No. 4695—F

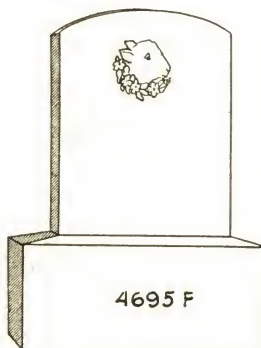

Sizes and prices same as No. 4695-A.

No. 4695—G

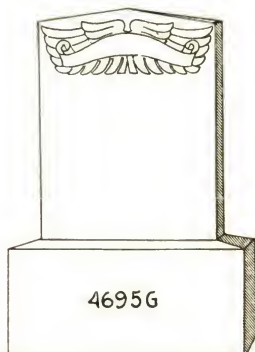

4695G

Sizes and prices same as No. 4695-A.

No. 4695—K

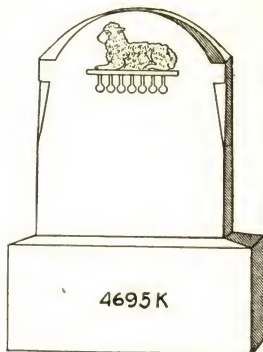

4695K

Sizes and prices same as No. 4695-A.

No. 4695—H

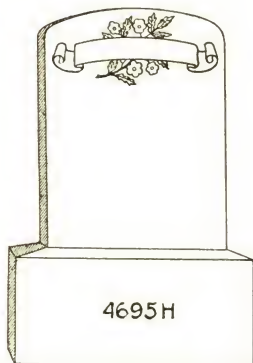

4695H

Sizes and prices same as No. 4695-A.

No. 4695—L

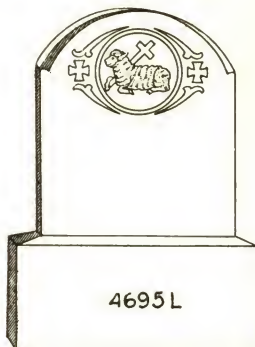

4695L

Sizes and prices same as No. 4695-A.

No. 4695—J

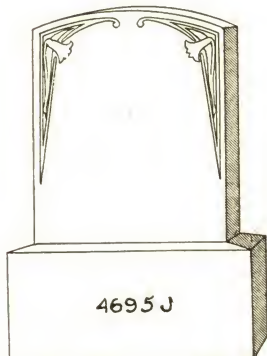

4695J

Sizes and prices same as No. 4695-A.

No. 4695—M

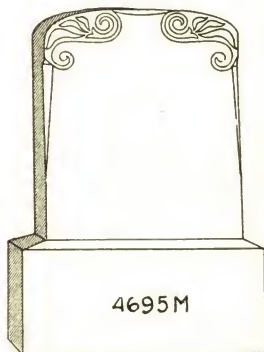

4695M

Sizes and prices same as No. 4695-A.

No. 4698

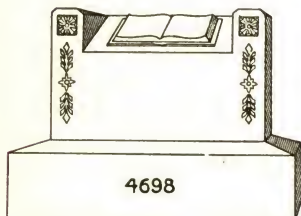

Die.....2.0 x 1.0 x 1.2..2. 4
 B. Base.....2.6 x 1.6 x 0.6..1.11
 *Veight complete 700 lbs.; no B. B. 355 lbs.

C.....	\$48.25
D.....	43.00
F.....	40.50
G.....	39.50
H.....	38.25
I.....	37.00
K.....	35.25
L.....	33.50

If B. B. is omitted deduct \$6.90

No. 4698 $\frac{1}{4}$

Die.....1.8 x 0.10 x 1.0..1.5
 B. Base.....2.2 x 1. 4 x 0.6..1.5
 Weight complete 475 lbs.; no B. B. 220 lbs.

C.....	\$34.00
D.....	30.75
F.....	29.25
G.....	28.50
H.....	27.75
I.....	27.25
K.....	26.00
L.....	25.00

If B. B. is omitted deduct \$5.10

No. 4698 $\frac{1}{2}$

Die.....1.8 x 0.8 x 1.0..1.1
 B. Base.....2.0 x 1.0 x 0.6..1.0
 Weight complete 350 lbs.; no B. B. 170 lbs.

C.....	\$27.75
D.....	25.25
F.....	24.25
G.....	23.75
H.....	23.00
I.....	22.50
K.....	21.75
L.....	21.00

If B. B. is omitted deduct \$3.75

No. 4701

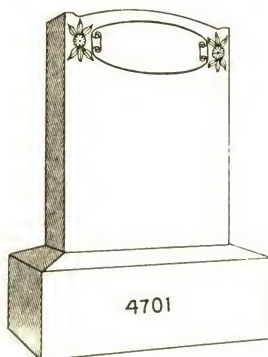

Die.....1.6 x 0.6 x 2. 0..1.6
 B. Base.....2.0 x 1.0 x 0.10..1.8
 Weight complete 550 lbs.; no B. B. 250 lbs.

C.....	\$33.75
D.....	30.25
F.....	28.75
G.....	28.00
H.....	27.25
I.....	26.50
K.....	25.25
L.....	24.25

If B. B. is omitted deduct \$6.00

No. 4701 $\frac{1}{4}$

Die.....1.6 x 0. 4 x 2. 0..1.0
 B. Base.....2.0 x 0.10 x 0.10..1.5
 Weight complete 425 lbs.; no B. B. 170 lbs.

C.....	\$25.00
D.....	22.75
F.....	21.75
G.....	21.25
H.....	20.75
I.....	20.25
K.....	19.50
L.....	18.75

If B. B. is omitted deduct \$5.10

No. 4702

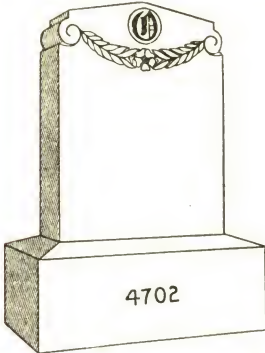

Die.....1.6 x 0.6 x 2. 0..1.6
 B. Base.....2.0 x 1.0 x 0.10..1.8
 Weight complete 550 lbs.; no B. B. 250 lbs.
 C.....\$35.00
 D.....31.50
 F.....30.00
 G.....29.25
 H.....28.50
 I.....27.75
 K.....26.50
 L.....25.50
 If B. B. is omitted deduct \$6.00

No. 4703

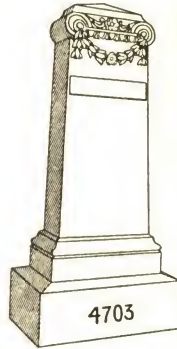

Die.....2. 0 x 1. 0 x 4.6..9.0
 Base.....2. 4 x 1. 4 x 0.8..2.1
 B. Base.....2.10 x 1.10 x 1.2..6.1
 Weight complete 2800 lbs.; no B.B.1705 lbs.
 C.....\$260.00
 D.....236.00
 F.....224.00
 G.....219.00
 H.....213.00
 I.....208.00
 K.....200.00
 L.....191.00
 If B. B. is omitted deduct \$21.30
 Hone finished

No. 4702¹/₄

Die.....1.6 x 0. 4 x 2. 0..1.0
 B. Base.....2.0 x 0.10 x 0.10..1.5
 Weight complete 425 lbs.; no B. B. 170 lbs.
 C.....\$27.50
 D.....25.25
 F.....24.25
 G.....23.75
 H.....23.25
 I.....22.75
 K.....22.00
 L.....21.50
 If B. B. is omitted deduct \$5.10

No. 4703¹/₄

Die.....1.8 x 0.10 x 4.0..5.7
 Base.....2.0 x 1. 2 x 0.8..1.7
 B. Base.....2.6 x 1. 8 x 1.0..4.2
 Weight complete 1900 lbs.; no B.B.1150 lbs.
 C.....\$199.00
 D.....183.00
 F.....175.00
 G.....172.00
 H.....168.00
 I.....165.00
 K.....159.00
 L.....154.00
 If B. B. is omitted deduct \$14.60
 Hone finished

No. 4703¹/₂

See next page

No. 4705

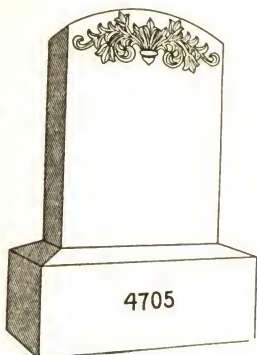

Die.....1.6 x 0.6 x 2. 0..1.6
 B. Base.....2.0 x 1.0 x 0.10..1.8

Weight complete 550 lbs.; no B. B. 250 lbs.

C.....	\$35.00
D.....	31.50
F.....	30.00
G.....	29.25
H.....	28.50
I.....	27.75
K.....	26.50
L.....	25.50

If B. B. is omitted deduct \$6.00

No. 4705¹/₄

Die.....1.6 x 0. 4 x 2. 0..1.0
 B. Base....2.0 x 0.10 x 0.10..1.5

Weight complete 425 lbs.; no B. B. 170 lbs.

C.....	\$27.50
D.....	25.25
F.....	24.25
G.....	23.75
H.....	23.25
I.....	22.75
K.....	22.00
L.....	21.25

If B. B. is omitted deduct 5.10

No. 4710

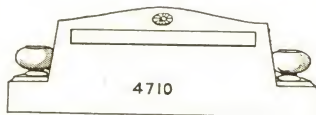

Die....5.10 x 1.0 x 2.0 ..11. 8
 2 Vases.0. 9¹/₂ x 0.9¹/₂ x 0.6⁷/₈.. 0.10

Weight complete 1800 lbs.

C.....	\$229.00
D.....	201.00
F.....	189.00
G.....	183.00
H.....	176.00
I.....	170.00
K.....	161.00
L.....	151.00

Hone finished

No. 4703¹/₂

Die.....1. 6 x 0.8 x 3.10 ..3.10
 Base.....1.10 x 1.0 x 0. 8..1. 3
 B. Base....2. 4 x 1.6 x 1. 0..3. 6

Weight complete 1450 lbs.; no B. B. 820 lbs.

C.....	\$151.00
D.....	140.00
F.....	134.00
G.....	132.00
H.....	129.00
I.....	127.00
K.....	123.00
L.....	119.00

If B. B. is omitted deduct \$12.25
 Hone finished

No. 4716

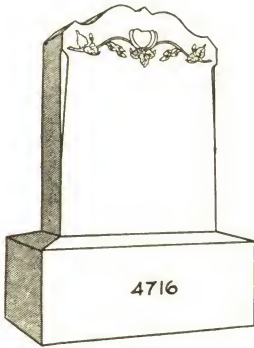

Die.....1.6 x 0.6 x 2. 0..1.6
 B. Base.....2.0 x 1.0 x 0.10..1.8

Weight complete 550 lbs.; no B. B. 250 lbs.

C.....	\$34.75
D.....	31.25
F.....	29.75
G.....	29.00
H.....	28.25
I.....	27.50
K.....	26.25
L.....	25.25

If B. B. is omitted deduct \$6.00

No. 4717

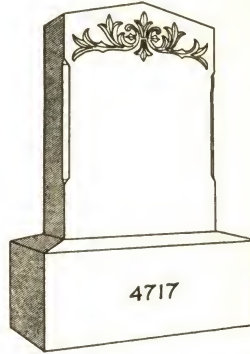

Die.....1.6 x 0.6 x 2. 0..1.6
 B. Base.....2.0 x 1.0 x 0.10..1.8

Weight complete 550 lbs.; no B.B. 250 lbs.

C.....	\$34.75
D.....	31.25
F.....	29.75
G.....	29.00
H.....	28.25
I.....	27.50
K.....	26.25
L.....	25.25

If B. B. is omitted deduct \$6.00

No. 4716¹/₄

Die.....1.6 x 0. 4 x 2. 0..1.0
 B. Base.....2.0 x 0.10 x 0.10..1.5

Weight complete 425 lbs.; no B. B. 170 lbs.

C.....	\$27.00
D.....	24.75
F.....	23.75
G.....	23.25
H.....	22.75
I.....	22.25
K.....	21.50
L.....	20.75

If B. B. is omitted deduct \$5.10

No. 4717¹/₄

Die.....1.6 x 0. 4 x 2. 0..1.0
 B. Base.....2.0 x 0.10 x 0.10..1.5

Weight complete 425 lbs.; no B.B. 170 lbs.

C.....	\$27.00
D.....	24.75
F.....	23.75
G.....	23.25
H.....	22.75
I.....	22.25
K.....	21.50
L.....	20.75

If B. B. is omitted deduct \$5.10

No. 4724

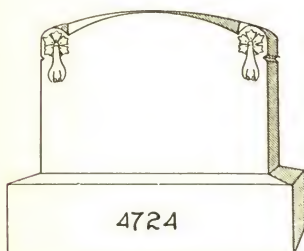

Die.....1.8 x 0.6 x 1.2..1.0
 B. Base.....2.0 x 0.10 x 0.8..1.1

Weight complete 375 lbs.; no B. B. 180 lbs.

C.....	\$22.25
D.....	20.00
F.....	19.00
G.....	18.50
H.....	18.00
I.....	17.50
K.....	16.75
L.....	16.00

If B. B. is omitted deduct \$3.90

No. 4724¹/₄

Die.....1.6 x 0.6 x 1.0..0.9
 B. Base.....1.10 x 0.10 x 0.8..1.0

Weight complete 315 lbs.; no B. B. 135 lbs.

C.....	\$18.50
D.....	17.00
F.....	16.00
G.....	15.75
H.....	15.25
I.....	15.00
K.....	14.50
L.....	13.75

If B. B. is omitted deduct \$3.75

No. 4724¹/₂

Die.....1.4 x 0.4 x 1.0..0.5
 B. Base.....1.8 x 0.8 x 0.8..0.9

Weight complete 210 lbs.; no B. B. 75 lbs.

C.....	\$12.50
D.....	11.50
F.....	11.25
G.....	11.00
H.....	10.75
I.....	10.50
K.....	10.00
L.....	9.75

If B. B. is omitted deduct \$2.80

No. 4727

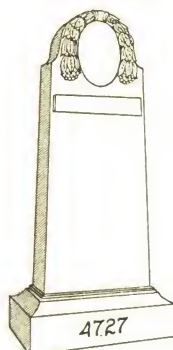

Die.....2.5 x 1.0 x 5.10..14.1
 Base.....3.2 x 1.9 x 1.0..5.7

Weight complete 3200 lbs.

C.....	\$332.00
D.....	288.00
F.....	268.00
G.....	258.00
H.....	249.00
I.....	239.00
K.....	224.00
L.....	209.00

No. 4727¹/₄

Die.....2.3 x 0.10 x 5.8..10.8
 Base.....3.0 x 1.7 x 1.0..4.9

Weight complete 2600 lbs.

C.....	\$272.00
D.....	238.00
F.....	222.00
G.....	215.00
H.....	207.00
I.....	199.00
K.....	188.00
L.....	176.00

No. 4727¹/₂

Die.....2.1 x 0.8 x 5.6..7.8
 Base.....2.8 x 1.3 x 0.10..2.9

Weight complete 1700 lbs.

C.....	\$202.00
D.....	178.00
F.....	168.00
G.....	163.00
H.....	157.00
I.....	152.00
K.....	144.00
L.....	136.00

No. 4728

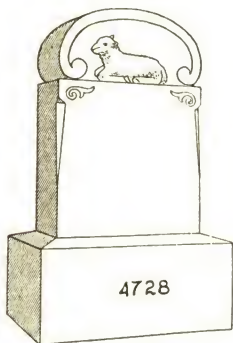

Die.....1.2 x 0.6 x 1.8..1.0
 B. Base....1.6 x 0.10 x 0.8..0.10
 Weight complete 325 lbs.; no B. B. 175 lbs.

C.....	\$28.25
D.....	26.00
F.....	25.00
G.....	24.50
H.....	24.00
I.....	23.50
K.....	22.75
L.....	22.00

If B. B. is omitted deduct \$3.15

No. 4729

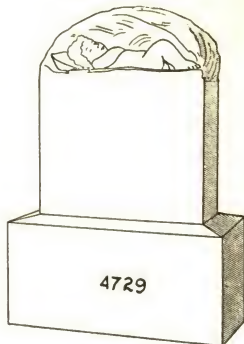

Die.....1.4 x 0.6 x 1.8..1.1
 B. Base....1.8 x 0.10 x 0.10..1.2
 Weight complete 375 lbs.; no B. B. 165 lbs.

C.....	\$49.50
D.....	47.00
F.....	46.00
G.....	45.50
H.....	44.75
I.....	44.25
K.....	43.50
L.....	42.75

If B. B. is omitted deduct \$4.20

No. 4730—B

No. 4728¹/₄

Die.....1.0 x 0.6 x 1.6..0.9
 B. Base....1.4 x 0.10 x 0.8..0.9
 Weight complete 270 lbs.; no B. B. 135 lbs.

C.....	\$22.75
D.....	21.25
F.....	20.25
G.....	20.00
H.....	19.50
I.....	19.25
K.....	18.75
L.....	18.00

If B. B. is omitted deduct \$2.80

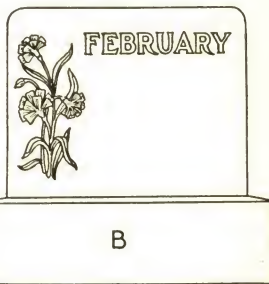

Sizes and prices same as No. 4730—A.
No. 4730—C

No. 4728¹/₂

Die.....1.0 x 0.4 x 1.6..0.6
 B. Base....1.4 x 0.8 x 0.8..0.7
 Weight complete 195 lbs.; no B. B. 90 lbs.

C.....	\$18.75
D.....	17.50
F.....	17.00
G.....	16.75
H.....	16.50
I.....	16.25
K.....	15.75
L.....	15.50

If B. B. is omitted deduct \$2.20

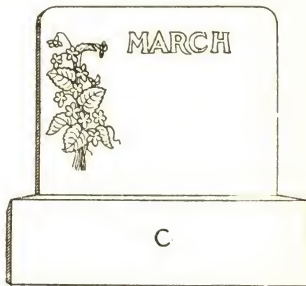

Sizes and prices same as No. 4730—A.
No. 4730—A
 See next page

No. 4730—A

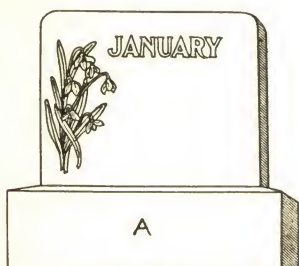

Die.....1. 6 x 0.4 x 1.2..0.7
 B. Base.....1.10 x 0.8 x 0.6..0.7

Weight complete 210 lbs.; no B. B. 100 lbs.

- C.....\$15.00
- D.....13.75
- F.....13.25
- G.....13.00
- H.....12.50
- I.....12.25
- K.....12.00
- L.....11.50

If B. B. is omitted deduct \$2.20

No. 4730—D.

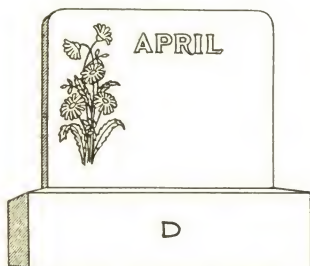

Sizes and prices same as No. 4730—A.

No. 4730—E

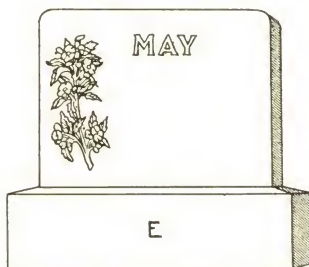

Sizes and prices same as No. 4730—A.

No. 4730—F

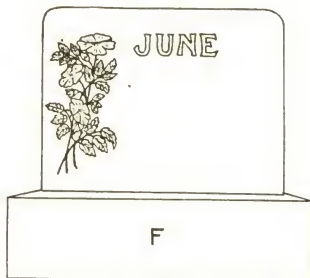

Sizes and prices same as No. 4730—A.

No. 4730¹/₄—A

Die.....1.4 x 0.4 x 1.0..0.5
 B. Base.....1.8 x 0.8 x 0.6..0.7

Weight complete 180 lbs.; no B. B. 75 lbs.

- C.....\$12.75
- D.....\$11.75
- F.....11.50
- G.....11.25
- H.....11.00
- I.....10.75
- K.....10.25
- L.....10.00

If B. B. is omitted deduct \$2.20

No. 4730—G

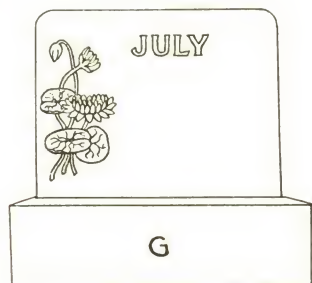

Sizes and prices same as No. 4730-A.

No. 4730—K

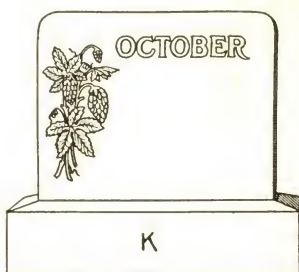

Sizes and prices same as No. 4730-A.

No. 4730—H



Sizes and prices same as No. 4730-A.

No. 4730—L

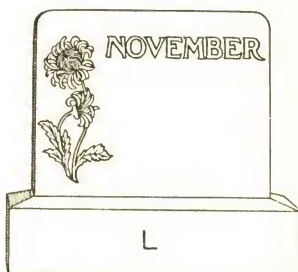

Sizes and prices same as No. 4730-A.

No. 4730—J



Sizes and prices same as No. 4730-A.

No. 4730—M



Sizes and prices same as No. 4730-A.

No. 4745

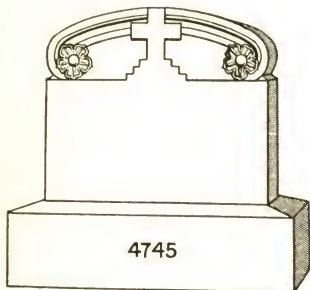

Die.....1. 6 x 0. 6 x 1.4..1.0
 B. Base....1.10 x 0.10 x 0.8..1.0
 Weight complete 325 lbs.; no B. B. 145 lbs.

- C.....\$31.75
- D.....29.50
- F.....28.50
- G.....28.00
- H.....27.50
- I.....27.00
- K.....26.25
- L.....25.50

If B. B. is omitted deduct \$3.75

No. 4745¹/₄

Die.....1.4 x 0.5 x 1.2..0.8
 B. Base....1.8 x 0.9 x 0.6..0.8
 Weight complete 225 lbs.; no B. B. 105 lbs.

- C.....\$24.25
- D.....22.75
- F.....22.25
- G.....21.75
- H.....21.50
- I.....21.25
- K.....20.75
- L.....20.25

If B. B. is omitted deduct \$2.50

No. 4745¹/₂

Die.....1.4 x 0.4 x 1.2..0.6
 B. Base....1.8 x 0.8 x 0.6..0.7
 Weight complete 180 lbs.; no B. B. 75 lbs.

- C.....\$20.00
- D.....18.75
- F.....18.25
- G.....18.00
- H.....17.75
- I.....17.50
- K.....17.00
- L.....16.75

If B. B. is omitted deduct \$2.20

No. 4749

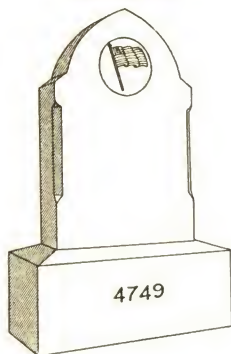

Die.....1.6 x 0.6 x 2. 4..1.9
 B. Base....2.0 x 1.0 x 0.10..1.8
 Weight complete 575 lbs.; no B. B. 275 lbs.

Rutland White,
 Riv., S. F., Blue
 or P. V.....\$19.00

If B. B. is omitted deduct \$6.00
 All sand finished

No. 4749¹/₄

Die.....1. 4 x 0. 4 x 2. 6..1.1
 B. Base....1.10 x 0.10 x 0.10..1.3
 Weight complete 400 lbs.; no B. B. 175 lbs.

Rutland White,
 Riv., S. F., Blue
 or P. V.....\$12.50

If B. B. is omitted deduct \$4.50
 All sand finished

No. 4762

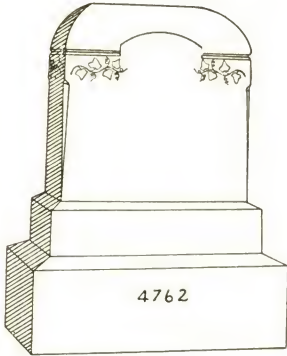

Die.....2. 6 x 1. 0 x 2.6..6.3
 Base.....2.10 x 1. 4 x 0.8..2.6
 B. Base....3. 4 x 1.10 x 1.2..7.2
 Weight complete 2800 lbs.; no B.B.1510 lbs.

C.....\$168.00
 D.....148.00
 F.....140.00
 G.....135.00
 H.....131.00
 I.....127.00
 K.....120.00
 L.....113.00
 If B. B. is omitted deduct \$25.10

No. 4762¹/₄

Die.....2.4 x 0.10 x 2.4..4.6
 Base.....2.8 x 1. 2 x 0.8..2.1
 B. Base....3.2 x 1. 8 x 1.2..6.2
 Weight complete 2200 lbs.; no B.B.1090 lbs.

C.....\$131.00
 D.....116.00
 F.....110.00
 G.....106.00
 H.....103.00
 I.....100.00
 K.....95.00
 L.....90.00
 If B. B. is omitted deduct \$21.60

No. 4762¹/₂

Die.....2.2 x 0.8 x 2.2..3.2
 Base.....2.6 x 1.0 x 0.8..1.8
 B. Base....3.0 x 1.6 x 1.0..4.6
 Weight complete 1550 lbs.; no B. B. 740 lbs.

C.....\$101.00
 D.....90.50
 F.....85.50
 G.....83.00
 H.....81.00
 I.....78.50
 K.....74.50
 L.....71.00
 If B. B. is omitted deduct \$15.75

No. 4763

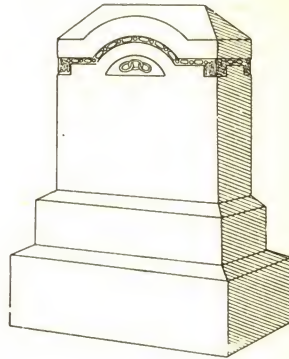

Die.....2. 6 x 1. 0 x 2.6..6.3
 Base.....2.10 x 1. 4 x 0.8..2.6
 B. Base....3. 4 x 1.10 x 1.2..7.2
 Weight complete 2800 lbs.; no B.B.1510 lbs.

D.....\$162.00
 G.....149.00
 H.....145.00
 I.....141.00
 K.....134.00
 L.....127.00

If B. B. is omitted deduct \$25.10
 If emblem is omitted deduct \$3.00.
 Specify on order in all cases whether emblem is wanted.

No. 4763¹/₄

Die.....2.4 x 0.10 x 2.4..4.6
 Base.....2.8 x 1. 2 x 0.8..2.1
 B. Base....3.2 x 1. 8 x 1.0..5.3
 Weight complete 2000 lbs.; no B.B.1055 lbs.

D.....\$127.00
 G.....117.00
 H.....114.00
 I.....111.00
 K.....106.00
 L.....101.00

If B. B. is omitted deduct \$18.40
 If emblem is omitted deduct \$3.00.
 Specify on order in all cases whether emblem is wanted.

No. 4763¹/₂

Die.....2.0 x 0.8 x 2.0..2.8
 Base.....2.4 x 1.0 x 0.8..1.7
 B. Base....2.9 x 1.5 x 1.0..3.11
 Weight complete 1400 lbs.; no B. B. 700 lbs.

D.....\$90.00
 G.....84.00
 H.....81.50
 I.....79.50
 K.....76.50
 L.....73.00

If B. B. is omitted deduct \$13.70
 If emblem is omitted deduct \$3.00.
 Specify on order in all cases whether emblem is wanted.

No. 4764

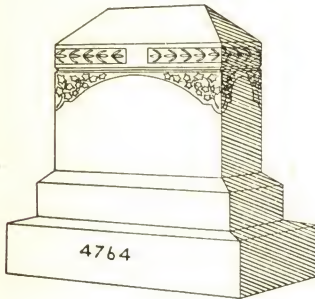

Die.....2. 6 x 1. 0 x 2.4 . . 5. 10
 Base.....2. 10 x 1. 4 x 0.8 . . 2. 6
 B. Base....3. 4 x 1.10 x 1.2 . . 7. 2
 Weight complete 2700 lbs.; no B.B. 1410 lbs.

- C.....\$157.00
- D.....138.00
- F.....130.00
- G.....126.00
- H.....122.00
- I.....117.00
- K.....111.00
- L.....105.00

If B. B. is omitted deduct \$25.10

No. 4764¹/₄

Die.....2.2 x 0.10 x 2.0 . . 3. 7
 Base.....2.6 x 1. 2 x 0.8 . . 1.11
 B. Base....3.0 x 1. 8 x 1.0 . . 5. 0
 Weight complete 1800 lbs.; no B. B. 900 lbs.

- C.....\$106.00
- D.....93.50
- F.....88.00
- G.....85.00
- H.....82.50
- I.....78.50
- K.....75.50
- L.....71.50

If B. B. is omitted deduct \$17.50

No. 4764¹/₂

Die.....2.0 x 0.8 x 1.10 . . 2. 5
 Base.....2.4 x 1.0 x 0. 8 . . 1. 7
 B. Base....2.9 x 1.5 x 1. 0 . . 3.11
 Weight complete 1300 lbs.; no B. B. 600 lbs.

- C.....\$82.00
- D.....73.00
- F.....69.00
- G.....67.00
- H.....65.00
- I.....63.00
- K.....60.00
- L.....57.00

If B. B. is omitted deduct \$13.70

No. 4768

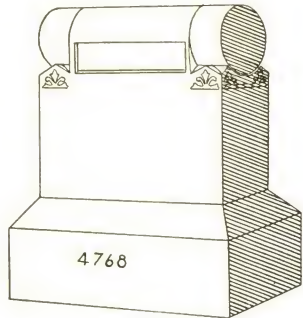

Die.....2.8 x 1. 2 x 2.8 . . 8.4
 B. Base....3.4 x 1.10 x 1.2 . . 7.2
 Weight complete 2625 lbs.; no B.B. 1330 lbs.

- C.....\$161.00
- D.....142.00
- F.....134.00
- G.....130.00
- H.....126.00
- I.....121.00
- K.....115.00
- L.....109.00

If B. B. is omitted deduct \$25.10

No. 4768¹/₄

Die.....2.6 x 1.0 x 2.6 . . 6.3
 B. Base....3.0 x 1.6 x 1.0 . . 4.6
 Weight complete 1825 lbs.; no B. B. 1000 lbs.

- C.....\$121.00
- D.....107.00
- F.....100.00
- G.....98.00
- H.....94.50
- I.....91.50
- K.....87.00
- L.....82.00

If B. B. is omitted deduct \$15.75

No. 4768¹/₂

Die.....2. 4 x 0.10 x 2.4 . . 4.6
 B. Base....2.10 x 1. 4 x 1.0 . . 3.9
 Weight complete 1475 lbs.; no B. B. 700 lbs.

- C.....\$91.50
- D.....81.50
- F.....77.00
- G.....74.50
- H.....72.50
- I.....70.00
- K.....66.50
- L.....63.50

If B. B. is omitted deduct \$13.15

No. 4771

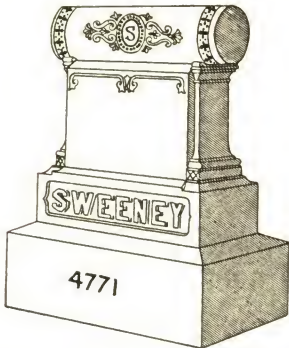

Roll.....	3. 2 x 1.2 x 1. 2. .4.4
Die.....	2.10 x 1.2 x 2. 4. .7.9
Base.....	3. 2 x 1.6 x 0.10. .4.0
B. Base....	3.10 x 2.2 x 1. 2. .9.8
Weight complete 4250 lbs.; no B.B.2510 lbs.	
C.....	\$311.00
D.....	275.00
F.....	259.00
G.....	251.00
H.....	243.00
I.....	235.00
K.....	223.00
L.....	211.00
If B. B. is omitted deduct \$33.85	

No. 4771¹/₄

Roll.....	3.0 x 1. 0 x 1.0. .3.0
Die.....	2.8 x 1. 0 x 2.2. .5.9
Base.....	3.0 x 1. 4 x 0.8. .2.8
B. Base....	3.6 x 1.10 x 1.2. .7.6
Weight complete 3100 lbs.; no B.B.1750 lbs.	
C.....	\$231.00
D.....	206.00
F.....	194.00
G.....	189.00
H.....	183.00
I.....	177.00
K.....	169.00
L.....	160.00
If B. B. is omitted deduct \$26.25	

No. 4771¹/₂

Roll.....	2.10 x 0.10 x 0.10. .2.0
Die.....	2. 6 x 0.10 x 2. 0. .4.2
Base.....	2.10 x 1. 2 x 0. 8. .2.2
B. Base....	3. 4 x 1. 8 x 1. 0. .5.7
Weight complete 2300 lbs.; no B.B.1300 lbs.	
C.....	\$176.00
D.....	157.00
F.....	149.00
G.....	145.00
H.....	141.00
I.....	136.00
K.....	130.00
L.....	124.00
If B. B. is omitted deduct \$19.55	

No. 4776

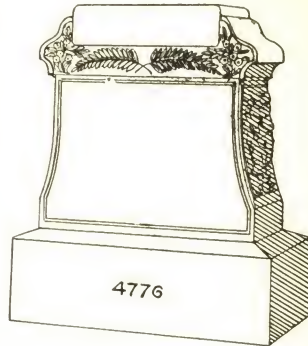

Die.....	2.6 x 1.0 x 2.6. .6.3
B. Base....	3.0 x 1.6 x 1.2. .5.3
Weight complete 1950 lbs.; no B.B.1005 lbs.	
C.....	\$123.00
D.....	109.00
F.....	102.00
G.....	100.00
H.....	96.50
I.....	93.50
K.....	89.00
L.....	84.00
If B. B. is omitted deduct \$18.40	

No. 4776¹/₄

Die.....	2. 4 x 0.10 x 2.4. .4.6
B. Base....	2.10 x 1. 4 x 1.0. .3.9
Weight complete 1380 lbs.; no B. B. 705 lbs.	
C.....	\$91.50
D.....	81.50
F.....	77.00
G.....	74.50
H.....	72.50
I.....	70.00
K.....	66.50
L.....	63.50
If B. B. is omitted deduct \$13.15	

No. 4776¹/₂

Die.....	2.2 x 0.8 x 2.2. .3.2
B. Base....	2.8 x 1.2 x 1.0. .3.1
Weight complete 1050 lbs.; no B. B. 495 lbs.	
C.....	\$67.50
D.....	60.50
F.....	57.50
G.....	56.00
H.....	54.50
I.....	52.50
K.....	50.50
L.....	48.00
If B. B. is omitted deduct \$10.80	

No. 4777

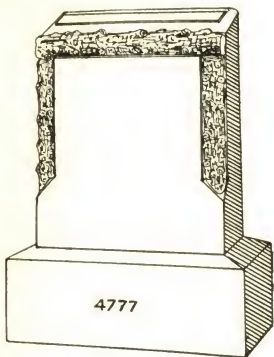

Die.....2.0 x 1.0 x 2.4..4.8
 B. Base.....2.6 x 1.6 x 1.0..3.9
 Weight complete 1475 lbs.; no B. B. 800 lbs.

C.....	\$100.00
D.....	90.00
F.....	85.00
G.....	83.00
H.....	80.50
I.....	78.00
K.....	74.50
L.....	71.00

If B. B. is omitted deduct \$13.15

No. 4781

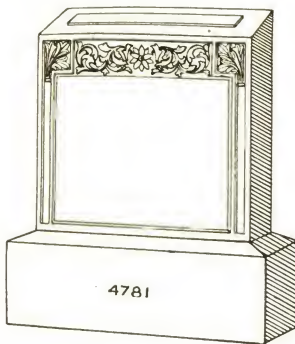

Die.....2.6 x 1.0 x 2.6..6.3
 B. Base.....3.0 x 1.6 x 1.2..5.3
 Weight complete 2000 lbs.; no B. B. 1055 lbs.

C.....	\$122.00
D.....	108.00
F.....	101.00
G.....	99.00
H.....	95.50
I.....	92.50
K.....	88.00
L.....	83.00

If B. B. is omitted deduct \$18.40

No. 4777¹/₄

Die.....2.0 x 0.10 x 2.4..3.11
 B. Base....2.6 x 1.4 x 1.0..3.4
 Weight complete 1275 lbs.; no B. B. 675 lbs.

C.....	\$85.50
D.....	76.50
F.....	72.50
G.....	70.50
H.....	68.50
I.....	66.50
K.....	63.50
L.....	61.00

If B. B. is omitted deduct \$11.65

No. 4781¹/₄

Die.....2.4 x 0.10 x 2.4..4.6
 B. Base....2.10 x 1.4 x 1.0..3.9
 Weight complete 1450 lbs.; no B. B. 775 lbs.

C.....	\$89.00
D.....	79.00
F.....	74.50
G.....	72.00
H.....	70.00
I.....	67.50
K.....	64.00
L.....	61.00

If B. B. is omitted deduct \$13.15

No. 4777¹/₂

Die.....1.10 x 0.8 x 2.2..2.8
 B. Base....2.4 x 1.2 x 0.10..2.3
 Weight complete 875 lbs.; no B. B. 470 lbs.

C.....	\$60.50
D.....	54.50
F.....	51.50
G.....	50.50
H.....	49.00
I.....	47.75
K.....	45.75
L.....	43.75

If B. B. is omitted deduct \$8.10

No. 4781¹/₂

Die.....2.2 x 0.8 x 2.2..3.2
 B. Base....2.8 x 1.2 x 1.0..3.1
 Weight complete 1100 lbs.; no B. B. 545 lbs.

C.....	\$68.50
D.....	61.50
F.....	58.50
G.....	57.00
H.....	55.50
I.....	53.50
K.....	51.50
L.....	49.00

If B. B. is omitted deduct \$10.80

No. 4797

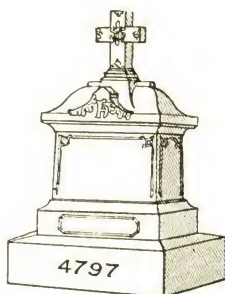

Cross.....1.2 x 0.6 x 1.10..1. 1
 Cap.....3.1 x 1.7 x 1. 0.4.11
 Die.....2.8 x 1.2 x 1. 8..5. 2
 Base.....3.0 x 1.6 x 0.10..3. 9
 B. Base....3.8 x 2.2 x 1. 2..9. 3

Weight complete 4000 lbs.; no B.B.2335 lbs.

C.....	\$292.00
D.....	258.00
F.....	244.00
G.....	236.00
H.....	229.00
I.....	221.00
K.....	210.00
L.....	199.00

If B. B. is omitted deduct \$32.40

No. 4798

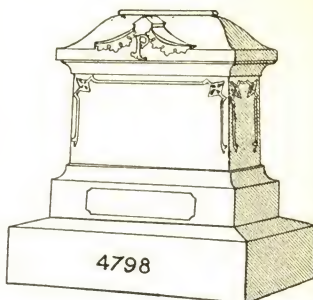

Cap.....3.1 x 1.7 x 1. 0.4.11
 Die.....2.8 x 1.2 x 1. 8..5. 2
 Base.....3.0 x 1.6 x 0.10..3. 9
 B. Base....3.8 x 2.2 x 1. 2..9. 3

Weight complete 3900 lbs.; no B.B.2235 lbs.

C.....	\$269.00
D.....	238.00
F.....	224.00
G.....	217.00
H.....	210.00
I.....	203.00
K.....	193.00
L.....	183.00

If B. B. is omitted deduct \$32.40

No. 4797¹/₄

Cross.....1. 2 x 0. 5 x 1.8..0.10
 Cap.....2.10 x 1. 4 x 1.0..3. 9
 Die.....2. 6 x 1. 0 x 1.6..3. 9
 Base.....2.10 x 1. 4 x 0.8..2. 6
 B. Base....3. 4 x 1.10 x 1.2..7. 2

Weight complete 3000 lbs.; no B.B.1710 lbs.

C.....	\$232.00
D.....	207.00
F.....	197.00
G.....	191.00
H.....	186.00
I.....	180.00
K.....	172.00
L.....	164.00

If B. B. is omitted deduct \$25.10

No. 4798¹/₄

Cap.....2.10 x 1. 4 x 1.0..3.9
 Die.....2. 6 x 1. 0 x 1.6..3.9
 Base.....2.10 x 1. 4 x 0.8..2.6
 B. Base....3. 4 x 1.10 x 1.2..7.2

Weight complete 2900 lbs.; no B.B.1610 lbs.

C.....	\$204.00
D.....	181.00
F.....	171.00
G.....	166.00
H.....	161.00
I.....	156.00
K.....	149.00
L.....	141.00

If B. B. is omitted deduct \$25.10

No. 4808

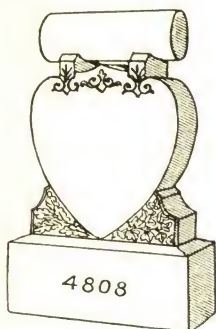

Roll.....2.0 x 1.0 x 1.0 .20
 Die.....2.2 x 1.0 x 2.6 .55
 B. Base.....2.8 x 1.6 x 1.2 .48

Weight complete 2000 lbs.; no B.B.1160 lbs.

- C.....\$145.00
- D.....129.00
- F.....121.00
- G.....118.00
- H.....114.00
- I.....110.00
- K.....105.00
- L.....99.00

If B. B. is omitted deduct \$16.35

No. 4808¹/₄

Roll.....1.10 x 0.10 x 0.10 .13
 Die.....2.0 x 0.10 x 2.4 .31
 B. Base...2.6 x 1.4 x 1.0 .34

Weight complete 1400 lbs.; no B. B.795 lbs.

- C.....\$107.00
- D.....95.00
- F.....90.00
- G.....87.50
- H.....85.00
- I.....82.00
- K.....78.50
- L.....74.50

If B. B. is omitted deduct \$11.65

No. 4808¹/₂

Roll.....1.8 x 0.8 x 0.8 .09
 Die.....1.10 x 0.8 x 2.2 .28
 B. Base...2.4 x 1.2 x 1.0 .29

Weight complete 1000 lbs.; no B. B.505 lbs.

- C.....\$79.00
- D.....71.00
- F.....68.00
- G.....66.00
- H.....64.50
- I.....62.50
- K.....60.00
- L.....57.50

If B. B. is omitted deduct \$9.90

No. 4810

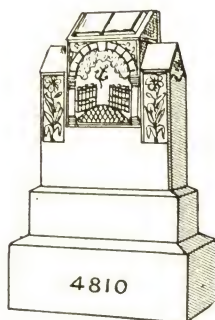

Die.....2.4 x 1.0 x 3.0 .70
 Base.....2.8 x 1.4 x 0.8 .24
 B. Base...3.2 x 1.10 x 1.2 .69

Weight complete 2750 lbs.; no B.B.1535 lbs.

- C.....\$175.00
- D.....154.00
- F.....144.00
- G.....140.00
- H.....135.00
- I.....130.00
- K.....123.00
- L.....116.00

If B. B. is omitted deduct \$23.65

No. 4810¹/₄

Die.....2.4 x 0.10 x 3.0 .51
 Base.....2.8 x 1.2 x 0.8 .21
 B. Base...3.2 x 1.8 x 1.0 .53

Weight complete 2250 lbs.; no B.B.1305 lbs.

- C.....\$148.00
- D.....130.00
- F.....122.00
- G.....118.00
- H.....114.00
- I.....110.00
- K.....104.00
- L.....98.50

If B. B. is omitted deduct \$18.40

No. 4810¹/₂

Die.....2.0 x 0.8 x 2.8 .37
 Base.....2.4 x 1.0 x 0.8 .17
 B. Base...2.10 x 1.6 x 1.0 .43

Weight complete 1600 lbs.; no B.B.835 lbs.

- C.....\$104.00
- D.....92.00
- F.....87.00
- G.....84.00
- H.....82.00
- I.....79.00
- K.....75.50
- L.....71.50

If B. B. is omitted deduct \$14.90

No. 4812

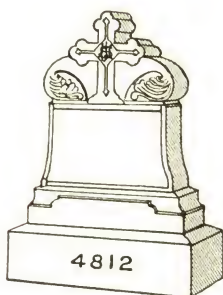

Die.....2. 6 x 1. 0 x 3.2. .7.11
 Base.....2.10 x 1. 4 x 0.8. .2. 6
 B. Base....3. 4 x 1.10 x 1.2. .7. 2
 Weight complete 2900 lbs.; no B.B.1610 lbs.

C.....\$215.00
 D.....191.00
 F.....181.00
 G.....176.00
 H.....170.00
 I.....165.00
 K.....157.00
 L.....150.00

If B. B. is omitted deduct \$25.10

No. 4812¹/₄

Die.....2. 6 x 0.10 x 3.2. .6.7
 Base.....2.10 x 1. 2 x 0.8. .2. 2
 B. Base....3. 4 x 1. 8 x 1.2. .6.6
 Weight complete 2500 lbs.; no B.B.1330 lbs.

C.....\$183.00
 D.....163.00
 F.....155.00
 G.....150.00
 H.....146.00
 I.....142.00
 K.....135.00
 L.....128.00

If B. B. is omitted deduct \$22.75

No. 4812¹/₂

Die.....2. 6 x 0.8 x 3.2. .5. 3
 Base.....2.10 x 1.0 x 0.8. .1.11
 B. Base....3. 4 x 1.6 x 1.0. .5. 0
 Weight complete 1950 lbs.; no B.B.1050 lbs.

C.....\$151.00
 D.....135.00
 F.....127.00
 G.....124.00
 H.....120.00
 I.....117.00
 K.....111.00
 L.....106.00

If B. B. is omitted deduct \$17.50

No. 4813

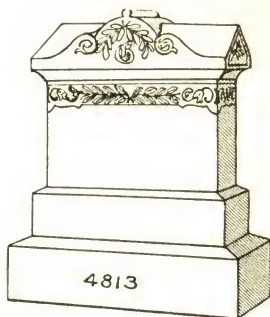

Cap.....3. 4 x 1.10 x 1. 2. .7. 2
 Die.....2.10 x 1. 4 x 1.10. .6.11
 Base.....3. 4 x 1.10 x 0.10. .5. 1
 B. Base....4. 0 x 2. 6 x 1. 2. .11. 8
 Weight complete 5300 lbs.; no B.B. 3200 lbs.

C.....\$341.00
 D.....298.00
 F.....278.00
 G.....269.00
 H.....259.00
 I.....250.00
 K.....235.00
 L.....221.00

If B. B. is omitted deduct \$40.85

No. 4813¹/₄

Cap.....3.1 x 1.7 x 1. 0. .4.11
 Die.....2.8 x 1.2 x 1. 8. .5. 2
 Base.....3.0 x 1.6 x 0.10. .3. 9
 B. Base....3.8 x 2.2 x 1. 2. .9. 3
 Weight complete 3800 lbs.; no B.B.2135 lbs.

C.....\$259.00
 D.....228.00
 F.....214.00
 G.....207.00
 H.....200.00
 I.....193.00
 K.....183.00
 L.....173.00

If B. B. is omitted deduct \$32.40

No. 4813¹/₂

Cap.....2.10 x 1. 4 x 1.0. .3.9
 Die.....2. 6 x 1. 0 x 1.6. .3.9
 Base.....2.10 x 1. 4 x 0.8. .2.6
 B. Base....3. 4 x 1.10 x 1.2. .7.2
 Weight complete 2900 lbs.; no B.B.1610 lbs.

C.....\$193.00
 D.....170.00
 F.....160.00
 G.....155.00
 H.....150.00
 I.....145.00
 K.....138.00
 L.....130.00

If B. B. is omitted deduct \$25.10

No. 4814



Die.....2. 6 x 1. 0 x 2.8..6.8
 Base.....2.10 x 1. 4 x 0.8..2.6
 B. Base....3. 4 x 1.10 x 1.2..7.2
 Weight complete 2900 lbs.; no B.B.1610 lbs.

C.....\$165.00
 D.....145.00
 F.....135.00
 G.....131.00
 H.....126.00
 I.....122.00
 K.....115.00
 L.....108.00

If B. B. is omitted deduct \$25.10

No. 4814 $\frac{1}{4}$

Die.....2.4 x 0.10 x 2.6..4.10
 Base.....2.8 x 1. 2 x 0.8..2. 1
 B. Base....3.2 x 1. 8 x 1.2..6. 2
 Weight complete 2250 lbs.; no B.B.1140 lbs.

C.....\$131.00
 D.....115.00
 F.....109.00
 G.....105.00
 H.....102.00
 I.....98.00
 K.....93.00
 L.....88.00

If B. B. is omitted deduct \$21.60

No. 4814 $\frac{1}{2}$

Die.....2.2 x 0.8 x 2.4..3.4
 Base.....2.6 x 1.0 x 0.8..1.8
 B. Base....3.0 x 1.6 x 1.0..4.6
 Weight complete 1650 lbs.; no B. B. 840 lbs.

C.....\$97.50
 D.....86.00
 F.....81.00
 G.....78.50
 H.....76.00
 I.....73.50
 K.....70.00
 L.....66.00

If B. B. is omitted deduct \$15.75

No. 4815

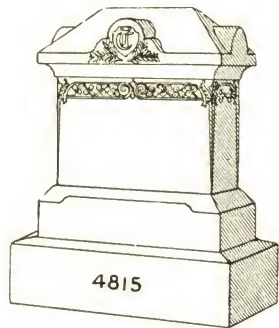

Cap.....3.6 x 1.10 x 1. 4.. 8.7
 Die.....3.0 x 1. 4 x 2. 0.. 8.0
 Base.....3.6 x 1.10 x 0.10.. 5.4
 B. Base....4.2 x 2. 6 x 1. 2..12.2
 Weight complete 5500 lbs.; no B.B.3310 lbs.

C.....\$384.00
 D.....335.00
 F.....313.00
 G.....302.00
 H.....291.00
 K.....280.00
 L.....264.00
 I.....247.00

If B. B. is omitted deduct \$42.60

No. 4815 $\frac{1}{4}$

Cap.....3. 4 x 1.8 x 1. 2.. 6. 6
 Die.....2.10 x 1.2 x 1.10.. 6. 1
 Base.....3. 4 x 1.8 x 0.10.. 4. 8
 B. Base....4. 0 x 2.4 x 1. 2..10.11
 Weight complete 4500 lbs.; no B.B.2535 lbs.

C.....\$315.00
 D.....277.00
 F.....259.00
 G.....251.00
 H.....242.00
 I.....234.00
 K.....221.00
 L.....208.00

If B. B. is omitted deduct \$38.20

No. 4815 $\frac{1}{2}$

Cap.....2.10 x 1. 4 x 1.0..3.9
 Die.....2. 6 x 1. 0 x 1.6..3.9
 Base.....2.10 x 1. 4 x 0.8..2.6
 B. Base....3. 4 x 1.10 x 1.2..7.2
 Weight complete 2750 lbs.; no B.B.1460 lbs.

C.....\$193.00
 D.....170.00
 F.....160.00
 G.....155.00
 H.....150.00
 I.....145.00
 K.....138.00
 L.....130.00

If B. B. is omitted deduct \$25.10

No. 4820

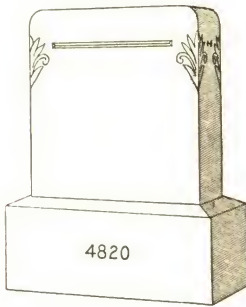

Die.....2.6 x 1.0 x 2.6..6.3
 B. Base.....3.0 x 1.6 x 1.2..5.3
 Weight complete 2050 lbs.; no B. B. 1105 lbs.

- C.....\$113.00
- D.....99.00
- F.....93.00
- G.....90.00
- H.....86.50
- I.....83.50
- K.....79.00
- L.....74.00

If B. B. is omitted deduct \$18.40

No. 4820¹/₄

Die.....2.4 x 0.10 x 2.4..4.6
 B. Base.....2.10 x 1.4 x 1.0..3.9
 Weight complete 1475 lbs.; no B. B. 805 lbs.

- C.....\$83.00
- D.....73.00
- F.....68.50
- G.....66.00
- H.....64.00
- I.....61.50
- K.....58.00
- L.....55.00

If B. B. is omitted deduct \$13.15

No. 4820¹/₂

Die.....2.0 x 0.8 x 2.0..2.8
 B. Base.....2.6 x 1.2 x 1.0..2.11
 Weight complete 1000 lbs.; no B. B. 475 lbs.

- C.....\$54.00
- D.....48.00
- F.....45.50
- G.....44.00
- H.....42.75
- I.....41.50
- K.....39.50
- L.....37.50

If B. B. is omitted deduct \$10.50

No. 4821

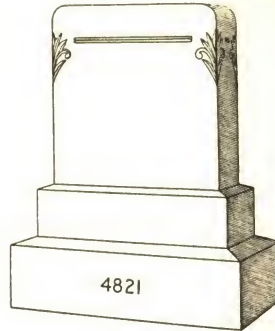

Die.....2.6 x 1.0 x 2.6..6.3
 Base.....2.10 x 1.4 x 0.8..2.6
 B. Base.....3.4 x 1.10 x 1.2..7.2
 Weight complete 2800 lbs.; no B. B. 1510 lbs.

- C.....\$155.00
- D.....135.00
- F.....127.00
- G.....122.00
- H.....118.00
- I.....114.00
- K.....107.00
- L.....100.00

If B. B. is omitted deduct \$25.10

No. 4821¹/₄

Die.....2.4 x 0.10 x 2.4..4.6
 Base.....2.8 x 1.2 x 0.8..2.1
 B. Base.....3.2 x 1.8 x 1.0..5.3
 Weight complete 2050 lbs.; no B. B. 1105 lbs.

- C.....\$118.00
- D.....103.00
- F.....96.00
- G.....93.00
- H.....89.50
- I.....86.50
- K.....81.50
- L.....76.50

If B. B. is omitted deduct \$18.40

No. 4821¹/₂

Die.....2.0 x 0.8 x 2.0..2.8
 Base.....2.4 x 1.0 x 0.8..1.7
 B. Base.....2.10 x 1.6 x 1.0..4.3
 Weight complete 1450 lbs.; no B. B. 685 lbs.

- C.....\$82.00
- D.....72.50
- F.....68.50
- G.....66.50
- H.....64.00
- I.....62.00
- K.....59.00
- L.....55.50

If B. B. is omitted deduct \$14.90

No. 4823

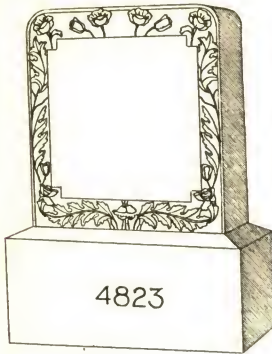

Die.....	2. 4 x 0.10 x 2.6.	.4.10
B. Base....	2.10 x 1. 4 x 1.2.	.4. 5
Weight complete 1650 lbs.; no B. B. 855 lbs.		
C.....		\$88.50
D.....		77.50
F.....		72.50
G.....		70.00
H.....		68.00
I.....		65.50
K.....		61.50
L.....		58.00
If B. B. is omitted deduct \$15.45		

No. 4823¹/₄

Die.....	2.2 x 0.8 x 2.4.	.3.4
B. Base....	2.8 x 1.2 x 1.0.	.3.1
Weight complete 1150 lbs.; no B. B. 595 lbs.		
C.....		\$63.00
D.....		55.50
F.....		52.50
G.....		50.50
H.....		49.00
I.....		47.25
K.....		44.75
L.....		42.25
If B. B. is omitted deduct \$10.80		

No. 4823¹/₂

Die.....	1.10 x 0.6 x 2. 0.	.1.10
B. Base....	2. 4 x 1.0 x 0.10.	.1.11
Weight complete 675 lbs.; no B. B. 330 lbs.		
C.....		\$38.00
D.....		34.00
F.....		32.00
G.....		31.25
H.....		30.25
I.....		29.25
K.....		28.00
L.....		26.50
If B. B. is omitted deduct \$6.90		

No. 4827

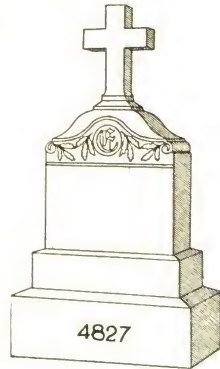

Cross.....	1. 2 x 0.6 x 1.10.	.1. 1
Die.....	2. 6 x 1.2 x 2. 8.	.7. 9
Base.....	2.10 x 1.6 x 0. 8.	.2.10
B. Base....	3. 6 x 2.2 x 1. 2.	.8.10
Weight complete 3500 lbs.; no B. B. 1910 lbs.		
C.....		\$231.00
D.....		205.00
F.....		193.00
G.....		187.00
H.....		182.00
I.....		176.00
K.....		167.00
L.....		158.00
If B. B. is omitted deduct \$30.90		

No. 4827¹/₄

Cross.....	1.2 x 0. 5 x 1.8.	.0.10
Die.....	2.4 x 1. 0 x 2.6.	.5.10
Base.....	2.8 x 1. 4 x 0.8.	.2. 4
B. Base....	3.2 x 1.10 x 1.2.	.6. 9
Weight complete 2650 lbs.; no B. B. 1435 lbs.		
C.....		\$183.00
D.....		163.00
F.....		154.00
G.....		149.00
H.....		145.00
I.....		140.00
K.....		133.00
L.....		127.00
If B. B. is omitted deduct \$23.65		

No. 4827¹/₂

Cross.....	1.0 x 0. 4 x 1.6.	.0. 6
Die.....	2.2 x 0.10 x 2.4.	.4. 3
Base.....	2.6 x 1. 2 x 0.8.	.1.11
B. Base....	3.0 x 1. 8 x 1.0.	.5. 0
Weight complete 2000 lbs.; no B. B. 1100 lbs.		
C.....		\$142.00
D.....		127.00
F.....		121.00
G.....		117.00
H.....		114.00
I.....		111.00
K.....		106.00
L.....		101.00
If B. B. is omitted deduct \$17.50		

No. 4860

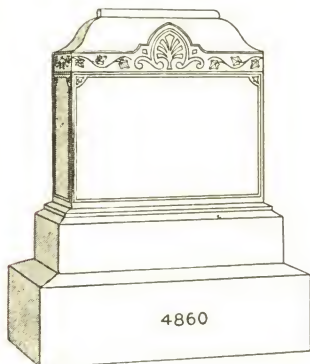

4860

Die.....2. 6 x 1. 0 x 2.6 .6.3
 Base.....2.10 x 1. 4 x 0.8 .2.6
 B. Base....3. 4 x 1.10 x 1.2 .7.2

Weight complete 2800 lbs.; no B.B.1510 lbs.

- C.....\$166.00
- D.....146.00
- F.....138.00
- G.....133.00
- H.....129.00
- I.....125.00
- K.....118.00
- L.....111.00

If B. B. is omitted deduct \$25.10

No. 4860¹/₄

Die.....2.4 x 0.10 x 2.4 .4.6
 Base.....2.8 x 1. 2 x 0.8 .2.1
 B. Base....3.2 x 1. 8 x 1.0 .5.3

Weight complete 2000 lbs.; no B.B.1055 lbs.

- C.....\$130.00
- D.....115.00
- F.....109.00
- G.....105.00
- H.....102.00
- I.....99.00
- K.....94.00
- L.....89.00

If B. B. is omitted deduct \$18.40

No. 4860¹/₂

Die.....2.2 x 0.8 x 2.2 .3.2
 Base.....2.6 x 1.0 x 0.8 .1.8
 B. Base....3.0 x 1.6 x 1.0 .4.6

Weight complete 1600 lbs.; no B. B. 790 lbs.

- C.....\$100.00
- D.....89.50
- F.....84.50
- G.....82.00
- H.....80.00
- I.....77.50
- K.....73.50
- L.....70.00

If B. B. is omitted deduct \$15.75

No. 4861

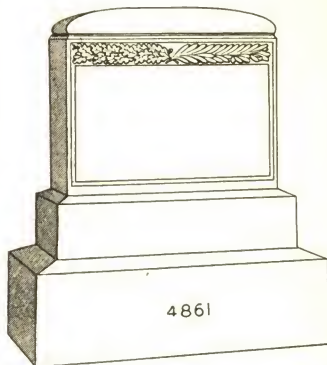

4861

Die.....2.8 x 1. 0 x 2.4 .6.3
 Base.....3.0 x 1. 4 x 0.8 .2.8
 B. Base....3.6 x 1.10 x 1.2 .7.6

Weight complete 2850 lbs.; no B.B.1500 lbs.

- C.....\$171.00
- D.....150.00
- F.....142.00
- G.....137.00
- H.....133.00
- I.....126.00
- K.....121.00
- L.....115.00

If B. B. is omitted deduct \$26.25

No. 4861¹/₄

Die.....2. 6 x 0.10 x 2.2 .4.6
 Base.....2.10 x 1. 2 x 0.8 .2.2
 B. Base....3. 4 x 1. 8 x 1.0 .5.7

Weight complete 2100 lbs.; no B.B.1095 lbs.

- C.....\$131.00
- D.....116.00
- F.....110.00
- G.....106.00
- H.....103.00
- I.....100.00
- K.....94.50
- L.....89.50

If B. B. is omitted deduct \$19.55

No. 4861¹/₂

Die.....2.4 x 0.8 x 2.0 .3.1
 Base.....2.8 x 1.0 x 0.8 .1.9
 B. Base....3.2 x 1.6 x 1.0 .4.9

Weight complete 1650 lbs.; no B. B. 795 lbs.

- C.....\$102.00
- D.....91.00
- F.....86.00
- G.....83.50
- H.....81.00
- I.....79.00
- K.....75.00
- L.....71.50

If B. B. is omitted deduct \$16.65

No. 4868



Die.....3.6 x 1.6 x 3.3..17.1
 Base.....4.2 x 2.2 x 1.0.* 9.0
 B. Base.....5.6 x 3.6 x 1.2..22.6

Weight complete 8400 lbs.; no B.B.4350 lbs.

- C.....\$562.00
- D.....503.00
- F.....477.00
- G.....464.00
- H.....451.00
- I.....438.00
- K.....418.00
- L.....399.00

If B. B. is omitted deduct \$78.75
 All sand finished

No. 4868 $\frac{1}{2}$

Die.....3.2 x 1.4 x 3.0..12.8
 Base.....3.8 x 1.10 x 1.0.. 6.9
 B. Base....4.6 x 2.8 x 1.2..14.0

Weight complete 5600 lbs.; no B.B.3080 lbs.

- C.....\$413.00
- D.....370.00
- F.....350.00
- G.....341.00
- H.....331.00
- I.....321.00
- K.....307.00
- L.....292.00

If B. B. is omitted deduct \$49.00
 All sand finished

No. 4869

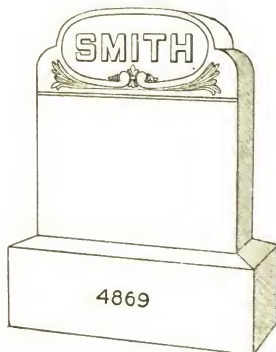

Die.....2.6 x 1.0 x 2.8..6.8
 B. Base.....3.0 x 1.6 x 1.2..5.3

Weight complete 2100 lbs.; no B.B.1155 lbs.

- C.....\$124.00
- D.....109.00
- F.....103.00
- G.....99.50
- H.....96.00
- I.....92.50
- K.....87.50
- L.....82.50

If B. B. is omitted deduct \$18.40

No. 4869 $\frac{1}{4}$

Die.....2.4 x 0.10 x 2.6..4.10
 B. Base...2.10 x 1.4 x 1.0..3.9

Weight complete 1500 lbs.; no B. B. 825 lbs.

- C.....\$91.00
- D.....80.00
- F.....75.00
- G.....72.50
- H.....70.50
- I.....68.00
- K.....64.00
- L.....60.50

If B. B. is omitted deduct \$13.15

No. 4869 $\frac{1}{2}$

Die.....2.2 x 0.8 x 2.4..3.4
 B. Base....2.8 x 1.2 x 1.0..3.1

Weight complete 1100 lbs.; no B.B. 545 lbs.

- C.....\$70.00
- D.....62.50
- F.....59.50
- G.....57.50
- H.....56.00
- I.....54.50
- K.....52.00
- L.....49.50

If B. B. is omitted deduct \$10.80

No. 4870

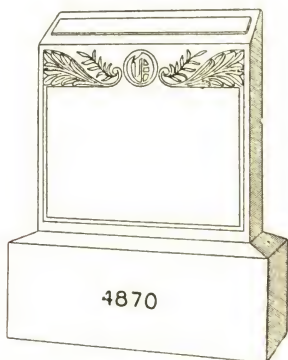

4870

Die.....2.6 x 0.10 x 2.6..5.3
 B. Base.....3.0 x 1.4 x 1.2..4.8

Weight complete 1750 lbs.; no B. B. 910 lbs.

C.....	\$102.00
D.....	90.50
F.....	85.50
G.....	83.00
H.....	80.00
I.....	77.50
K.....	73.50
L.....	69.50

If B. B. is omitted deduct \$16.35

No. 4873

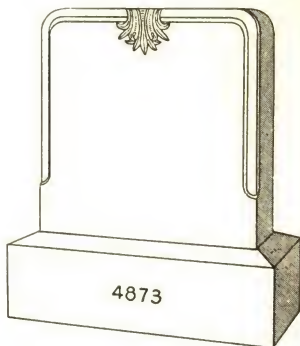

4873

Die.....2.4 x 0.10 x 2.4..4.6
 B. Base.....2.10 x 1.4 x 1.2..4.5

Weight complete 1600 lbs.; no B. B. 805 lbs.

C.....	\$92.50
D.....	82.50
F.....	78.00
G.....	76.00
H.....	73.50
I.....	71.00
K.....	67.50
L.....	64.50

If B. B. is omitted deduct \$15.45
 Back and edges polished

No. 4870¹/₄

Die.....2.4 x 0.8 x 2.4..3.8
 B. Base.....2.10 x 1.2 x 1.0..3.4

Weight complete 1200 lbs.; no B. B. 600 lbs.

C.....	\$76.00
D.....	68.00
F.....	64.00
G.....	62.50
H.....	60.50
I.....	58.50
K.....	56.00
L.....	53.00

If B. B. is omitted deduct \$11.65

No. 4873¹/₄

Die.....2.2 x 0.8 x 2.2..3.2
 B. Base.....2.8 x 1.2 x 1.0..3.1

Weight complete 1100 lbs.; no B. B. 545 lbs.

C.....	\$66.00
D.....	59.00
F.....	56.00
G.....	54.50
H.....	53.00
I.....	51.00
K.....	48.75
L.....	46.50

If B. B. is omitted deduct \$10.80
 Back and edges polished

No. 4870¹/₂

Die.....2.2 x 0.8 x 2.2..3.2
 B. Base.....2.8 x 1.2 x 1.0..3.1

Weight complete 1100 lbs.; no B. B. 545 lbs.

C.....	\$67.50
D.....	60.50
F.....	57.50
G.....	56.00
H.....	54.50
I.....	52.50
K.....	50.50
L.....	48.00

If B. B. is omitted deduct \$10.80

No. 4873¹/₂

Die.....2.0 x 0.6 x 2.0..2.0
 B. Base.....2.6 x 1.0 x 0.10..2.1

Weight complete 725 lbs.; no B. B. 350 lbs.

C.....	\$45.50
D.....	41.00
F.....	39.00
G.....	38.00
H.....	37.00
I.....	36.00
K.....	34.50
L.....	33.00

If B. B. is omitted deduct \$7.50
 Back and edges polished

No. 4879

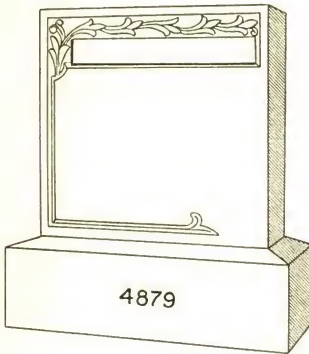

4879

Die.....2.6 x 1.0 x 2.6 .6.3
 B. Base.....3.0 x 1.6 x 1.2 .5.3
 Weight complete 2050 lbs.; no B. B. 1105 lbs.

D.....	\$102.00
G.....	92.50
H.....	89.00
I.....	86.00
K.....	81.50
L.....	76.50

If B. B. is omitted deduct \$18.40

No. 4879¹/₄

Die.....2.4 x 0.10 x 2.4 .4.6
 B. Base.....2.10 x 1.4 x 1.0 .3.9
 Weight complete 1450 lbs.; no B. B. 775 lbs.

D.....	\$76.50
G.....	69.50
H.....	67.50
I.....	65.00
K.....	61.50
L.....	58.50

If B. B. is omitted deduct \$13.15

No. 4879¹/₂

Die.....2.2 x 0.8 x 2.2 .3.2
 B. Base.....2.8 x 1.2 x 1.0 .3.1
 Weight complete 1100 lbs.; no B. B. 545 lbs.

D.....	\$60.50
G.....	56.00
H.....	54.50
I.....	52.50
K.....	50.50
L.....	49.00

If B. B. is omitted deduct \$10.80

No. 4879³/₄

Die.....2.0 x 0.8 x 2.0 .2.8
 B. Base.....2.6 x 1.2 x 1.0 .2.11
 Weight complete 1000 lbs.; no B. B. 475 lbs.

D.....	\$53.00
G.....	49.25
H.....	48.00
I.....	46.75
K.....	44.75
L.....	42.75

If B. B. is omitted deduct \$10.50

No. 4880



4880

Die.....2.8 x 0.10 x 2.10 .6.4
 B. Base.....3.2 x 1.4 x 1.0 .4.3
 Weight complete 1900 lbs.; no B. B. 1135 lbs.

D.....	\$98.00
G.....	88.50
H.....	85.50
I.....	82.50
K.....	77.50
L.....	73.00

If B. B. is omitted deduct \$14.90

No. 4880¹/₄

Die.....2.6 x 0.8 x 2.8 .4.5
 B. Base.....3.0 x 1.2 x 1.0 .3.6
 Weight complete 1400 lbs.; no B. B. 770 lbs.

D.....	\$73.50
G.....	67.00
H.....	65.00
I.....	62.50
K.....	59.50
L.....	56.00

If B. B. is omitted deduct \$12.25

No. 4880¹/₂

Die.....2.2 x 0.8 x 2.4 .3.4
 B. Base.....2.8 x 1.2 x 1.0 .3.1
 Weight complete 1150 lbs.; no B. B. 595 lbs.

D.....	\$60.50
G.....	55.50
H.....	54.00
I.....	52.50
K.....	49.75
L.....	47.25

If B. B. is omitted deduct \$10.80

No. 4880³/₄

Die.....2.0 x 0.6 x 2.2 .2.2
 B. Base.....2.6 x 1.0 x 0.10 .2.1
 Weight complete 750 lbs.; no B. B. 375 lbs.

D.....	\$42.25
G.....	39.00
H.....	38.00
I.....	37.00
K.....	35.25
L.....	33.75

If B. B. is omitted deduct \$7.50

No. 4882

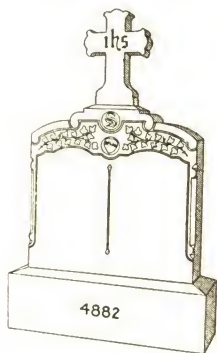

Cross.....1.2 x 0.4 x 1.8..0.8
 Die.....3.0 x 0.8 x 3.0..6.0
 B. Base.....3.6 x 1.2 x 1.0..4.1
 Weight complete 1850 lbs.; no B. B. 1115 lbs.

- C.....\$135.00
- D.....120.00
- F.....114.00
- G.....110.00
- H.....107.00
- I.....104.00
- K.....98.50
- L.....93.50

If B. B. is omitted deduct \$14.30
 Back plain polished

No. 4882¹/₄

Cross.....1.2 x 0.4 x 1.8..0.8
 Die.....2.8 x 0.8 x 2.8..4.9
 B. Base.....3.2 x 1.2 x 1.0..3.8
 Weight complete 1550 lbs.; no B. B. 890 lbs.

- C.....\$114.00
- D.....102.00
- F.....96.50
- G.....93.50
- H.....91.00
- I.....88.00
- K.....84.00
- L.....80.00

If B. B. is omitted deduct \$12.85
 Back plain polished

No. 4882¹/₂

Cross.....1.0 x 0.3 x 1.4..0.4
 Die.....2.4 x 0.6 x 2.4..2.9
 B. Base.....2.10 x 1.0 x 0.10..2.4
 Weight complete 925 lbs.; no B. B. 505 lbs.

- C.....\$75.50
- D.....68.50
- F.....65.50
- G.....64.00
- H.....62.50
- I.....61.00
- K.....58.50
- L.....56.00

If B. B. is omitted deduct \$8.40
 Back plain polished

No. 4893

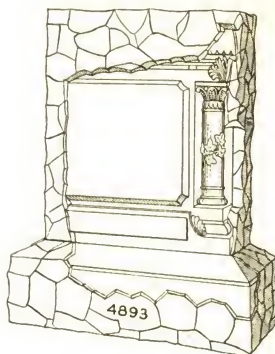

Die.....3.4 x 1.4 x 3.10..17.0
 B. Base.....4.4 x 2.4 x 1.4..13.6

Weight complete 5400 lbs.

Rutland White,
 Riv., S. F., Blue
 or P. V.....\$245.00

No. 4893¹/₄

Die.....3.2 x 1.2 x 3.8..13.7
 B. Base.....4.0 x 2.0 x 1.4..10.8

Weight complete 4300 lbs.

Rutland White,
 Riv., S. F., Blue
 or P. V.....\$198.00

No. 4893¹/₂

Die.....3.0 x 1.0 x 3.6..10.6
 B. Base.....3.8 x 1.8 x 1.2..7.2

Weight complete 3100 lbs.

Rutland White,
 Riv., S. F., Blue
 or P. V.....\$154.00

No. 4895

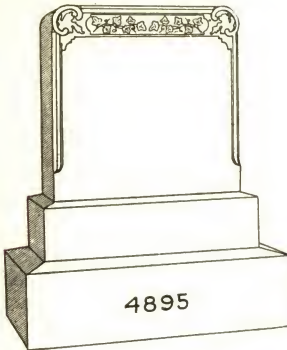

Die.....2. 6 x 1. 0 x 2.6 . 6.3
 Base.....2.10 x 1. 4 x 0.8 . 2.6
 B. Base.....3. 4 x 1.10 x 1.2 . 7.2
 Weight complete 2800 lbs.; no B.B.1510 lbs.

C.....	\$152.00
D.....	132.00
F.....	124.00
G.....	119.00
H.....	115.00
I.....	111.00
K.....	104.00
L.....	97.50

If B. B. is omitted deduct \$25.10

No. 4895¹/₄

Die.....2.4 x 0.10 x 2.4 . 4.6
 Base.....2.8 x 1. 2 x 0.8 . 2.1
 B. Base.....3.2 x 1. 8 x 1.0 . 5.3
 Weight complete 2000 lbs.; no B.B.1055 lbs.

C.....	\$116.00
D.....	101.00
F.....	94.00
G.....	91.00
H.....	87.50
I.....	84.50
K.....	79.50
L.....	74.50

If B. B. is omitted deduct \$18.40

No. 4895¹/₂

Die.....2.2 x 0.8 x 2.2 . 3.2
 Base.....2.6 x 1.0 x 0.8 . 1.8
 B. Base.....3.0 x 1.6 x 1.0 . 4.6
 Weight complete 1600 lbs.; no B. B. 790 lbs.

C.....	\$88.50
D.....	77.50
F.....	72.50
G.....	70.00
H.....	68.00
I.....	65.50
K.....	61.50
L.....	58.00

If B. B. is omitted deduct \$15.75

No. 4896



Die.....2.6 x 1.0 x 2.6 . 6.3
 B. Base.....3.0 x 1.6 x 1.2 . 5.3
 Weight complete 2000 lbs.; no B.B.1055 lbs.

C.....	\$111.00
D.....	97.00
F.....	91.00
G.....	87.50
H.....	84.50
I.....	81.50
K.....	76.50
L.....	72.00

If B. B. is omitted deduct \$18.40
 Face only polished, balance sand finished

No. 4896¹/₄

Die.....2. 4 x 0.10 x 2.4 . 4.6
 B. Base.....2.10 x 1. 4 x 1.0 . 3.9
 Weight complete 1475 lbs.; no B. B. 780 lbs.

C.....	\$82.00
D.....	72.00
F.....	67.50
G.....	65.00
H.....	63.00
I.....	60.50
K.....	57.00
L.....	54.00

If B. B. is omitted deduct \$13.15
 Face only polished; balance sand finished

No. 4896¹/₂

Die.....2.0 x 0.8 x 2.0 . 2. 8
 B. Base.....2.6 x 1.2 x 1.0 . 2.11
 Weight complete 1000 lbs.; no B. B. 475 lbs.

C.....	\$53.00
D.....	47.00
F.....	44.50
G.....	43.00
H.....	41.75
I.....	40.50
K.....	38.50
L.....	36.50

If B. B. is omitted deduct \$10.50
 Face only polished; balance sand finished

No. 4897

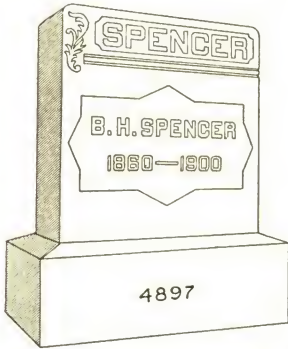

Die.....2.6 x 1.0 x 2.6 .6.3
 B. Base.....3.0 x 1.6 x 1.2 .5.3
 Weight complete 2000 lbs.; no B. B. 1055 lbs.

C.....	\$110.00
D.....	95.50
F.....	89.50
G.....	86.50
H.....	83.00
I.....	80.00
K.....	75.50
L.....	70.50

If B. B. is omitted deduct \$18.40
 Face only polished; balance sand finished

No. 4898

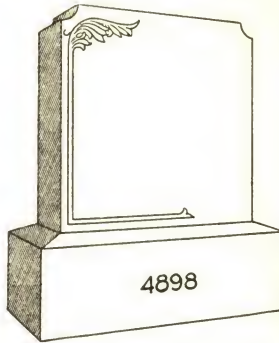

Die.....2.6 x 1.0 x 2.6 .6.3
 B. Base.....3.0 x 1.6 x 1.2 .5.3
 Weight complete 2000 lbs.; no B. B. 1055 lbs.

C.....	\$110.00
D.....	95.50
F.....	89.50
G.....	86.50
H.....	83.00
I.....	80.00
K.....	75.50
L.....	70.50

If B. B. is omitted deduct \$18.40
 Face only polished; balance sand finished

No. 4897¹/₄

Die.....2.4 x 0.10 x 2.4 .4.6
 B. Base.....2.10 x 1.4 x 1.0 .3.9
 Weight complete 1475 lbs.; no B. B. 780 lbs.

C.....	\$81.00
D.....	71.00
F.....	66.50
G.....	64.00
H.....	62.00
I.....	59.50
K.....	56.00
L.....	53.00

If B. B. is omitted deduct \$13.15
 Face only polished; balance sand finished

No. 4898¹/₄

Die.....2.4 x 0.10 x 2.4 .4.6
 B. Base.....2.10 x 1.4 x 1.0 .3.9
 Weight complete 1475 lbs.; no B. B. 780 lbs.

C.....	\$81.00
D.....	71.00
F.....	66.50
G.....	64.00
H.....	62.00
I.....	59.50
K.....	56.00
L.....	53.00

If B. B. is omitted deduct \$13.15
 Face only polished; balance sand finished

No. 4897¹/₂

Die.....2.0 x 0.8 x 2.0 .2.8
 B. Base.....2.6 x 1.2 x 1.0 .2.11
 Weight complete 1000 lbs.; no B. B. 475 lbs.

C.....	\$52.00
D.....	45.75
F.....	43.25
G.....	41.75
H.....	40.50
I.....	39.25
K.....	37.25
L.....	35.25

If B. B. is omitted deduct \$10.50
 Face only polished; balance sand finished

No. 4898¹/₂

Die.....2.0 x 0.8 x 2.0 .2.8
 B. Base.....2.6 x 1.2 x 1.0 .2.11
 Weight complete 1000 lbs.; no B. B. 475 lbs.

C.....	\$52.00
D.....	45.75
F.....	43.25
G.....	41.75
H.....	40.50
I.....	39.25
K.....	37.25
L.....	35.25

If B. B. is omitted deduct \$10.50
 Face only polished; balance sand finished

No. 4908

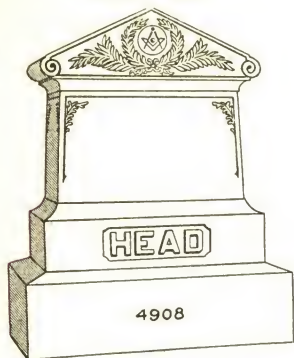

Cap. 3. 6 x 1.10 x 1. 2.. 7. 6
 Die. 2.10 x 1. 4 x 1.10.. 6.11
 Base. 3. 4 x 1.10 x 0.10.. 5. 1
 B. Base. . 4. 0 x 2. 6 x 1. 2.. 11. 8
 Weight complete 5200 lbs.; no B.B.3100 lbs.

D. \$297.00
 F. 277.00
 G. 268.00
 H. 258.00
 I. 248.00
 K. 233.00
 L. 219.00

If B. B. is omitted deduct \$40.85
 Back plain polished

No. 4908¹/₄

Cap. 3.2 x 1.6 x 1. 0.. 4.9
 Die. 2.8 x 1.2 x 1. 8.. 5.2
 Base. 3.0 x 1.6 x 0.10.. 3.9
 B. Base. . 3.8 x 2.2 x 1. 2.. 9.3
 Weight complete 3900 lbs.; no B.B.2235 lbs.

D. \$220.00
 F. 206.00
 G. 199.00
 H. 193.00
 I. 186.00
 K. 176.00
 L. 165.00

If B. B. is omitted deduct \$32.40
 Back plain polished

No. 4908¹/₂

Cap. 3. 0 x 1. 4 x 1.0.. 4.0
 Die. 2. 6 x 1. 0 x 1.6.. 3.9
 Base. 2.10 x 1. 4 x 0.8.. 2.6
 B. Base. . 3. 4 x 1.10 x 1.2.. 7.2
 Weight complete 2900 lbs.; no B.B.1610 lbs.

D. \$169.00
 F. 159.00
 G. 154.00
 H. 149.00
 I. 144.00
 K. 136.00
 L. 128.00

If B. B. is omitted deduct \$25.10
 Back plain polished

No. 4909



Die. 3.4 x 1.4 x 3.8.. 16.4
 B. Base. 4.2 x 2.2 x 1.4.. 12.0

Weight complete 4900 lbs.

Rutland White,
 Riv., S. F., Blue
 or P. V. \$217.00

Back cut rock

No. 4909¹/₄

Die. 3. 0 x 1.2 x 3.4.. 11. 8
 B. Base. . 3.10 x 2.0 x 1.2.. 8.11

Weight complete 3600 lbs.

Rutland White,
 Riv., S. F., Blue
 or P. V. \$172.00

Back cut rock

No. 4909¹/₂

Die. 2.10 x 1.0 x 3.2.. 9. 0
 B. Base. . 3. 6 x 1.8 x 1.2.. 6.10

Weight complete 2750 lbs.

Rutland White,
 Riv., S. F., Blue
 or P. V. \$144.00

Back cut rock

No. 4909³/₄

Die. 2.8 x 0.10 x 3.0.. 6.8
 B. Base. 3.4 x 1. 6 x 1.0.. 5.0

Weight complete 2000 lbs.

Rutland White,
 Riv., S. F., Blue
 or P. V. \$115.00

Back cut rock

No. 4910

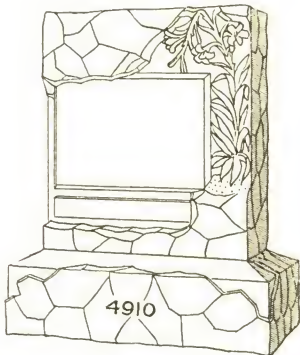

Die.....3.2 x 1.4 x 3.8..15.6
 B. Base.....4.2 x 2.4 x 1.4..13.0

Weight complete 5000 lbs.

Rutland White,
 Riv., S. F., Blue
 or P. V.....\$221.00

Back cut rock

No. 4910¹/₄

Die.....3.0 x 1.2 x 3.6..12.3
 B. Base.....3.10 x 2.0 x 1.2..8.11

Weight complete 3700 lbs.

Rutland White,
 Riv., S. F., Blue
 or P. V.....\$170.00

Back cut rock

No. 4910¹/₂

Die.....2.10 x 1.0 x 3.4..9.5
 B. Base.....3.6 x 1.8 x 1.2..6.10

Weight complete 2800 lbs.

Rutland White,
 Riv., S. F., Blue
 or P. V.....\$145.00

Back cut rock

No. 4910³/₄

Die.....2.8 x 0.10 x 3.2..7.0
 B. Base.....3.4 x 1.6 x 1.2..5.10

Weight complete 2200 lbs.

Rutland White,
 Riv., S. F., Blue
 or P. V.....\$125.00

Back cut rock

No. 4912

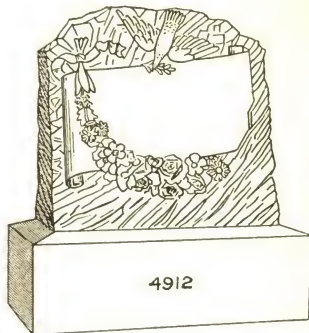

Die.....2.8 x 1.2 x 2.6..7.9
 B. Base.....3.2 x 1.8 x 1.2..6.2

Weight complete 2100 lbs.; no B. B. 990 lbs.

C.....\$219.00
 D.....192.00
 F.....184.00
 G.....180.00
 H.....176.00
 I.....173.00
 K.....167.00
 L.....161.00

If B. B. is omitted deduct \$21.60

No. 4912¹/₄

Die.....2.6 x 1.0 x 2.4..5.10
 B. Base.....3.0 x 1.6 x 1.0..4.6

Weight complete 1550 lbs.; no B. B. 740 lbs.

C.....\$165.00
 D.....152.00
 F.....146.00
 G.....143.00
 H.....140.00
 I.....137.00
 K.....133.00
 L.....129.00

If B. B. is omitted deduct \$15.75

No. 4912¹/₂

Die.....2.4 x 0.10 x 2.2..4.3
 B. Base.....2.10 x 1.4 x 1.0..3.9

Weight complete 1200 lbs.; no B. B. 525 lbs.

C.....\$140.00
 D.....130.00
 F.....126.00
 G.....124.00
 H.....122.00
 I.....120.00
 K.....116.00
 L.....113.00

If B. B. is omitted deduct \$13.15

No. 4914

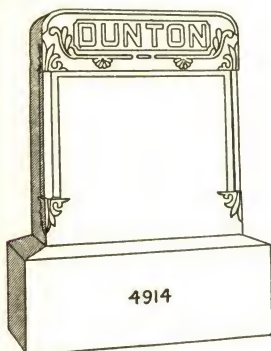

Die.....2.6 x 1.0 x 2.8..6.8
 B. Base.....3.0 x 1.6 x 1.2..5.3
 Weight complete 2100 lbs.; no B. B. 1155 lbs.

- C.....\$120.00
- D.....105.00
- F.....99.50
- G.....95.50
- H.....92.00
- I.....88.50
- K.....83.50
- L.....78.50

If B. B. is omitted deduct \$18.40
 Back polished

No. 4914¹/₄

Die.....2.4 x 0.10 x 2.6..4.10
 B. Base...2.10 x 1.4 x 1.0..3.9
 Weight complete 1500 lbs.; no B. B. 825 lbs.

- C.....\$89.50
- D.....78.50
- F.....73.50
- G.....71.00
- H.....69.00
- I.....66.50
- K.....62.50
- L.....59.00

If B. B. is omitted deduct \$13.15
 Back polished

No. 4914¹/₂

Die.....2.2 x 0.8 x 2.4..3.4
 B. Base.....2.8 x 1.2 x 1.0..3.1
 Weight complete 1125 lbs.; no B. B. 570 lbs.

- C.....\$67.50
- D.....60.00
- F.....57.00
- G.....55.00
- H.....53.50
- I.....52.00
- K.....49.25
- L.....46.75

If B. B. is omitted deduct \$10.80
 Back polished

No. 4915

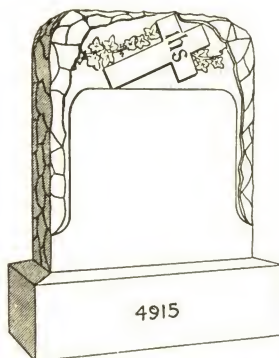

Die.....3.0 x 1.2 x 3.6..12.3
 B. Base....3.8 x 1.10 x 1.4..9.0
 Weight complete 3700 lbs.; no B. B. 2080 lbs.

Rutland White,
 Riv., S. F., Blue
 or P. V.....\$151.00
 If B. B. is omitted deduct \$31.50
 Back sand finished

No. 4915¹/₄

Die.....2.10 x 1.0 x 3.4..9.5
 B. Base....3.4 x 1.6 x 1.2..5.10
 Weight complete 2600 lbs.; no B. B. 1550 lbs.

Rutland White,
 Riv., S. F., Blue
 or P. V.....\$120.00
 If B. B. is omitted deduct \$20.40
 Back sand finished

No. 4915¹/₂

Die.....2.8 x 0.10 x 3.2..7.0
 B. Base....3.2 x 1.4 x 1.2..4.11
 Weight complete 2000 lbs.; no B. B. 1115 lbs.

Rutland White,
 Riv., S. F., Blue
 or P. V.....\$93.50
 If B. B. is omitted deduct \$17.20
 Back sand finished

No. 4915³/₄

Die.....2.6 x 0.8 x 2.10..4.9
 B. Base....3.0 x 1.2 x 1.0..3.6
 Weight complete 1400 lbs.; no B. B. 770 lbs.

Rutland White,
 Riv., S. F., Blue
 or P. V.....\$71.00
 If B. B. is omitted deduct \$12.25
 Back sand finished

No. 4917

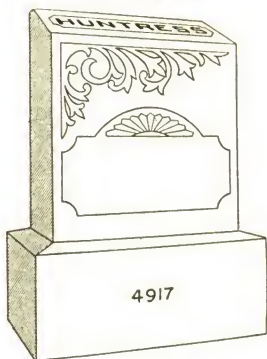

Die.....2. 4 x 1.2 x 2.8 .7 3
 B. Base.....2.10 x 1.8 x 1.2 .5 6
 Weight complete 2225 lbs.; no B.B.1235 lbs.

C.....	\$123.00
D.....	107.00
F.....	99.50
G.....	96.00
H.....	92.00
I.....	88.50
K.....	83.00
L.....	77.50

If B. B. is omitted deduct \$19.25
 Top, bevel and face polished; back and edges sand finished.

No. 4917¹/₄

Die.....2.2 x 1.0 x 2.6 .5 5
 B. Base.....2.8 x 1.6 x 1.2 .4 8
 Weight complete 1775 lbs.; no B. B. 935 lbs.

C.....	\$95.00
D.....	82.50
F.....	77.50
G.....	74.50
H.....	72.00
I.....	69.00
K.....	65.00
L.....	61.00

If B. B. is omitted deduct \$16.35
 Top, bevel and face polished; back and edges sand finished.

No. 4917¹/₂

Die.....2.0 x 0.10 x 2.4 .3 11
 B. Base.....2.6 x 1. 4 x 1.0 .3. 4
 Weight complete 1275 lbs.; no B. B. 670 lbs.

C.....	\$71.00
D.....	62.00
F.....	58.00
G.....	56.00
H.....	54.00
I.....	52.00
K.....	49.00
L.....	46.50

If B. B. is omitted deduct \$11.65
 Top, bevel and face polished; back and edges sand finished.

No. 4918

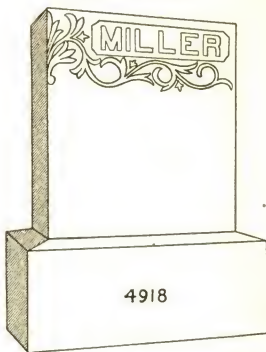

Die.....2. 4 x 1.2 x 2.8 .7 3
 B. Base.....2.10 x 1.8 x 1.2 .5 6
 Weight complete 2275 lbs.; no B.B.1285 lbs.

C.....	\$123.00
D.....	107.00
F.....	99.50
G.....	96.00
H.....	92.00
I.....	88.50
K.....	83.00
L.....	77.50

If B. B. is omitted deduct \$19.25
 Face polished; balance sand finished

No. 4918¹/₄

Die.....2.2 x 1.0 x 2.6 .5 5
 B. Base.....2.8 x 1.6 x 1.2 .4 8
 Weight complete 1800 lbs.; no B. B. 960 lbs.

C.....	\$95.00
D.....	82.50
F.....	77.50
G.....	74.50
H.....	72.00
I.....	69.00
K.....	65.00
L.....	61.00

If B. B. is omitted deduct \$16.35
 Face polished; balance sand finished

No. 4918¹/₂

Die.....2.0 x 0.10 x 2.4 .3 11
 B. Base.....2.6 x 1. 4 x 1.0 .3. 4
 Weight complete 1300 lbs.; no B. B. 695 lbs.

C.....	\$71.00
D.....	62.00
F.....	58.00
G.....	56.00
H.....	54.00
I.....	52.00
K.....	49.00
L.....	46.50

If B. B. is omitted deduct \$11.65
 Face polished; balance sand finished

No. 4919

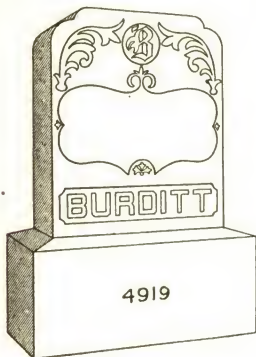

Die.....2. 4 x 1.2 x 2.8 .7.3
 B. Base.....2. 10 x 1.8 x 1.2 .5.6
 Weight complete 2225 lbs.; no B. B. 1235 lbs.

- C.....\$123.00
- D.....107.00
- F.....99.50
- G.....96.00
- H.....92.00
- I.....88.50
- K.....83.00
- L.....77.50

If B. B. is omitted deduct \$19.25
 Face polished; balance sand finished

No. 4919¹/₄

Die.....2.2 x 1.0 x 2.6 .5.5
 B. Base.....2.8 x 1.6 x 1.2 .4.8
 Weight complete 1775 lbs.; no B. B. 935 lbs.

- C.....\$95.00
- D.....82.50
- F.....77.50
- G.....74.50
- H.....72.00
- I.....69.00
- K.....65.00
- L.....61.00

If B. B. is omitted deduct \$16.35
 Face polished; balance sand finished

No. 4919¹/₂

Die.....2.0 x 0.10 x 2.4 .3.11
 B. Base.....2.6 x 1.4 x 1.0 .3.4
 Weight complete 1275 lbs.; no B. B. 670 lbs.

- C.....\$71.00
- D.....62.00
- F.....58.00
- G.....56.00
- H.....54.00
- I.....52.00
- K.....49.00
- L.....46.50

If B. B. is omitted deduct \$11.65
 Face polished; balance sand finished

No. 4923

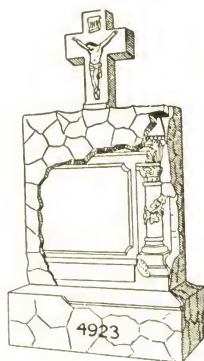

Cross.....1.6 x 0.8 x 2.4 .2.4
 Die.....3.4 x 1.4 x 3.10 .17.0
 B. Base.....4.4 x 2.4 x 1.4 .13.6

Weight complete 5600 lbs.

- Rutland White,
- Riv., S. F., Blue
- or P. V.....\$281.00

No. 4923¹/₄

Cross.....1.4 x 0.6 x 2.0 .1.4
 Die.....3.2 x 1.2 x 3.8 .13.7
 B. Base.....4.0 x 2.0 x 1.4 .10.8

Weight complete 4400 lbs.

- Rutland White,
- Riv., S. F., Blue
- or P. V.....\$229.00

No. 4923¹/₂

Cross.....1.4 x 0.6 x 1.10 .1.3
 Die.....3.0 x 1.0 x 3.6 .10.6
 B. Base.....3.8 x 1.8 x 1.2 .7.2

Weight complete 3200 lbs.

- Rutland White,
- Riv., S. F., Blue
- or P. V.....\$186.00

No. 4924

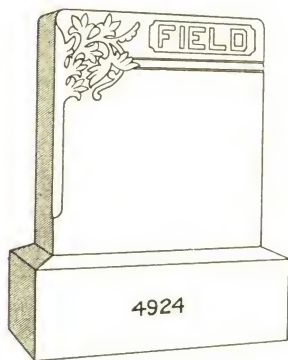

Die.....2.6 x 0.10 x 2.8..5.7
 B. Base.....3.0 x 1.4 x 1.2..4.8
 Weight complete 1800 lbs.; no B. B. 960 lbs.

C.....	\$103.00
D.....	91.00
F.....	85.00
G.....	82.50
H.....	79.50
I.....	77.00
K.....	72.50
L.....	68.50

If B. B. is omitted deduct \$16.35
 All polished

No. 4927

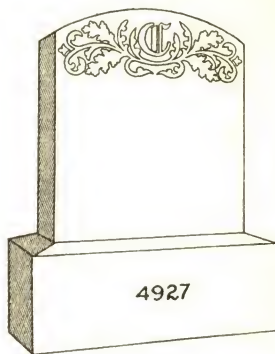

Die.....2.4 x 0.10 x 2.6..4.10
 B. Base.....2.10 x 1.4 x 1.2..4.5
 Weight complete 1600 lbs.; no B. B. 800 lbs.

C.....	\$90.00
D.....	79.00
F.....	74.00
G.....	71.50
H.....	69.50
I.....	67.00
K.....	63.00
L.....	59.50

If B. B. is omitted deduct \$15.45
 Face polished; balance sand finished

No. 4924¹/₄

Die.....2.4 x 0.8 x 2.6..3.11
 B. Base.....2.10 x 1.2 x 1.0..3.4
 Weight complete 1300 lbs.; no B. B. 700 lbs.

C.....	\$75.50
D.....	66.50
F.....	62.50
G.....	60.50
H.....	58.50
I.....	56.50
K.....	53.50
L.....	51.00

If B. B. is omitted deduct \$11.65
 All polished

No. 4927¹/₄

Die.....2.0 x 0.8 x 2.2..2.11
 B. Base.....2.6 x 1.2 x 1.0..2.11
 Weight complete 1025 lbs.; no B. B. 500 lbs.

C.....	\$58.50
D.....	52.00
F.....	49.00
G.....	47.50
H.....	46.00
I.....	44.75
K.....	42.50
L.....	40.25

If B. B. is omitted deduct \$10.50
 Face polished; balance sand finished

No. 4924¹/₂

Die.....2.0 x 0.6 x 2.2..2.2
 B. Base.....2.6 x 1.0 x 0.10..2.1
 Weight complete 750 lbs.; no B. B. 375 lbs.

C.....	\$46.00
D.....	41.00
F.....	39.00
G.....	37.75
H.....	36.75
I.....	35.75
K.....	34.00
L.....	32.50

If B. B. is omitted deduct \$7.50
 All polished

No. 4927¹/₂

Die.....1.6 x 0.8 x 1.8..1.8
 B. Base.....2.0 x 1.2 x 0.10..1.11
 Weight complete 625 lbs.; no B. B. 280 lbs.

C.....	\$35.00
D.....	31.25
F.....	29.75
G.....	28.75
H.....	28.00
I.....	27.25
K.....	26.00
L.....	24.75

If B. B. is omitted deduct \$6.90
 Face polished; balance sand finished

No. 4928

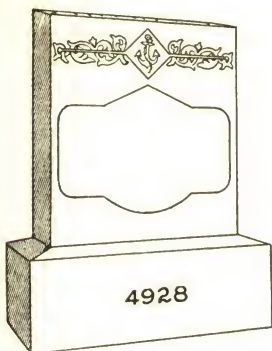

Die.....2. 4 x 0.10 x 2.8..5.2
 B. Base....2.10 x 1. 4 x 1.2..4.5
 Weight complete 1600 lbs.; no B. B. 800 lbs.

- C.....\$94.00
- D.....82.50
- F.....77.50
- G.....75.00
- H.....72.50
- I.....69.50
- K.....66.00
- L.....62.00

If B. B. is omitted deduct \$15.45
 Face and bevel polished; balance sand finished.

No. 4928¹/₄

Die.....2.0 x 0.8 x 2.4..3. 1
 B. Base....2.6 x 1.2 x 1.0..2.11
 Weight complete 1025 lbs.; no B. B. 500 lbs.

- C.....\$59.00
- D.....52.00
- F.....49.00
- G.....47.50
- H.....45.75
- I.....44.25
- K.....42.00
- L.....39.75

If B. B. is omitted deduct \$10.50
 Face and bevel polished; balance sand finished.

No. 4928¹/₂

Die.....1.6 x 0.8 x 1. 8..1. 8
 B. Base....2.0 x 1.2 x 0.10..1.11
 Weight complete 625 lbs.; no B. B. 280 lbs.

- C.....\$35.00
- D.....31.25
- F.....29.75
- G.....28.75
- H.....28.00
- I.....27.25
- K.....26.00
- L.....24.75

If B. B. is omitted deduct \$6.90
 Face and bevel polished; balance sand finished.

No. 4929

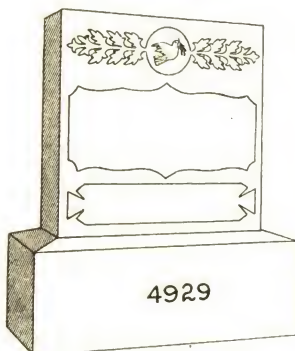

Die.....2. 4 x 0.10 x 2.4..4.6
 B. Base....2.10 x 1. 4 x 1.2..4.5
 Weight complete 1650 lbs.; no B. B. 855 lbs.

- C.....\$81.50
- D.....71.50
- F.....67.00
- G.....64.50
- H.....62.50
- I.....60.00
- K.....56.50
- L.....53.50

If B. B. is omitted deduct \$15.45
 Face polished; balance sand finished

No. 4929¹/₄

Die.....2.0 x 0.8 x 2.0..2. 8
 B. Base....2.6 x 1.2 x 1.0..2.11
 Weight complete 1000 lbs.; no B. B. 475 lbs.

- C.....\$52.00
- D.....45.75
- F.....43.25
- G.....41.75
- H.....40.50
- I.....39.25
- K.....37.25
- L.....35.25

If B. B. is omitted deduct \$10.50
 Face polished; balance sand finished

No. 4929¹/₂

Die.....1.6 x 0.8 x 1. 6..1. 6
 B. Base....2.0 x 1.2 x 0.10..1.11
 Weight complete 615 lbs.; no B. B. 270 lbs.

- C.....\$32.50
- D.....29.00
- F.....27.50
- G.....26.75
- H.....26.00
- I.....25.25
- K.....24.00
- L.....23.00

If B. B. is omitted deduct \$6.90
 Face polished; balance sand finished

No. 4931

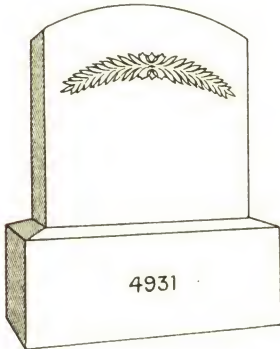

Die.....2.6 x 1.0 x 2.6 .6.3
 B. Base.....3.0 x 1.6 x 1.2 .5.3
 Weight complete 2000 lbs.; no B. B. 1055 lbs.

- C.....\$111.00
- D.....97.00
- F.....91.00
- G.....88.00
- H.....85.50
- I.....81.50
- K.....77.00
- L.....72.00

If B. B. is omitted deduct \$18.40
 Face polished; balance sand finished

No. 4931¹/₄

Die.....2.4 x 0.10 x 2.4 .4.6
 B. Base.....2.10 x 1.4 x 1.0 .3.9
 Weight complete 1475 lbs.; no B. B. 800 lbs.

- C.....\$82.50
- D.....70.50
- F.....68.00
- G.....65.50
- H.....63.50
- I.....61.00
- K.....57.50
- L.....54.50

If B. B. is omitted deduct \$13.15
 Face polished; balance sand finished

No. 4931¹/₂

Die.....2.0 x 0.8 x 2.0 .2.8
 B. Base.....2.6 x 1.2 x 1.0 .2.11
 Weight complete 975 lbs.; no B. B. 450 lbs.

- C.....\$53.00
- D.....47.00
- F.....44.50
- G.....43.00
- H.....41.75
- I.....40.50
- K.....38.50
- L.....36.50

If B. B. is omitted deduct \$10.50
 Face polished; balance sand finished

No. 4932

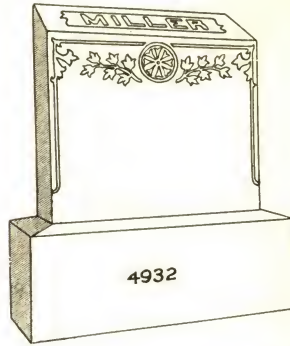

Die.....2.6 x 1.0 x 2.6 .6.3
 B. Base.....3.0 x 1.6 x 1.2 .5.3
 Weight complete 2000 lbs.; no B. B. 1055 lbs.

- C.....\$109.00
- D.....94.50
- F.....88.50
- G.....85.50
- H.....82.00
- I.....79.00
- K.....74.50
- L.....69.50

If B. B. is omitted deduct \$18.40
 Face and bevel polished; balance sand finished.

No. 4932¹/₄

Die.....2.4 x 0.10 x 2.4 .4.6
 B. Base.....2.10 x 1.4 x 1.0 .3.9
 Weight complete 1475 lbs.; no B. B. 800 lbs.

- C.....\$79.50
- D.....69.50
- F.....65.00
- G.....62.50
- H.....60.50
- I.....58.00
- K.....54.50
- L.....51.50

If B. B. is omitted deduct \$13.15
 Face and bevel polished; balance sand finished.

No. 4932¹/₂

Die.....2.0 x 0.8 x 2.0 .2.8
 B. Base.....2.6 x 1.2 x 1.0 .2.11
 Weight complete 975 lbs.; no B. B. 450 lbs.

- C.....\$49.50
- D.....43.50
- F.....41.00
- G.....39.50
- H.....38.25
- I.....37.00
- K.....35.00
- L.....33.00

If B. B. is omitted deduct \$10.50
 Face and bevel polished; balance sand finished.

No. 4933

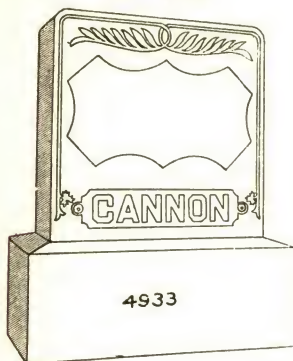

Die.....2.6 x 1.0 x 2.6..6.3
 B. Base.....3.0 x 1.6 x 1.2..5.3
 Weight complete 2050 lbs.; no B. B. 1105 lbs.

C.....	\$109.00
D.....	94.50
F.....	88.50
G.....	85.50
H.....	82.00
I.....	79.00
K.....	74.50
L.....	69.50

If B. B. is omitted deduct \$18.40
 Face polished; balance sand finished

No. 4933¹/₄

Die.....2.4 x 0.10 x 2.4..4.6
 B. Base....2.10 x 1.4 x 1.0..3.9
 Weight complete 1475 lbs.; no B. B. 800 lbs.

C.....	\$79.50
D.....	69.50
F.....	65.00
G.....	62.50
H.....	60.50
I.....	58.00
K.....	54.50
L.....	51.50

If B. B. is omitted deduct \$13.15
 Face polished; balance sand finished

No. 4933¹/₂

Die.....2.0 x 0.8 x 2.0..2.8
 B. Base....2.6 x 1.2 x 1.0..2.11
 Weight complete 1000 lbs.; no B. B. 475 lbs.

C.....	\$49.50
D.....	43.50
F.....	41.00
G.....	39.50
H.....	38.25
I.....	37.00
K.....	35.00
L.....	33.00

If B. B. is omitted deduct \$10.50
 Face polished; balance sand finished

No. 4935



Die.....3.0 x 1.4 x 3.4..13.4
 B. Base....3.10 x 2.2 x 1.4..11.1
 Weight complete 4200 lbs.

Rutland White,
 Riv., S. F., Blue
 or P. V.....\$197.00

No. 4935¹/₄

Die.....2.8 x 1.2 x 3.0..9.4
 B. Base....3.4 x 1.10 x 1.2..7.2
 Weight complete 2800 lbs.

Rutland White,
 Riv., S. F., Blue
 or P. V.....\$141.00

No. 4935¹/₂

Die.....2.6 x 1.0 x 2.10..7.1
 B. Base....3.0 x 1.6 x 1.0..4.6
 Weight complete 2000 lbs.

Rutland White,
 Riv., S. F., Blue
 or P. V.....\$125.00

No. 4939

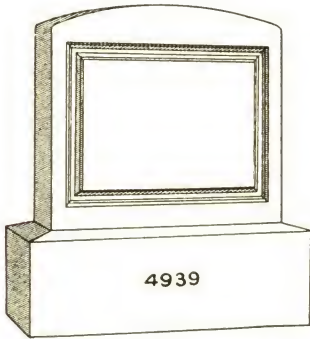

4939

Die.....2.8 x 0.10 x 2.4 .5.2
 B. Base.....3.2 x 1.4 x 1.0 .4.3
 Weight complete 1600 lbs.; no B. B. 835 lbs.

- D.....\$93.00
- H.....82.50
- L.....80.00
- K.....76.00
- L.....72.00

If B. B. is omitted deduct \$14.90
 Face of panel polished; balance sand finished.

No. 4947

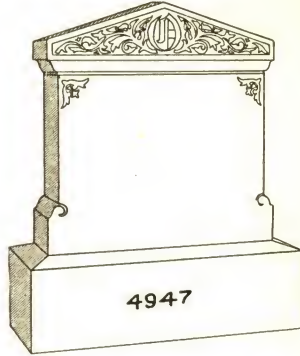

4947

Die.....2.10 x 0.10 x 2.10 .6.8
 B. Base....3.4 x 1.4 x 1.2 .5.2
 Weight complete 2000 lbs.; no B. B. 1070 lbs.

- C.....\$124.00
- D.....109.00
- F.....103.00
- G.....99.50
- H.....96.00
- I.....92.50
- K.....87.50
- L.....82.50

If B. B. is omitted deduct \$18.10

No. 4939¹/₄

Die.....2.6 x 0.8 x 2.2 .3.7
 B. Base.....3.0 x 1.2 x 1.0 .3.6
 Weight complete 1200 lbs.; no B. B. 570 lbs.

- D.....\$67.50
- H.....60.50
- L.....58.50
- K.....56.00
- L.....53.50

If B. B. is omitted deduct \$12.25
 Face of panel polished; balance sand finished.

No. 4947¹/₄

Die.....2.6 x 0.8 x 2.6 .4.2
 B. Base.....3.0 x 1.2 x 1.0 .3.6
 Weight complete 1300 lbs.; no B. B. 670 lbs.

- C.....\$81.00
- D.....71.50
- F.....67.50
- G.....65.50
- H.....63.50
- I.....61.00
- K.....58.00
- L.....55.00

If B. B. is omitted deduct \$12.25

No. 4939¹/₂

Die.....2.4 x 0.6 x 2.0 .2.4
 B. Base....2.10 x 1.0 x 0.10 .2.4
 Weight complete 800 lbs.; no B. B. 380 lbs.

- D.....\$50.00
- H.....45.25
- I.....44.00
- K.....42.25
- L.....40.50

If B. B. is omitted deduct \$8.40
 Face of panel polished; balance sand finished.

No. 4947¹/₂

Die.....2.2 x 0.6 x 2.2 .2.4
 B. Base....2.8 x 1.0 x 0.10 .2.3
 Weight complete 800 lbs.; no B. B. 400 lbs.

- C.....\$51.00
- D.....46.00
- F.....43.50
- G.....42.50
- H.....41.25
- I.....40.00
- K.....38.25
- L.....36.50

If B. B. is omitted deduct \$8.10

No. 4950

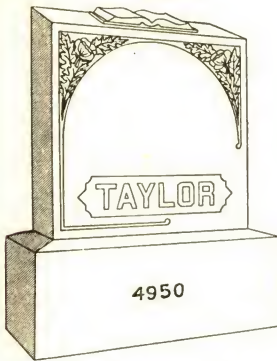

Die.....2.6 x 1.0 x 2.8..6.8
 B. Base.....3.0 x 1.6 x 1.2..5.3
 Weight complete 2100 lbs.; no B. B. 1155 lbs.

C.....	\$131.00
D.....	116.00
F.....	110.00
G.....	106.00
H.....	103.00
I.....	99.50
K.....	94.50
L.....	89.50

If B. B. is omitted deduct \$18.40
 Face of die and book polished, balance sand finished.

No. 4950¹/₄

Die.....2.4 x 0.10 x 2.6..4.10
 B. Base.....2.10 x 1.4 x 1.0..3.9
 Weight complete 1500 lbs.; no B. B. 825 lbs.

C.....	\$97.00
D.....	86.00
F.....	81.00
G.....	78.50
H.....	76.50
I.....	74.00
K.....	70.00
L.....	66.50

If B. B. is omitted deduct \$13.15
 Face of die and book polished, balance sand finished.

No. 4950¹/₂

Die.....2.0 x 0.8 x 2.2..2.11
 B. Base.....2.6 x 1.2 x 1.0..2.11
 Weight complete 1025 lbs.; no B. B. 500 lbs.

C.....	\$68.00
D.....	61.50
F.....	58.50
G.....	57.00
H.....	55.50
I.....	54.00
K.....	52.00
L.....	49.75

If B. B. is omitted deduct \$10.50
 Face of die and book polished; balance sand finished.

No. 4951



Die.....2.6 x 1.0 x 2.6..6.3
 B. Base.....3.0 x 1.6 x 1.2..5.3
 Weight complete 2000 lbs.; no B. B. 1055 lbs.

C.....	\$121.00
D.....	107.00
F.....	101.00
G.....	98.00
H.....	95.50
I.....	91.50
K.....	87.00
L.....	82.00

If B. B. is omitted deduct \$18.40
 Face polished; balance sand finished

No. 4951¹/₄

Die.....2.4 x 0.10 x 2.4..4.6
 B. Base.....2.10 x 1.4 x 1.0..3.9
 Weight complete 1425 lbs.; no B. B. 750 lbs.

C.....	\$88.00
D.....	78.00
F.....	73.50
G.....	71.00
H.....	69.00
I.....	66.50
K.....	63.00
L.....	60.00

If B. B. is omitted deduct \$13.15
 Face polished; balance sand finished

No. 4951¹/₂

Die.....2.0 x 0.8 x 2.0..2.8
 B. Base.....2.6 x 1.2 x 1.0..2.11
 Weight complete 1000 lbs.; no B. B. 475 lbs.

C.....	\$60.50
D.....	54.50
F.....	51.50
G.....	50.50
H.....	49.00
I.....	47.75
K.....	45.75
L.....	43.75

If B. B. is omitted deduct \$10.50
 Face polished; balance sand finished

No. 4952



Die.....2.6 $\frac{1}{2}$ x 1.0 x 2.6 . . 6.3
 B. Base.....3.0 $\frac{1}{2}$ x 1.6 x 1.2 . . 5.3
 Weight complete 2000 lbs.; no B. B. 1055 lbs.
 C.....\$121.00
 D.....107.00
 F.....101.00
 G.....98.00
 H.....95.50
 I.....91.50
 K.....87.00
 L.....82.00
 If B. B. is omitted deduct \$18.40
 Face polished; balance sand finished

No. 4952 $\frac{1}{4}$

Die.....2.4 x 0.10 x 2.4 . . 4.6
 B. Base.....2.10 x 1.4 x 1.0 . . 3.9
 Weight complete 1425 lbs.; no B. B. 750 lbs.
 C.....\$88.00
 D.....78.00
 F.....73.50
 G.....71.00
 H.....69.00
 I.....66.50
 K.....63.00
 L.....60.00
 If B. B. is omitted deduct \$13.15
 Face polished; balance sand finished

No. 4952 $\frac{1}{2}$

Die.....2.0 x 0.8 x 2.0 . . 2.8
 B. Base.....2.6 x 1.2 x 1.0 . . 2.11
 Weight complete 1000 lbs.; no B. B. 475 lbs.
 C.....\$60.50
 D.....54.50
 F.....51.50
 G.....50.50
 H.....49.00
 I.....47.75
 K.....45.75
 L.....43.75
 If B. B. is omitted deduct \$10.50
 Face polished; balance sand finished.

No. 4955



Die.....2.6 x 0.10 x 2.6 . . 5.3
 B. Base.....3.0 x 1.4 x 1.2 . . 4.8
 Weight complete 1725 lbs.; no B. B. 885 lbs.
 C.....\$101.00
 D.....89.50
 F.....84.50
 G.....82.00
 H.....79.00
 I.....76.50
 K.....72.50
 L.....68.50
 If B. B. is omitted deduct \$16.35
 Face only polished; if all polished, extra \$3.25.

Tracing raised $\frac{1}{4}$ inch

No. 4955 $\frac{1}{4}$

Die.....2.4 x 0.8 x 2.4 . . 3.8
 B. Base.....2.10 x 1.2 x 1.0 . . 3.4
 Weight complete 1225 lbs.; no B. B. 625 lbs.
 C.....\$75.00
 D.....67.00
 F.....63.00
 G.....61.50
 H.....59.50
 I.....57.50
 K.....55.00
 L.....52.00
 If B. B. is omitted deduct \$11.65
 Face only polished; if all polished, extra \$3.00.

Tracing raised $\frac{1}{4}$ inch

No. 4955 $\frac{1}{2}$

Die.....2.0 x 0.6 x 2.0 . . 2.0
 B. Base.....2.6 x 1.0 x 0.10 . . 2.1
 Weight complete 725 lbs.; no B. B. 350 lbs.
 C.....\$46.75
 D.....42.25
 F.....40.25
 G.....39.25
 H.....38.25
 I.....37.25
 K.....35.75
 L.....34.25
 If B. B. is omitted deduct \$7.50
 Face only polished; if all polished, extra \$2.50.

Tracing raised $\frac{1}{4}$ inch

No. 4957

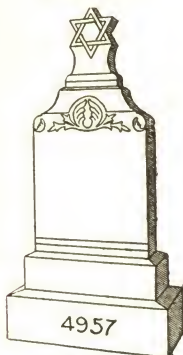

Finial.....1.2 x 0.5 x 1.8 .0.10
 Die.....2.4 x 0.10 x 3.2 .6.2
 Base.....2.8 x 1.2 x 0.8 .2.1
 B. Base....3.2 x 1.8 x 1.0 .5.3
 Weight complete 2450 lbs.; no B. B. 1500 lbs.
 C.....\$171.00
 D.....151.00
 F.....141.00
 G.....137.00
 H.....132.00
 I.....128.00
 K.....121.00
 L.....114.00
 If B. B. is omitted deduct \$18.40

No. 4957¹/₄

Finial.....1.0 x 0.4 x 1.6 .0.6
 Die.....2.2 x 0.8 x 3.0 .4.4
 Base.....2.6 x 1.0 x 0.8 .1.8
 B. Base....3.0 x 1.6 x 1.0 .4.6
 Weight complete 1875 lbs.; no B. B. 1065 lbs.
 C.....\$132.00
 D.....117.00
 F.....111.00
 G.....108.00
 H.....104.00
 I.....101.00
 K.....96.00
 L.....92.00
 If B. B. is omitted deduct \$15.75

No. 4957¹/₂

Finial.....0.10 x 0.4 x 1.4 .0.4
 Die.....1.10 x 0.6 x 2.6 .2.4
 Base.....2.2 x 0.10 x 0.6 .0.11
 B. Base....2.8 x 1.4 x 1.0 .3.7
 Weight complete 1200 lbs.; no B. B. 555 lbs.
 C.....\$83.00
 D.....75.00
 F.....71.00
 G.....69.50
 H.....67.50
 I.....66.00
 K.....63.00
 L.....60.50
 If B. B. is omitted deduct \$12.55

No. 4958

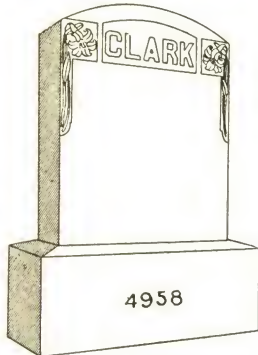

Die.....2.4 x 0.10 x 2.8 .5.2
 B. Base....2.10 x 1.4 x 1.2 .4.5
 Weight complete 1675 lbs.; no B. B. 880 lbs.
 C.....\$95.00
 D.....83.50
 F.....78.50
 G.....76.00
 H.....73.50
 I.....70.50
 K.....67.00
 L.....63.00
 If B. B. is omitted deduct \$15.45

No. 4958¹/₄

Die.....2.0 x 0.8 x 2.6 .3.4
 B. Base....2.6 x 1.2 x 1.0 .2.11
 Weight complete 1075 lbs.; no B. B. 550 lbs.
 C.....\$63.00
 D.....55.50
 F.....52.50
 G.....50.50
 H.....49.00
 I.....47.25
 K.....44.75
 L.....42.25
 If B. B. is omitted deduct \$10.50

No. 4958¹/₂

Die.....1.8 x 0.6 x 2.4 .1.11
 B. Base....2.2 x 1.0 x 0.10 .1.10
 Weight complete 650 lbs.; no B. B. 320 lbs.
 C.....\$39.25
 D.....35.00
 F.....33.00
 G.....32.00
 H.....31.00
 I.....30.00
 K.....28.75
 L.....27.25
 If B. B. is omitted deduct \$6.60

No. 4959

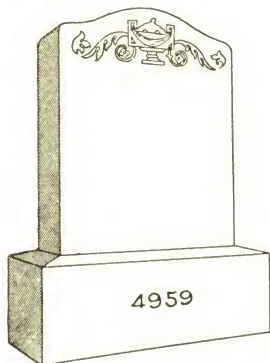

4959

Die.....2. 4 x 0.10 x 2.8. .5.2
 B. Base.....2.10 x 1. 4 x 1.2. .4.5
 Weight complete 1650 lbs.; no B. B. 855 lbs.

- C.....\$95.00
- D.....83.50
- F.....78.50
- G.....76.00
- H.....73.50
- I.....70.50
- K.....67.00
- L.....63.00

If B. B. is omitted deduct \$15.45

No. 4960

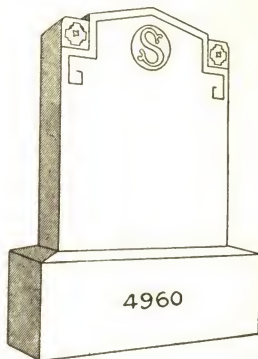

4960

Die.....2. 4 x 0.10 x 2.8. .5.2
 B. Base.....2.10 x 1. 4 x 1.2. .4.5
 Weight complete 1650 lbs.; no B. B. 855 lbs.

- C.....\$95.00
- D.....83.50
- F.....78.50
- G.....76.00
- H.....73.50
- I.....70.50
- K.....67.00
- L.....63.00

If B. B. is omitted deduct \$15.45
 Top of die sand finished

No. 4959¹/₄

Die.....2.0 x 0.8 x 2.6. .3. 4
 B. Base.....2.6 x 1.2 x 1.0. .2.11
 Weight complete 1050 lbs.; no B. B. 525 lbs.

- C.....\$63.00
- D.....55.50
- F.....52.50
- G.....50.50
- H.....49.00
- I.....47.25
- K.....44.75
- L.....42.25

If B. B. is omitted deduct \$10.50

No. 4960¹/₄

Die.....2.0 x 0.8 x 2.6. .3. 4
 B. Base.....2.6 x 1.2 x 1.0. .2.11
 Weight complete 1050 lbs.; no B. B. 525 lbs.

- C.....\$63.00
- D.....55.00
- F.....52.50
- G.....50.50
- H.....49.00
- I.....47.25
- K.....44.75
- L.....42.25

If B. B. is omitted deduct \$10.50
 Top of die sand finished

No. 4959¹/₂

Die.....1.8 x 0.6 x 2. 4. .1.11
 B. Base.....2.2 x 1.0 x 0.10. .1.10
 Weight complete 650 lbs.; no B. B. 320 lbs.

- C.....\$39.25
- D.....35.00
- F.....33.00
- G.....32.00
- H.....31.00
- I.....30.00
- K.....28.75
- L.....27.25

If B. B. is omitted deduct \$6.60

No. 4960¹/₂

Die.....1.8 x 0.6 x 2. 4. .1.11
 B. Base.....2.2 x 1.0 x 0.10. .1.10
 Weight complete 650 lbs.; no B. B. 320 lbs.

- C.....\$39.25
- D.....35.00
- F.....33.00
- G.....32.00
- H.....31.00
- I.....30.00
- K.....28.75
- L.....27.25

If B. B. is omitted deduct \$6.60
 Top of die sand finished.

No. 4967

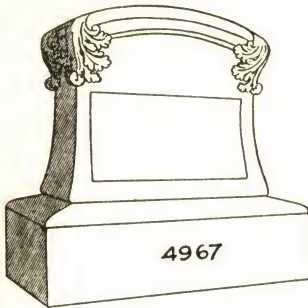

Die..... 3.0 x 1.4 x 2.6 . 10.0
 B. Base..... 3.9 x 2.1 x 1.2 . 9.1
 Weight complete 3000 lbs.; no B. B. 1365 lbs.

- C.....\$289.00
- D..... 266.00
- F..... 256.00
- G..... 251.00
- H..... 246.00
- I..... 241.00
- K..... 234.00
- L..... 226.00

If B. B. is omitted deduct \$31.80
 All sand finished

No. 4967¹/₄

Die..... 2.8 x 1.2 x 2.4 . 7.3
 B. Base..... 3.4 x 1.10 x 1.2 . 7.2
 Weight complete 2200 lbs.; no B. B. 910 lbs.

- C.....\$235.00
- D..... 219.00
- F..... 211.00
- G..... 208.00
- H..... 204.00
- I..... 201.00
- K..... 195.00
- L..... 190.00

If B. B. is omitted deduct \$25.10
 All sand finished

No. 4967¹/₂

Die..... 2.6 x 1.0 x 2.2 . 5.5
 B. Base..... 3.0 x 1.6 x 1.2 . 5.3
 Weight complete 1700 lbs.; no B. B. 755 lbs.

- C.....\$193.00
- D..... 181.00
- F..... 175.00
- G..... 173.00
- H..... 170.00
- I..... 167.00
- K..... 163.00
- L..... 159.00

If B. B. is omitted deduct \$18.40
 All sand finished

No. 4969

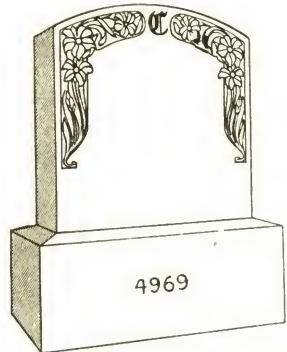

Die..... 2.6 x 0.10 x 2.6 . 5.3
 B. Base..... 3.0 x 1.4 x 1.2 . 4.8
 Weight complete 1725 lbs.; no B. B. 885 lbs.

- C.....\$101.00
- D..... 89.50
- F..... 84.50
- G..... 83.00
- H..... 79.00
- I..... 76.50
- K..... 72.50
- L..... 68.50

If B. B. is omitted deduct \$16.35
 Face only polished; if all polished extra
 \$3.75. Tracing raised ¹/₄ inch.

No. 4969¹/₄

Die..... 2.4 x 0.8 x 2.4 . 3.8
 B. Base..... 2.10 x 1.2 x 1.0 . 3.4
 Weight complete 1225 lbs.; no B. B. 625 lbs.

- C.....\$75.00
- D..... 67.00
- F..... 63.00
- G..... 61.50
- H..... 59.50
- I..... 57.50
- K..... 55.00
- L..... 52.00

If B. B. is omitted deduct \$11.65
 Face only polished; if all polished extra
 \$3.50. Tracing raised ¹/₄ inch.

No. 4969¹/₂

Die..... 2.0 x 0.6 x 2.0 . 2.0
 B. Base..... 2.6 x 1.0 x 0.10 . 2.1
 Weight complete 725 lbs.; no B. B. 350 lbs.

- C.....\$46.75
- D..... 42.25
- F..... 40.25
- G..... 39.25
- H..... 38.25
- I..... 37.25
- K..... 35.75
- L..... 34.25

If B. B. is omitted deduct \$7.50
 Face only polished; if all polished extra
 \$3.00. Tracing raised ¹/₄ inch.

No. 4970

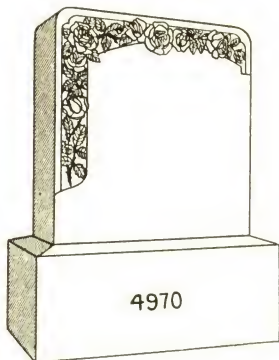

Die.....2.6 x 0.10 x 2.6 .5.3
 B. Base.....3.0 x 1.4 x 1.2 .4.8
 Weight complete 1750 lbs.; no B. B. 910 lbs.

C.....	\$101.00
D.....	89.50
F.....	84.50
G.....	83.00
H.....	79.00
I.....	76.50
K.....	72.50
L.....	68.50

If B. B. is omitted deduct \$16.35
 Face only polished; if all polished extra \$3.75. Tracing raised $\frac{1}{8}$ inch.

No. 4970 $\frac{1}{4}$

Die.....2.4 x 0.8 x 2.4 .3.8
 B. Base.....2.10 x 1.2 x 1.0 .3.4
 Weight complete 1250 lbs.; no B. B. 650 lbs.

C.....	\$75.00
D.....	67.00
F.....	63.00
G.....	61.50
H.....	59.50
I.....	57.50
K.....	55.00
L.....	52.00

If B. B. is omitted deduct \$11.65
 Face only polished. If all polished extra \$3.50. Tracing raised $\frac{1}{8}$ inch.

No. 4970 $\frac{1}{2}$

Die.....2.0 x 0.6 x 2.0 .2.0
 B. Base.....2.6 x 1.0 x 0.10 .2.1
 Weight complete 750 lbs.; no B. B. 375 lbs.

C.....	\$46.75
D.....	42.25
F.....	40.25
G.....	39.25
H.....	38.25
I.....	37.25
K.....	35.75
L.....	34.25

If B. B. is omitted deduct \$7.50
 Face only polished; if all polished extra \$3.00. Tracing raised $\frac{1}{8}$ inch.

No. 4971

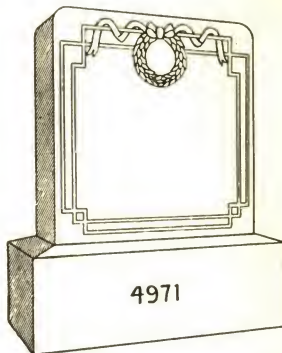

Die.....2.6 x 0.10 x 2.6 .5.3
 B. Base.....3.0 x 1.4 x 1.2 .4.8
 Weight complete 1750 lbs.; no B. B. 910 lbs.

D.....	\$83.50
H.....	73.00
I.....	70.50
K.....	66.50
L.....	62.50

If B. B. is omitted deduct \$16.35
 Face only polished; if all polished extra \$3.75.

No. 4971 $\frac{1}{4}$

Die.....2.4 x 0.8 x 2.4 .3.8
 B. Base.....2.10 x 1.2 x 1.0 .3.4
 Weight complete 1250 lbs.; no B. B. 650 lbs.

D.....	\$61.00
H.....	53.50
I.....	51.50
K.....	49.00
L.....	46.25

If B. B. is omitted deduct \$11.65
 Face only polished; if all polished extra \$3.50.

No. 4971 $\frac{1}{2}$

Die.....2.0 x 0.6 x 2.0 .2.0
 B. Base.....2.6 x 1.0 x 0.10 .2.1
 Weight complete 750 lbs.; no B. B. 375 lbs.

D.....	\$36.25
H.....	32.25
I.....	31.25
K.....	29.75
L.....	28.25

If B. B. is omitted deduct \$7.50
 Face only polished; if all polished extra \$3.00.

No. 4975 $\frac{1}{2}$

Die.....2.6 x 1.0 x 2.2 .5.5
 Base.....3.0 x 1.6 x 0.8 .3.0
 B. Base.....3.8 x 2.2 x 1.2 .9.3
 Weight complete 2850 lbs.; no B. B. 1185 lbs.

D.....	\$236.00
H.....	219.00
I.....	215.00
K.....	209.00
L.....	203.00

If B. B. is omitted deduct \$32.40
 All sand finished

No. 4975 $\frac{1}{4}$

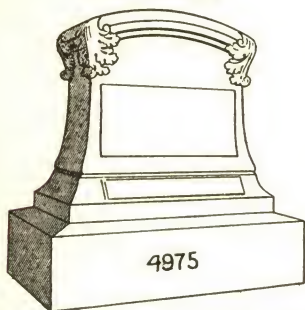

Die.....2. 8 x 1.2 x 2.4.. 7.3
 Base.....3. 2 x 1.8 x 0.8.. 3.6
 B. Base....3.10 x 2.4 x 1.2.. 10.5
 Weight complete 3500 lbs.; no B. B. 1625 lbs.

C.....	\$301.00
D.....	276.00
F.....	266.00
G.....	260.00
H.....	255.00
I.....	250.00
K.....	241.00
L.....	233.00

If B. B. is omitted deduct \$36.45
 All sand finished

No. 4975 $\frac{1}{2}$

See previous page.

No. 4976

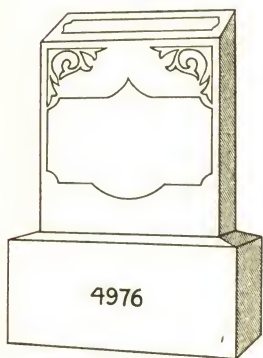

Formerly Design "X"

Die.....2.0 x 1.0 x 2.6.. 5.0
 B. Base.....2.6 x 1.6 x 1.2.. 4.5
 Weight complete 1600 lbs.; no B. B. 800 lbs.

D.....	\$77.00
H.....	67.00
I.....	64.50
K.....	60.50
L.....	56.50

If bottom base is omitted deduct \$15.45;
 top and face polished; balance sand finished.

No. 4977

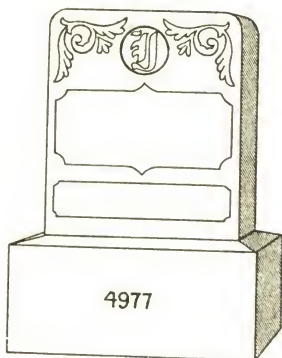

Formerly Design "Y"

Die.....2.0 x 0.10 x 2.4.. 3.11
 B. Base....2.6 x 1.4 x 1.0.. 3.4
 Weight complete 1275 lbs.; no B. B. 670 lbs.

D.....	\$59.50
H.....	51.50
I.....	49.50
K.....	46.50
L.....	43.75

If B. B. is omitted deduct \$11.65; back
 and face polished; balance sand finished.

No. 4978

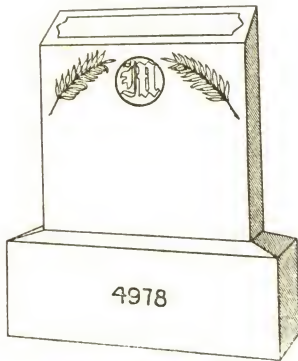

Formerly Design "Z"

Die.....1.10 x 0.8 x 2.0.. 2.5
 B. Base....2.4 x 1.2 x 1.0.. 2.9
 Weight complete 900 lbs.; no B. B. 400 lbs.

D.....	\$41.75
H.....	37.00
I.....	35.75
K.....	34.00
L.....	32.25

If bottom base is omitted deduct \$9.90;
 top and face polished; balance sand finished.

No. 4981

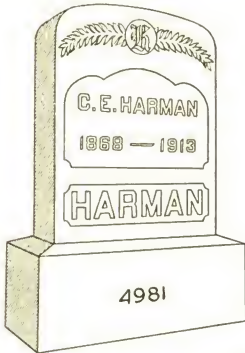

Die.....2. 4 x 0.10 x 2.8. .5.2
 B. Base....2.10 x 1. 4 x 1.0. .3.9
 Weight complete 1575 lbs.; no B. B. 880 lbs.

C.....	\$93.00
D.....	81.50
F.....	76.50
G.....	74.00
H.....	71.50
I.....	68.50
K.....	65.00
L.....	61.00

If B. B. is omitted deduct \$13.15
 Face only polished; balance sand finished

No. 4981¹/₄

Die.....2.0 x 0.8 x 2.6. .3. 4
 B. Base....2.6 x 1.2 x 1.0. .2.11
 Weight complete 1100 lbs.; no B. B. 575 lbs.

C.....	\$66.50
D.....	59.00
F.....	56.00
G.....	54.00
H.....	52.50
I.....	51.00
K.....	48.25
L.....	45.75

If B. B. is omitted deduct \$10.50
 Face only polished; balance sand finished

No. 4981¹/₂

Die.....1.8 x 0.6 x 2. 4. .1.11
 B. Base....2.2 x 1.0 x 0.10. .1.10
 Weight complete 675 lbs.; no B. B. 345 lbs

C.....	\$39.25
D.....	35.00
F.....	33.00
G.....	32.00
H.....	31.00
I.....	30.25
K.....	28.75
L.....	27.25

If B. B. is omitted deduct \$6.60
 Face only polished; balance sand finished

No. 4982

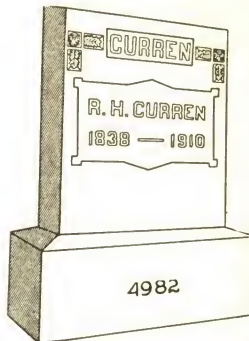

Die.....2. 4 x 0.10 x 2.8. .5.2
 B. Base....2.10 x 1. 4 x 1.0. .3.9
 Weight complete 1575 lbs.; no B. B. 900 lbs.

C.....	\$95.00
D.....	83.50
F.....	78.50
G.....	76.00
H.....	73.50
I.....	70.50
K.....	67.00
L.....	63.00

If B. B. is omitted deduct \$13.15
 Face and top polished; balance sand finished.

No. 4982¹/₄

Die.....2.0 x 0.8 x 2.6. .3. 4
 B. Base....2.6 x 1.2 x 1.0. .2.11
 Weight complete 1100 lbs.; no B. B. 575 lbs.

C.....	\$67.50
D.....	60.00
F.....	57.00
G.....	55.00
H.....	53.50
I.....	52.00
K.....	49.25
L.....	46.75

If B. B. is omitted deduct \$10.50
 Face and top polished; balance sand finished.

No. 4982¹/₂

Die.....1.8 x 0.6 x 2. 4. .1.11
 B. Base....2.2 x 1.0 x 0.10. .1.10
 Weight complete 675 lbs.; no B. B. 345 lbs.

C.....	\$45.25
D.....	41.00
F.....	39.00
G.....	38.00
H.....	37.00
I.....	36.25
K.....	34.75
L.....	33.25

If B. B. is omitted deduct \$6.60
 Face and top polished; balance sand finished.

No. 4983



Die.....2. 4 x 0.10 x 2.8. .5.2
 B. Base....2.10 x 1. 4 x 1.0. .3.9
 Weight complete 1575 lbs.; no B. B. 855 lbs.

- C.....\$94.00
- D.....82.50
- F.....77.50
- G.....75.00
- H.....72.50
- I.....69.50
- K.....66.00
- L.....62.00

If B. B. is omitted deduct \$13.15
 Face only polished; balance sand finished

No. 4983¹/₄

Die.....2.0 x 0.8 x 2.6. .3. 4
 B. Base....2.6 x 1.2 x 1.0. .2.11
 Weight complete 1050 lbs.; no B. B. 525 lbs.

- C.....\$66.50
- D.....59.00
- F.....56.00
- G.....54.00
- H.....52.50
- I.....51.00
- K.....48.25
- L.....45.75

If B. B. is omitted deduct \$10.50
 Face only polished; balance sand finished

No. 4983¹/₂

Die.....1.8 x 0.6 x 2. 4. .1.11
 B. Base....2.2 x 1.0 x 0.10. .1.10
 Weight complete 650 lbs.; no B. B. 320 lbs.

- C.....\$41.75
- D.....37.50
- F.....35.50
- G.....34.50
- H.....33.50
- I.....32.75
- K.....31.25
- L.....29.75

If B. B. is omitted deduct \$6.60
 Face only polished; balance sand finished

No. 4986

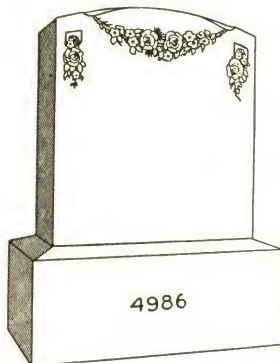

Die.....2. 4 x 0.10 x 2.6. .4.10
 B. Base....2.10 x 1. 4 x 1.0. .3. 9
 Weight complete 1500 lbs.; no B. B. 825 lbs.

- C.....\$94.00
- D.....83.00
- F.....78.00
- G.....75.50
- H.....73.50
- I.....71.00
- K.....67.00
- L.....63.50

If B. B. is omitted deduct \$13.15

No. 4986¹/₄

Die.....2.0 x 0.8 x 2.2. .2.11
 B. Base....2.6 x 1.2 x 1.0. .2.11
 Weight complete 1000 lbs.; no B. B. 475 lbs.

- C.....\$64.50
- D.....58.00
- F.....55.00
- G.....53.50
- H.....52.00
- I.....50.50
- K.....48.50
- L.....46.25

If B. B. is omitted deduct \$10.50

No. 4986¹/₂

Die.....1.10 x 0.6 x 2. 0. .1.10
 B. Base....2. 4 x 1.0 x 0.10. .1.11
 Weight complete 650 lbs.; no B. B. 300 lbs.

- C.....\$44.00
- D.....40.00
- F.....38.00
- G.....37.25
- H.....36.25
- I.....35.25
- K.....34.00
- L.....32.50

If B. B. is omitted deduct \$6.90

No. 4989

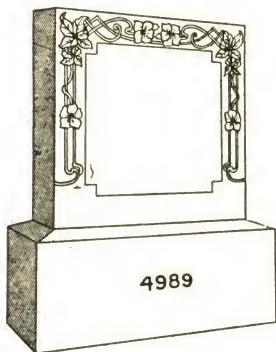

Die.....2. 4 x 0.10 x 2.4. .4.6
 B. Base.....2.10 x 1. 4 x 1.0. .3.9
 Weight complete 1475 lbs.; no B. B. 800 lbs.

C.....	\$91.50
D.....	81.50
F.....	77.00
G.....	74.50
H.....	72.50
I.....	70.00
K.....	66.50
L.....	63.50

If B. B. is omitted deduct \$13.15

No. 4991

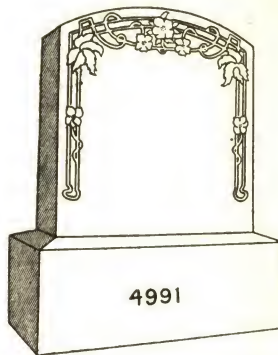

Die.....2. 4 x 0.10 x 2.6. .4.10
 B. Base.....2.10 x 1. 4 x 1.0. .3.9
 Weight complete 1500 lbs.; no B. B. 855 lbs.

C.....	\$94.00
D.....	83.00
F.....	78.00
G.....	75.50
H.....	73.50
I.....	71.00
K.....	67.00
L.....	63.50

If B. B. is omitted deduct \$13.15

No. 4989¹/₄

Die.....2.2 x 0.8 x 2.2. .3.2
 B. Base.....2.8 x 1.2 x 1.0. .3.1
 Weight complete 1125 lbs.; no B. B. 570 lbs.

C.....	\$68.50
D.....	61.50
F.....	58.50
G.....	57.00
H.....	55.50
I.....	53.50
K.....	51.50
L.....	49.00

If B. B. is omitted deduct \$10.80

No. 4991¹/₄

Die.....2.2 x 0.8 x 2.4. .3.4
 B. Base.....2.8 x 1.2 x 1.0. .3.1
 Weight complete 1150 lbs.; no B. B. 600 lbs.

C.....	\$69.00
D.....	61.50
F.....	58.50
G.....	56.50
H.....	55.00
I.....	53.50
K.....	51.00
L.....	48.25

If B. B. is omitted deduct \$10.80

No. 4989¹/₂

Die.....2.0 x 0.6 x 2. 0. .2.0
 B. Base.....2.6 x 1.0 x 0.10. .2.1
 Weight complete 735 lbs.; no B. B. 360 lbs.

C.....	\$47.75
D.....	43.25
F.....	41.25
G.....	40.25
H.....	39.25
I.....	38.25
K.....	36.75
L.....	35.25

If B. B. is omitted deduct \$7.50

No. 4991¹/₂

Die.....2.0 x 0.6 x 2. 2. .2.2
 B. Base.....2.6 x 1.0 x 0.10. .2.1
 Weight complete 760 lbs.; no B. B. 385 lbs.

C.....	\$49.50
D.....	44.50
F.....	42.50
G.....	41.25
H.....	40.25
I.....	39.25
K.....	37.50
L.....	36.00

If B. B. is omitted deduct \$7.50

No. 4999

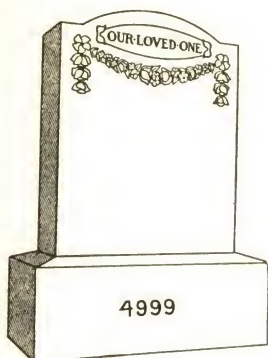

Die.....2. 4 x 0.10 x 2.8..5.2
 B. Base....2.10 x 1. 4 x 1.0..3.9
 Weight complete 1550 lbs.; no B. B. 875 lbs.

C.....	\$97.50
D.....	86.00
F.....	81.00
G.....	78.50
H.....	76.00
I.....	73.00
K.....	69.50
L.....	65.50

If B. B. is omitted deduct \$13.15
 Cut parts sand finished

No. 4999¹/₄

Die.....2.0 x 0.8 x 2.4..3.1
 B. Base....2.6 x 1.2 x 1.0..2.11
 Weight complete 1050 lbs.; no B. B. 525 lbs.

C.....	\$67.50
D.....	60.50
F.....	57.50
G.....	56.00
H.....	54.50
I.....	53.00
K.....	50.50
L.....	48.25

If B. B. is omitted deduct \$10.50
 Cut parts sand finished

No. 4999¹/₂

Die.....1.8 x 0.6 x 2. 2..1.10
 B. Base....2.2 x 1.0 x 0.10..1.10
 Weight complete 650 lbs.; no B. B. 320 lbs.

C.....	\$45.00
D.....	41.00
F.....	39.00
G.....	38.25
H.....	37.25
I.....	36.25
K.....	35.00
L.....	33.50

If B. B. is omitted deduct \$6.60
 Cut parts sand finished

No. 5005

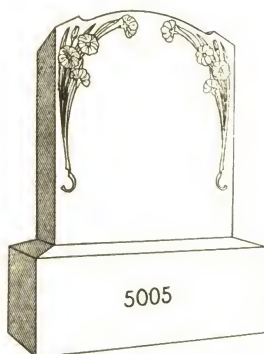

Die.....2. 4 x 0.10 x 2.8..5.2
 B. Base....2.10 x 1. 4 x 1.0..3.9
 Weight complete 1550 lbs.; no B. B. 875 lbs.

C.....	\$97.50
D.....	86.00
F.....	81.00
G.....	78.50
H.....	76.00
I.....	73.00
K.....	69.50
L.....	65.50

If B. B. is omitted deduct \$13.15
 Top sand finished

No. 5005¹/₄

Die.....2.0 x 0.8 x 2.4..3.1
 B. Base....2.6 x 1.2 x 1.0..2.11
 Weight complete 1050 lbs.; no B. B. 525 lbs.

C.....	\$67.50
D.....	60.50
F.....	57.50
G.....	56.00
H.....	54.50
I.....	53.00
K.....	50.50
L.....	48.25

If B. B. is omitted deduct \$10.50
 Top sand finished

No. 5005¹/₂

Die.....1.10 x 0.6 x 2. 2..2. 0
 B. Base....2. 4 x 1.0 x 0.10..1.11
 Weight complete 700 lbs.; no B. B. 355 lbs.

C.....	\$46.75
D.....	42.25
F.....	40.25
G.....	39.25
H.....	38.25
I.....	37.25
K.....	35.75
L.....	34.25

If B. B. is omitted deduct \$6.90
 Top sand finished

No. 5006

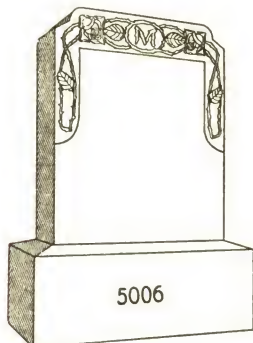

Die.....2. 4 x 0.10 x 2.8. .5.2
 B. Base....2.10 x 1. 4 x 1.0. .3.9
 Weight complete 1550 lbs.; no B. B. 875 lbs.

C.....	\$97.50
D.....	86.00
F.....	81.00
G.....	78.50
H.....	76.00
I.....	73.00
K.....	69.50
L.....	65.50

If B. B. is omitted deduct \$13.15

No. 5008

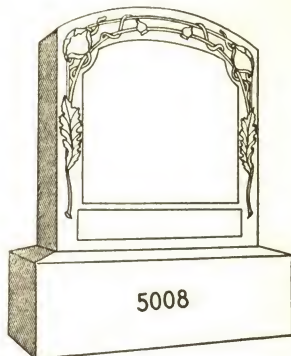

Die.....2. 4 x 0.10 x 2.6. .4.10
 B. Base....2.10 x 1. 4 x 1.0. .3. 9
 Weight complete 1450 lbs.; no B. B. 775 lbs.

C.....	\$97.00
D.....	86.00
F.....	81.00
G.....	78.50
H.....	76.50
I.....	74.00
K.....	70.00
L.....	66.50

If B. B. is omitted deduct \$13.15

No. 5006¹/₄

Die.....2.0 x 0.8 x 2.4. .3. 1
 B. Base....2.6 x 1.2 x 1.0. .2.11
 Weight complete 1050 lbs.; no B. B. 525 lbs.

C.....	\$67.50
D.....	60.50
F.....	57.50
G.....	56.00
H.....	54.50
I.....	53.00
K.....	50.50
L.....	48.25

If B. B. is omitted deduct \$10.50

No. 5008¹/₄

Die.....2.0 x 0.8 x 2.2. .2.11
 B. Base....2.6 x 1.2 x 1.0. .2.11
 Weight complete 1000 lbs.; no B. B. 475 lbs.

C.....	\$67.00
D.....	60.50
F.....	57.50
G.....	56.00
H.....	54.50
I.....	53.00
K.....	51.00
L.....	48.75

If B. B. is omitted deduct \$10.50

No. 5006¹/₂

Die.....1.10 x 0.6 x 2. 2. .2. 0
 B. Base....2. 4 x 1.0 x 0.10. .1.11
 Weight complete 700 lbs.; no B. B. 355 lbs.

C.....	\$46.75
D.....	42.25
F.....	40.25
G.....	39.25
H.....	38.25
I.....	37.25
K.....	35.75
L.....	34.25

If B. B. is omitted deduct \$6.90

No. 5008¹/₂

Die.....1.10 x 0.6 x 2. 0. .1.10
 B. Base....2. 4 x 1.0 x 0.10. .1.11
 Weight complete 650 lbs.; no B. B. 305 lbs.

C.....	\$46.25
D.....	42.25
F.....	40.25
G.....	39.50
H.....	38.50
I.....	37.50
K.....	36.25
L.....	34.75

If B. B. is omitted deduct \$6.90

No. 5009

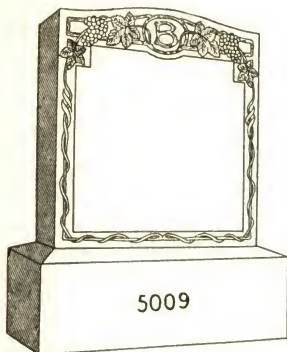

Die.....2. 4 x 0.10 x 2.6. .4. 10
 B. Base...2. 10 x 1. 4 x 1.0. .3. 9
 Weight complete 1450 lbs.; no B. B. 775 lbs.

C.....	\$100.00
D.....	89.50
F.....	84.50
G.....	82.00
H.....	80.00
I.....	77.50
K.....	73.50
L.....	70.00

If B. B. is omitted deduct \$13.15

No. 5009¹/₄

Die.....2.0 x 0.8 x 2.2. .2. 11
 B. Base....2.6 x 1.2 x 1.0. .2. 11
 Weight complete 1000 lbs.; no B. B. 475 lbs.

C.....	\$66.00
D.....	59.50
F.....	56.50
G.....	55.00
H.....	53.50
I.....	52.00
K.....	50.00
L.....	47.75

If B. B. is omitted deduct \$10.50

No. 5009¹/₂

Die.....1.10 x 0.6 x 2. 0. .1. 10
 B. Base....2. 4 x 1.0 x 0.10. .1. 11
 Weight complete 650 lbs.; no B. B. 305 lbs.

C.....	\$47.50
D.....	43.50
F.....	41.50
G.....	40.75
H.....	39.75
I.....	38.75
K.....	37.50
L.....	36.00

If B. B. is omitted deduct \$6.90

No. 5013

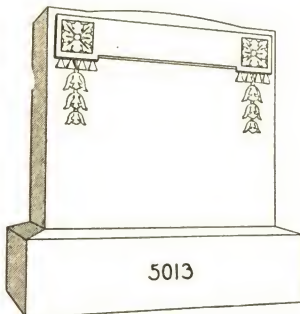

Die.....3. 2 x 1. 2 x 2.10. .10. 6
 B. Base...3.10 x 1.10 x 1. 4. .9. 4
 Weight complete 3200 lbs.; no B. B. 1520 lbs.

C.....	\$223.00
D.....	199.00
F.....	189.00
G.....	184.00
H.....	178.00
I.....	173.00
K.....	165.00
L.....	157.00

If B. B. is omitted deduct \$32.65
 Hone finish

No. 5013¹/₄

Die.....3.0 x 1.0 x 2.8. .8. 0
 B. Base....3.6 x 1.6 x 1.2. .6. 2
 Weight complete 2400 lbs.; no B. B. 1290 lbs.

C.....	\$177.00
D.....	159.00
F.....	151.00
G.....	147.00
H.....	143.00
I.....	139.00
K.....	133.00
L.....	127.00

If B. B. is omitted deduct \$21.60
 Hone finish

No. 5013¹/₂

Die.....2.10 x 0.10 x 2.6. .5. 11
 B. Base....3. 4 x 1. 4 x 1.0. .4. 5
 Weight complete 1700 lbs.; no B. B. 920 lbs.

C.....	\$137.00
D.....	124.00
F.....	118.00
G.....	115.00
H.....	112.00
I.....	109.00
K.....	105.00
L.....	100.00

If B. B. is omitted deduct \$15.45
 Hone finish

No. 5016



Die.....3.8 x 0.10 x 2.8..8.2
 B. Base.....4.2 x 1.4 x 1.0..5.7
 Weight complete 2300 lbs.; no B. B. 1295 lbs.

- C.....\$170.00
- D.....151.00
- F.....143.00
- G.....139.00
- H.....135.00
- I.....131.00
- K.....125.00
- L.....118.00

If B. B. is omitted deduct \$19.55

No. 5016¹/₄

Die.....3.6 x 0.8 x 2.6..5.10
 B. Base.....4.0 x 1.2 x 1.0..4.8
 Weight complete 1750 lbs.; no B. B. 910 lbs.

- C.....\$133.00
- D.....120.00
- F.....114.00
- G.....111.00
- H.....108.00
- I.....105.00
- K.....101.00
- L.....96.50

If B. B. is omitted deduct \$16.35

No. 5016¹/₂

Die.....3.0 x 0.6 x 2.2..3.3
 B. Base.....3.6 x 1.0 x 0.10..2.11
 Weight complete 1050 lbs.; no B. B. 525 lbs.

- C.....\$89.50
- D.....82.00
- F.....79.00
- G.....77.50
- H.....75.50
- I.....74.00
- K.....71.50
- L.....69.00

If B. B. is omitted deduct \$10.50

No. 5020

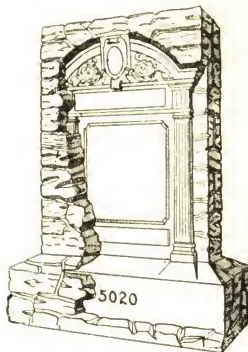

Die.....3.0 x 1.2 x 4.0..14.0
 B. Base.....3.10 x 2.0 x 1.2..8.11

Weight complete 3700 lbs.

Rutland White,
 Riv., S. F., Blue
 or P. V.....\$259.00

No. 5020¹/₄

Die.....3.0 x 1.0 x 4.0..12.0
 B. Base.....3.10 x 1.10 x 1.2..8.2

Weight complete 3300 lbs.

Rutland White,
 Riv., S. F., Blue
 or P. V.....\$237.00

No. 5020¹/₂

Die.....3.0 x 0.10 x 4.0..10.0
 B. Base.....3.8 x 1.6 x 1.2..6.5

Weight complete 2800 lbs.

Rutland White,
 Riv., S. F., Blue
 or P. V.....\$217.00

No. 5026

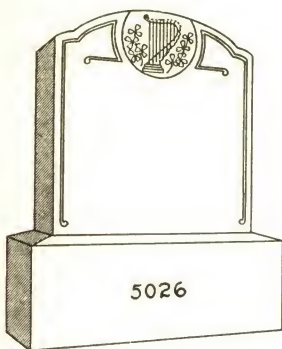

Die.....2. 4 x 0.10 x 2.6. .4.10
 B. Base....2.10 x 1. 4 x 1.0. .3. 9
 Weight complete 1500 lbs.; no B. B. 805 lbs.

C.....	\$93.50
D.....	82.50
F.....	77.50
G.....	75.00
H.....	73.00
I.....	70.50
K.....	66.50
L.....	63.00

If B. B. is omitted deduct \$13.15

No. 5026¹/₄

Die.....2.2 x 0.8 x 2.4. .3.4
 B. Base....2.8 x 1.2 x 1.0. .3.1
 Weight complete 1100 lbs.; no B. B. 545 lbs.

C.....	\$66.50
D.....	59.00
F.....	56.00
G.....	54.00
H.....	52.50
I.....	51.00
K.....	48.25
L.....	45.75

If B. B. is omitted deduct \$10.80

No. 5026¹/₂

Die.....2.0 x 0.6 x 2. 2. .2.2
 B. Base....2.6 x 1.0 x 0.10. .2.1
 Weight complete 725 lbs.; no B. B. 350 lbs.

C.....	\$44.75
D.....	39.75
F.....	37.75
G.....	36.50
H.....	35.50
I.....	34.50
K.....	32.75
L.....	31.25

If B. B. is omitted deduct \$7.50

No. 5027

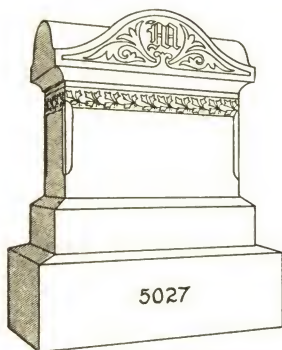

Cap.....3. 4 x 1.10 x 1. 2. . 7. 2
 Die.....2.10 x 1. 4 x 1.10. . 6.11
 Base....3. 4 x 1.10 x 0.10. . 5. 1
 B. Base. 4. 0 x 2. 6 x 1. 2. .11. 8
 Weight complete 5300 lbs.; no B.B.3200 lbs.

C.....	\$333.00
D.....	290.00
F.....	270.00
G.....	261.00
H.....	251.00
I.....	242.00
K.....	227.00
L.....	213.00

If B. B. is omitted deduct \$40.85

No. 5027¹/₄

Cap.....3.1 x 1.7 x 1. 0. .4.11
 Die.....2.8 x 1.2 x 1. 8. .5. 2
 Base....3.0 x 1.6 x 0.10. .3. 9
 B. Base. .3. 8 x 2.2 x 1. 2. .9. 3
 Weight complete 3800 lbs.; no B.B.2135 lbs.

C.....	\$250.00
D.....	219.00
F.....	205.00
G.....	198.00
H.....	191.00
I.....	184.00
K.....	174.00
L.....	164.00

If B. B. is omitted deduct \$32.40

No. 5027¹/₂

Cap.....2.10 x 1. 4 x 1.0. .3.9
 Die.....2. 6 x 1. 0 x 1.6. .3.9
 Base....2.10 x 1. 4 x 0.8. .2.6
 B. Base. .3. 4 x 1.10 x 1.2. .7.2
 Weight complete 2900 lbs.; no B.B.1610 lbs.

C.....	\$190.00
D.....	167.00
F.....	157.00
G.....	152.00
H.....	147.00
I.....	142.00
K.....	135.00
L.....	127.00

If B. B. is omitted deduct \$25.10

No. 5028

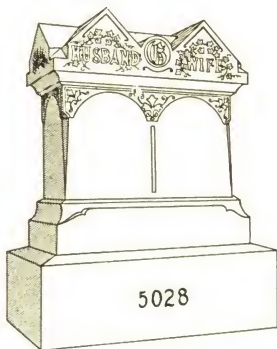

Cap.....3.6 x 1.10 x 1.4.. 8.7
 Die.....3.0 x 1.4 x 2.0.. 8.0
 Base.....3.6 x 1.10 x 0.10.. 5.4
 B. Base...4.2 x 2.6 x 1.2.. 12.2
 Weight complete 5500 lbs.; no B.B. 3310 lbs.

D.....	\$334.00
F.....	312.00
G.....	301.00
H.....	290.00
I.....	279.00
K.....	263.00
L.....	246.00

If B. B. is omitted deduct \$42.60

No. 5028¹/₄

Cap.....3.4 x 1.8 x 1.2.. 6.6
 Die.....2.10 x 1.2 x 1.10.. 6.1
 Base.....3.4 x 1.8 x 0.10.. 4.8
 B. Base...4.0 x 2.4 x 1.2.. 10.11
 Weight complete 4000 lbs.; no B.B. 2035 lbs.

D.....	\$276.00
F.....	258.00
G.....	250.00
H.....	241.00
I.....	233.00
K.....	220.00
L.....	207.00

If B. B. is omitted deduct \$38.20

No. 5028¹/₂

Cap.....2.10 x 1.4 x 1.0.. 3.9
 Die.....2.6 x 1.0 x 1.6.. 3.9
 Base.....2.10 x 1.4 x 0.8.. 2.6
 B. Base...3.4 x 1.10 x 1.2.. 7.2
 Weight complete 2800 lb.; no B.B. 1510 lbs.

D.....	\$172.00
F.....	162.00
G.....	157.00
H.....	152.00
I.....	147.00
K.....	140.00
L.....	132.00

If B. B. is omitted deduct \$25.10

No. 5031

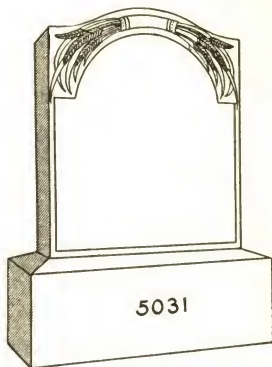

Die.....2.4 x 0.10 x 2.8.. 5.2
 B. Base...2.10 x 1.4 x 1.0.. 3.9
 Weight complete 1575 lbs.; no B. B. 905 lbs.

C.....	\$93.00
D.....	81.50
F.....	76.50
G.....	74.00
H.....	71.50
I.....	68.50
K.....	65.00
L.....	61.00

If B. B. is omitted deduct \$13.15

No. 5031¹/₄

Die.....2.0 x 0.8 x 2.6.. 3.4
 B. Base...2.6 x 1.2 x 1.0.. 2.11
 Weight complete 1100 lbs.; no B. B. 575 lbs.

C.....	\$65.50
D.....	58.00
F.....	55.00
G.....	53.00
H.....	51.50
I.....	50.00
K.....	47.25
L.....	44.75

If B. B. is omitted deduct \$10.50

No. 5031¹/₂

Die.....1.8 x 0.6 x 2.4.. 1.11
 B. Base...2.2 x 1.0 x 0.10.. 1.10
 Weight complete 675 lbs.; no B. B. 345 lbs.

C.....	\$39.25
D.....	35.00
F.....	33.00
G.....	32.00
H.....	31.00
I.....	30.25
K.....	28.75
L.....	27.25

If B. B. is omitted deduct \$6.60

No. 5032

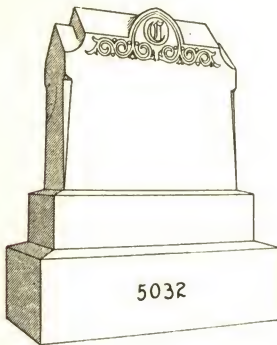

Die.....2.8 x 1. 0 x 2.6..6.8
 Base.....3.0 x 1. 4 x 0.8..2.8
 B. Base.....3.6 x 1.10 x 1.2..7.6
 Weight complete 2900 lbs.; no B.B.1550 lbs.

C.....\$167.00
 D.....146.00
 F.....136.00
 G.....132.00
 H.....127.00
 I.....122.00
 K.....115.00
 L.....108.00

If B. B. is omitted deduct \$26.25

No. 5032¹/₄

Die.....2. 6 x 0.10 x 2.4..4.10
 Base.....2.10 x 1. 2 x 0.8..2. 2
 B. Base...3. 4 x 1. 8 x 1.2..6. 6
 Weight complete 2300 lbs.; no B.B.1130 lbs.

C.....\$131.00
 D.....116.00
 F.....109.00
 G.....105.00
 H.....102.00
 I.....98.00
 K.....93.00
 L.....87.50

If B. B. is omitted deduct \$22.75

No. 5032¹/₂

Die.....2.4 x 0.8 x 2.2..3.4
 Base.....2.8 x 1.0 x 0.8..1.9
 B. Base.....3.2 x 1.6 x 1.0..4.9
 Weight complete 1700 lbs.; no B. B. 845 lbs.

C.....\$101.00
 D.....89.50
 F.....84.50
 G.....82.00
 H.....79.50
 I.....77.00
 K.....73.00
 L.....69.00

If B. B. is omitted deduct \$16.65

No. 5033

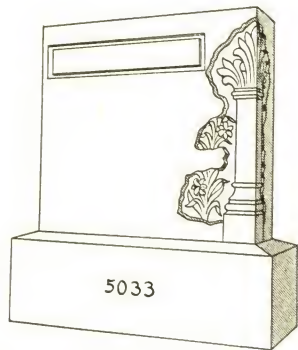

Die.....3.0 x 1.0 x 2.10..8.6
 B. Base.....3.6 x 1.6 x 1. 2..6.2
 Weight complete 2600 lbs.; no B.B.1490 lbs.

Rutland White,
 Riv., S. F., Blue
 or P. V.....\$104.00

If B. B. is omitted deduct \$21.60

No. 5033¹/₄

Die.....2.10 x 0.10 x 2.8..6.4
 B. Base....3. 4 x 1. 4 x 1.2..5.2
 Weight complete 2050 lbs.; no B.B.1120 lbs.

Rutland White,
 Riv., S. F., Blue
 or P. V.....\$86.00

If B. B. is omitted deduct \$18.10

No. 5033¹/₂

Die.....2.8 x 0.8 x 2.6..4.5
 B. Base.....3.2 x 1.2 x 1.0..3.8
 Weight complete 1450 lbs.; no B. B. 790 lbs.

Rutland White,
 Riv., S. F., Blue
 or P. V.....\$68.50

If B. B. is omitted deduct \$12.85

No. 5034

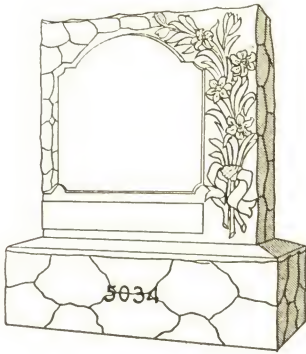

Die.....3.0 x 1.0 x 3.0 .9.0
 B. Base.....3.8 x 1.8 x 1.2 .7.2

Weight complete 2800 lbs.

Rutland White,
 Riv., S. F., Blue
 or P. V.\$148.00

No. 5034¹/₄

Die.....2.10 x 0.10 x 2.10 .6.8
 B. Base....3.6 x 1.6 x 1.2 .6.2

Weight complete 2200 lbs.

Rutland White,
 Riv., S. F., Blue
 or P. V.\$129.00

No. 5034¹/₂

Die.....2.8 x 0.8 x 2.8 .4.9
 B. Base.....3.2 x 1.2 x 1.0 .3.8

Weight complete 1400 lbs.

Rutland White,
 Riv., S. F., Blue
 or P. V.\$108.00

No. 5043

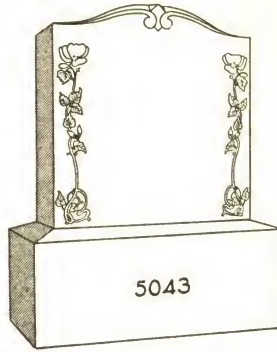

Die.....2.4 x 0.10 x 2.6 .4.10
 B. Base....2.10 x 1.4 x 1.0 .3.9

Weight complete 1500 lbs.; no B. B. 805 lbs.

- C.....\$94.00
- D.....83.00
- F.....78.00
- G.....75.50
- H.....73.50
- I.....71.00
- K.....67.00
- L.....63.50

If B. B. is omitted deduct \$13.15

No. 5043¹/₄

Die.....2.2 x 0.8 x 2.4 .3.4
 B. Base....2.8 x 1.2 x 1.0 .3.1

Weight complete 1100 lbs.; no B. B. 545 lbs.

- C.....\$69.00
- D.....61.50
- F.....58.50
- G.....56.50
- H.....55.00
- I.....53.50
- K.....51.00
- L.....48.25

If B. B. is omitted deduct \$10.80

No. 5043¹/₂

Die.....2.0 x 0.6 x 2.2 .2.2
 B. Base....2.6 x 1.0 x 0.10 .2.1

Weight complete 725 lbs.; no B. B. 350 lbs.

- C.....\$48.50
- D.....43.50
- F.....41.50
- G.....40.25
- H.....39.25
- I.....38.25
- K.....36.50
- L.....35.00

If B. B. is omitted deduct \$7.50

No. 5044

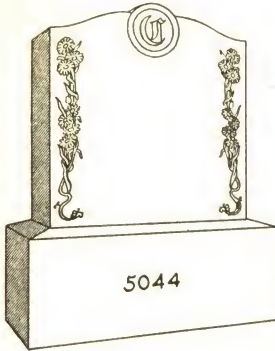

Die.....2. 4 x 0.10 x 2.6. .4.10
 B. Base... 2.10 x 1. 4 x 1.0. .3. 9
 Weight complete 1500 lbs.; no B. B. 805 lbs.

C.....	\$94.00
D.....	83.00
F.....	78.00
G.....	75.50
H.....	73.50
I.....	71.00
K.....	67.00
L.....	63.50

If B. B. is omitted deduct \$13.15

No. 5045



Die.....2.6 x 0.10 x 2.2. .4.6
 B. Base... 3.0 x 1. 4 x 1.0. .4.0
 Weight complete 1500 lbs.; no B. B. 780 lbs.

C.....	\$89.00
D.....	79.00
F.....	74.50
G.....	72.00
H.....	70.00
I.....	67.50
K.....	64.00
L.....	61.00

If B. B. is omitted deduct \$14.00

No. 5044¹/₄

Die.....2.2 x 0.8 x 2.4. .3.4
 B. Base... 2.8 x 1.2 x 1.0. .3.1
 Weight complete 1100 lbs.; no B. B. 545 lbs.

C.....	\$69.00
D.....	61.50
F.....	58.50
G.....	56.50
H.....	55.00
I.....	53.50
K.....	51.00
L.....	48.25

If B. B. is omitted deduct \$10.80

No. 5045¹/₄

Die.....2. 4 x 0.8 x 2.0. .3.1
 B. Base... 2.10 x 1.2 x 1.0. .3.4
 Weight complete 1125 lbs.; no B. B. 525 lbs.

C.....	\$67.50
D.....	60.50
F.....	57.50
G.....	56.00
H.....	54.50
I.....	53.00
K.....	50.50
L.....	48.25

If B. B. is omitted deduct \$11.65

No. 5044¹/₂

Die.....2.0 x 0.6 x 2. 2. .2.2
 B. Base... 2.6 x 1.0 x 0.10. .2.1
 Weight complete 725 lbs.; no B. B. 350 lbs.

C.....	\$48.50
D.....	43.50
F.....	41.50
G.....	40.25
H.....	39.25
I.....	38.25
K.....	36.50
L.....	35.00

If B. B. is omitted deduct \$7.50

No. 5045¹/₂

Die.....2.2 x 0.6 x 1.10. .2.0
 B. Base... 2.8 x 1.0 x 0.10. .2.3
 Weight complete 750 lbs.; no B. B. 345 lbs.

C.....	\$46.75
D.....	42.25
F.....	40.25
G.....	39.25
H.....	38.25
I.....	37.25
K.....	35.75
L.....	34.25

If B. B. is omitted deduct \$8.10

No. 5047

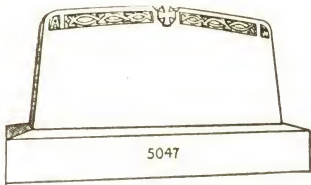

Die.....5. 0 x 1.0 x 2. 4..11.8
 B. Base...5.10 x 1.8 x 0.10.. 8.1
 Weight complete 3000 lbs.; no B.B.1545 lbs.

- C.....\$255.00
- D.....229.00
- F.....217.00
- G.....211.00
- H.....206.00
- I.....200.00
- K.....191.00
- L.....182.00

If B. B. is omitted deduct \$28.30

No. 5047¹/₄

Die.....4.6 x 0.10 x 2. 2..8.2
 B. Base...5.4 x 1. 6 x 0.10..6.8
 Weight complete 2300 lbs.; no B.B.1100 lbs.

- C.....\$198.00
- D.....180.00
- F.....172.00
- G.....168.00
- H.....164.00
- I.....160.00
- K.....154.00
- L.....147.00

If B. B. is omitted deduct \$23.35

No. 5047¹/₂

Die.....4.0 x 0.8 x 2. 0..5.4
 B. Base...4.8 x 1.2 x 0.10..4.6
 Weight complete 1500 lbs.; no B. B. 690 lbs.

- C.....\$152.00
- D.....140.00
- F.....134.00
- G.....132.00
- H.....129.00
- I.....126.00
- K.....122.00
- L.....118.00

If B. B. is omitted deduct \$15.75

No. 5056

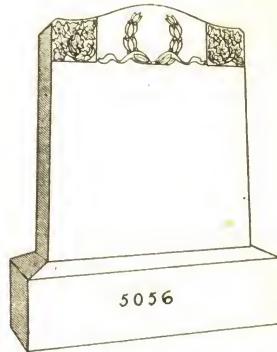

Die.....2.8 x 0.10 x 3.0..6.8
 B. Base.....3.2 x 1. 4 x 1.0..4.3
 Weight complete 1900 lbs.; no B.B.1135 lbs.

- C.....\$125.00
- D.....110.00
- F.....104.00
- G.....100.00
- H.....97.00
- I.....93.50
- K.....88.50
- L.....83.50

If B. B. is omitted deduct \$14.90

No. 5056¹/₄

Die.....2.6 x 0.8 x 2.10..4. 9
 B. Base.....3.0 x 1.2 x 0.10..2.11
 Weight complete 1300 lbs.; no B. B. 775 lbs.

- C.....\$94.00
- D.....83.50
- F.....78.50
- G.....76.50
- H.....74.00
- I.....71.50
- K.....68.00
- L.....64.50

If B. B. is omitted deduct \$10.50

No. 5056¹/₂

Die.....2. 4 x 0.6 x 2. 8..3.1
 B. Base.....2.10 x 1.0 x 0.10..2.4
 Weight complete 900 lbs.; no B. B. 480 lbs.

- C.....\$67.50
- D.....60.50
- F.....57.50
- G.....56.00
- H.....54.50
- I.....53.00
- K.....50.50
- L.....48.25

If B. B. is omitted deduct \$8.40

No. 5059

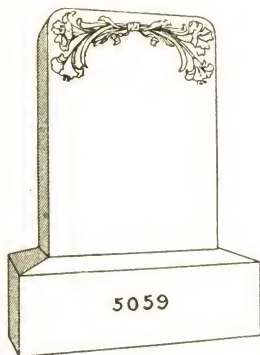

Die.....2.4 x 0.10 x 3.2 .6.2
 B. Base.....3.2 x 1.8 x 1.2 .6.2
 Weight complete 2200 lbs.; no B.B.1090 lbs.

C.....	\$123.00
D.....	109.00
F.....	103.00
G.....	100.00
H.....	97.00
I.....	93.50
K.....	89.00
L.....	84.50

If B. B. is omitted deduct \$21.60

No. 5059¹/₄

Die.....2.2 x 0.8 x 3.0 .4.4
 B. Base.....2.10 x 1.4 x 1.0 .3.9
 Weight complete 1400 lbs.; no B. B. 725 lbs.

C.....	\$87.00
D.....	77.00
F.....	73.00
G.....	70.50
H.....	68.50
I.....	66.50
K.....	63.00
L.....	60.00

If B. B. is omitted deduct \$13.15

No. 5059¹/₂

Die.....2.0 x 0.6 x 2.10 .2.10
 B. Base.....2.6 x 1.0 x 0.10 .2.1
 Weight complete 900 lbs.; no B. B. 525 lbs.

C.....	\$61.00
D.....	54.50
F.....	51.50
G.....	50.00
H.....	48.75
I.....	47.25
K.....	45.25
L.....	43.00

If B. B. is omitted deduct \$7.50

No. 5063

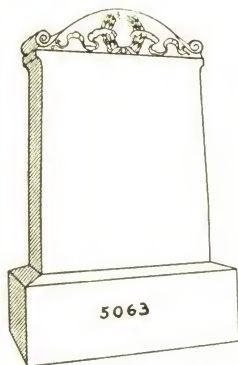

Die.....2.6 x 1.0 x 3.6 .8.9
 B. Base.....3.4 x 1.10 x 1.2 .7.2
 Weight complete 2600 lbs.; no B.B.1310 lbs.

C.....	\$178.00
D.....	158.00
F.....	150.00
G.....	145.00
H.....	141.00
I.....	137.00
K.....	130.00
L.....	123.00

If B. B. is omitted deduct \$25.10

No. 5063¹/₄

Die.....2.4 x 0.10 x 3.4 .6.6
 B. Base.....3.2 x 1.8 x 1.0 .5.3
 Weight complete 1950 lbs.; no B.B.1005 lbs.

C.....	\$139.00
D.....	124.00
F.....	118.00
G.....	115.00
H.....	111.00
I.....	108.00
K.....	103.00
L.....	98.50

If B. B. is omitted deduct \$18.40

No. 5063¹/₂

Die.....2.2 x 0.8 x 3.2 .4.7
 B. Base.....2.10 x 1.4 x 1.0 .3.9
 Weight complete 1400 lbs.; no B. B. 725 lbs.

C.....	\$107.00
D.....	97.00
F.....	92.00
G.....	90.00
H.....	87.50
I.....	85.50
K.....	82.00
L.....	78.50

If B. B. is omitted deduct \$13.15

No. 5064

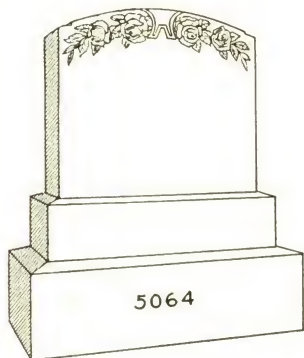

Die.....2.8 x 1.0 x 2.4...6.3
 Base.....3.0 x 1.4 x 0.8...2.8
 B. Base.....3.6 x 1.10 x 1.0...6.5

Weight complete 2500 lbs.; no B.B.1345 lbs.

- C.....\$161.00
- D.....140.00
- F.....132.00
- G.....127.00
- H.....123.00
- I.....118.00
- K.....111.00
- L.....105.00

If B. B. is omitted deduct \$22.45

No. 5064¹/₄

Die.....2.6 x 0.10 x 2.2...4.6
 Base.....2.10 x 1.2 x 0.8...2.2
 B. Base.....3.4 x 1.8 x 1.0...5.7

Weight complete 2050 lbs.; no B.B.1045 lbs.

- C.....\$127.00
- D.....112.00
- F.....106.00
- G.....102.00
- H.....99.00
- I.....95.50
- K.....90.50
- L.....85.50

If B. B. is omitted deduct \$19.55

No. 5064¹/₂

Die.....2.4 x 0.8 x 2.0...3.1
 Base.....2.8 x 1.0 x 0.8...1.9
 B. Base.....3.2 x 1.6 x 0.10...4.0

Weight complete 1500 lbs.; no B. B. 780 lbs.

- C.....\$94.50
- D.....83.50
- F.....78.50
- G.....76.00
- H.....74.00
- I.....71.50
- K.....67.50
- L.....64.00

If B. B. is omitted deduct \$14.00

No. 5067

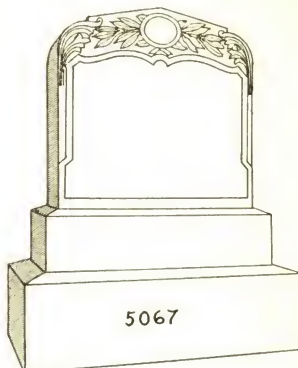

Die.....2.6 x 1.0 x 2.6...6.3
 Base.....2.10 x 1.4 x 0.8...2.6
 B. Base.....3.4 x 1.10 x 1.2...7.2

Weight complete 2800 lbs.; no B.B.1510 lbs.

- C.....\$165.00
- D.....145.00
- F.....136.00
- G.....132.00
- H.....128.00
- I.....124.00
- K.....117.00
- L.....110.00

If B. B. is omitted deduct \$25.10

No. 5067¹/₄

Die.....2.4 x 0.10 x 2.4...4.6
 Base.....2.8 x 1.2 x 0.8...2.1
 B. Base.....3.2 x 1.8 x 1.0...5.3

Weight complete 2000 lbs.; no B.B.1510 lbs.

- C.....\$127.00
- D.....112.00
- F.....106.00
- G.....102.00
- H.....99.00
- I.....96.00
- K.....91.00
- L.....86.00

If B. B. is omitted deduct \$18.40

No. 5067¹/₂

Die.....2.2 x 0.8 x 2.2...3.2
 Base.....2.6 x 1.0 x 0.8...1.8
 B. Base.....3.0 x 1.6 x 1.0...4.6

Weight complete 1600 lbs.; no B. B. 790 lbs.

- C.....\$99.50
- D.....88.50
- F.....83.50
- G.....81.00
- H.....79.00
- I.....76.50
- K.....72.50
- L.....69.00

If B. B. is omitted deduct \$15.75

No. 5069

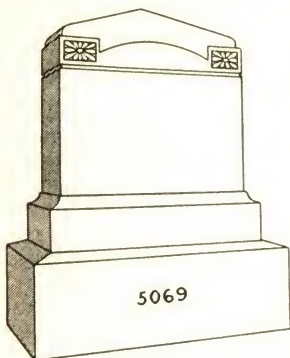

Die.....2. 6 x 1. 0 x 2.6..6.3
 Base.....2.10 x 1. 4 x 0.8..2.6
 B. Base....3. 4 x 1.10 x 1.2..7.2
 Weight complete 2800 lbs.; no B.B.1510 lbs.
 C.....\$175.00
 D.....155.00
 F.....147.00
 G.....142.00
 H.....138.00
 I.....134.00
 K.....127.00
 L.....120.00
 If B. B. is omitted deduct \$25.10
 Back carved same as face

No. 5069¹/₄

Die.....2.4 x 0.10 x 2.4..4.6
 Base.....2.8 x 1. 2 x 0.8..2.1
 B. Base....3.2 x 1. 8 x 1.0..5.3
 Weight complete 2000 lbs.; no B.B.1055 lbs.
 C.....\$142.00
 D.....127.00
 F.....121.00
 G.....117.00
 H.....114.00
 I.....111.00
 K.....106.00
 L.....101.00
 If B. B. is omitted deduct \$18.40
 Back carved same as face

No. 5069¹/₂

Die.....2.2 x 0.8 x 2.2..3.2
 Base.....2.6 x 1.0 x 0.8..1.8
 B. Base....3.0 x 1.6 x 1.0..4.6
 Weight complete 1600 lbs.; no B. B. 790 lbs.
 C.....\$108.00
 D.....97.00
 F.....92.00
 G.....89.50
 H.....87.50
 I.....85.00
 K.....80.00
 L.....77.50
 If B. B. is omitted deduct \$15.75
 Back carved same as face

No. 5071

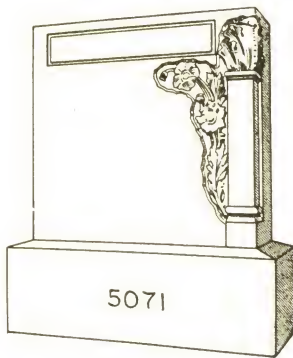

Die.....3.0 x 1.0 x 2.10..8.6
 B. Base....3.6 x 1.6 x 1. 2..6.2
 Weight complete 2600 lbs.; no B.B.1490 lbs.
 Rutland White,
 Riv., S. F., Blue
 or P. V.....\$109.00
 If B. B. is omitted deduct \$21.60
 Face only polished

No. 5071¹/₄

Die.....2.10 x 0.10 x 2.8..6.4
 B. Base....3. 4 x 1. 4 x 1.2..5.2
 Weight complete 2050 lbs.; no B.B.1120 lbs.
 Rutland White,
 Riv., S. F., Blue
 or P. V.....\$90.00
 If B. B. is omitted deduct \$18.10
 Face only polished

No. 5071¹/₂

Die.....2.8 x 0.8 x 2.6..4.5
 B. Base....3.2 x 1.2 x 1.0..3.8
 Weight complete 1450 lbs.; no B. B. 790 lbs.
 Rutland White,
 Riv., S. F., Blue
 or P. V.....\$70.50
 If B. B. is omitted deduct \$12.85
 Face only polished

No. 5072

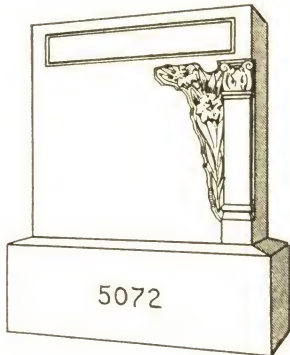

Die.....3.0 x 1.0 x 2.10 .8.6
 B. Base.....3.6 x 1.6 x 1.2 .6.2
 Weight complete 2600 lbs.; no B.B.1490 lbs.

Rutland White,
 Riv., S. F., Blue
 or P. V.....\$103.00
 If B. B. is omitted deduct \$21.60
 Face only polished

No. 5072¹/₄

Die.....2.10 x 0.10 x 2.8 .6.4
 B. Base.....3.4 x 1.4 x 1.2 .5.2
 Weight complete 2050 lbs.; no B.B.1120 lbs.

Rutland White,
 Riv., S. F., Blue
 or P. V.....\$89.00
 If B. B. is omitted deduct \$22.15
 Face only polished

No. 5072¹/₂

Die.....2.8 x 0.8 x 2.6 .4.5
 B. Base.....3.2 x 1.2 x 1.0 .3.8
 Weight complete 1450 lbs.; no B. B. 790 lbs.

Rutland White,
 Riv., S. F., Blue
 or P. V.....\$68.50
 If B. B. is omitted deduct \$15.45
 Face only polished

No. 5077

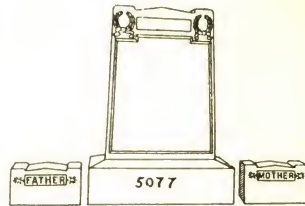

Die.....3.0 x 0.10 x 4.0 .10.0
 B. Base...3.10 x 1.7¹/₂ x 1.0 .6.5
 Weight complete 2800 lbs.; no B.B.1645 lbs.
 H.....\$161.00
 I.....156.00
 K.....149.00
 L.....141.00
 If B. B. is omitted deduct \$22.45
 Face polished; balance sand finished.
 Markers extra. See sizes and prices below.

No. 5077¹/₄

Die.....2.6 x 0.8 x 3.6 .5.10
 B. Base...3.2 x 1.3¹/₂ x 1.0 .4.3
 Weight complete 1750 lbs.; no B. B. 985 lbs.
 H.....\$108.00
 I.....105.00
 K.....101.00
 L.....96.50
 If B. B. is omitted deduct \$14.90
 Face polished; balance sand finished.
 Markers extra. See sizes and prices below.

No. 5077¹/₂

Die.....2.0 x 0.6 x 3.0 .3.0
 B. Base...2.6 x 0.11¹/₂ x 0.10 .2.1
 Weight complete 850 lbs.; no B. B. 475 lbs.
 H.....\$72.00
 I.....70.50
 K.....68.50
 L.....66.00
 If B. B. is omitted deduct \$7.50
 Face polished; balance sand finished.
 Markers extra. See sizes and prices below.

Markers

First size.....1.8 x 0.8 x 1.0 .1.1
 Estimated weight, 180 lbs.
 H.....\$14.25
 I.....13.75
 K.....13.00
 L.....12.25
 Face polished; balance sand finished

Second size...1.8 x 0.6 x 1.0 .0.10
 Estimated weight, 150 lbs.
 H.....\$11.75
 I.....11.25
 K.....10.75
 L.....10.00
 Face polished; balance sand finished

No. 5079

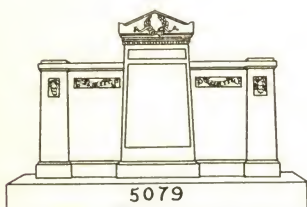

Cap. 2.1½ x 1.0 x 0.11½ . . . 2. 2
 Die. 7.0 x 1.1 x 3.10 . . . 29. 1
 B. Base. 8.7 x 2.1 x 0.10 . . 14. 11

Weight complete 6500 lbs.

C.	\$796.00
D.	726.00
F.	694.00
G.	679.00
H.	663.00
I.	648.00
K.	624.00
L.	601.00

Hone finished. If polished add \$52.20

No. 5081

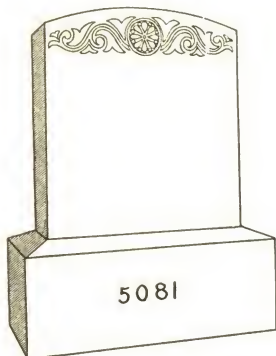

Die. 2.2 x 0.10 x 2.4 . . . 4.3
 B. Base. 2.8 x 1.4 x 1.0 . . . 3.7

Weight complete 1350 lbs.; no B. B. 700 lbs.

C.	\$79.50
D.	70.00
F.	66.00
G.	64.00
H.	61.50
I.	59.50
K.	56.50
L.	53.00

If B. B. is omitted deduct \$12.55
 Face only polished; balance sand finished

No. 5081½

Die. 1.10 x 0.6 x 2.0 . . . 1.10
 B. Base. 2.4 x 1.0 x 0.10 . . . 1.11

Weight complete 650 lbs.; no B. B. 300 lbs.

C.	\$41.50
D.	37.50
F.	35.50
G.	34.75
H.	33.75
I.	32.75
K.	31.50
L.	30.00

If B. B. is omitted deduct \$6.90
 Face only polished; balance sand finished

No. 5081¼

Die. 2.0 x 0.8 x 2.2 . . . 2.11
 B. Base. 2.6 x 1.2 x 1.0 . . . 2.11

Weight complete 1000 lbs.; no B. B. 475 lbs.

C.	\$61.00
D.	54.50
F.	51.50
G.	50.00
H.	48.50
I.	47.25
K.	45.00
L.	42.75

If B. B. is omitted deduct \$10.50
 Face only polished; balance sand finished

No. 5081½

See previous Column

No. 5082

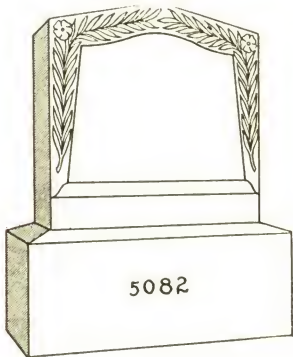

Die.....2. 4 x 0.10 x 2.4 .4.6
 B. Base.....2.10 x 1. 4 x 1.0 .3.9
 Weight complete 1400 lbs.; no B. B. 725 lbs.

C.....	\$88.00
D.....	78.00
F.....	73.50
G.....	71.00
H.....	69.00
I.....	66.50
K.....	63.00
L.....	60.00

If B. B. is omitted deduct \$13.15
 Face only polished; balance sand finished

No. 5083

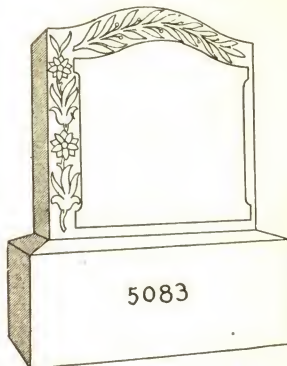

Die.....2. 4 x 0.10 x 2.4 .4.6
 B. Base.....2.10 x 1. 4 x 1.0 .3.9
 Weight complete 1400 lbs.; no B. B. 725 lbs.

C.....	\$89.00
D.....	79.00
F.....	74.50
G.....	72.00
H.....	70.00
I.....	67.50
K.....	64.00
L.....	61.00

If B. B. is omitted deduct \$13.15
 Face only polished; balance sand finished

No. 5082¹/₄

Die.....2.2 x 0.8 x 2.2 .3.2
 B. Base.....2.8 x 1.2 x 1.0 .3.1
 Weight complete 1050 lbs.; no B. B. 495 lbs.

C.....	\$67.50
D.....	60.50
F.....	57.50
G.....	56.00
H.....	54.50
I.....	52.50
K.....	50.50
L.....	48.00

If B. B. is omitted deduct \$10.80
 Face only polished; balance sand finished

No. 5083¹/₄

Die.....2.2 x 0.8 x 2.2 .3.2
 B. Base.....2.8 x 1.2 x 1.0 .3.1
 Weight complete 1050 lbs.; no B. B. 495 lbs.

C.....	\$68.50
D.....	61.50
F.....	58.50
G.....	57.00
H.....	55.50
I.....	53.50
K.....	51.50
L.....	49.00

If B. B. is omitted deduct \$10.80
 Face only polished; balance sand finished

No. 5082¹/₂

Die.....2.0 x 0.6 x 2.0 .2.0
 B. Base.....2.6 x 1.0 x 0.10 .2.1
 Weight complete 700 lbs.; no B. B. 325 lbs.

C.....	\$46.50
D.....	42.00
F.....	40.00
G.....	39.00
H.....	38.00
I.....	37.00
K.....	35.50
L.....	34.00

If B. B. is omitted deduct \$7.50
 Face only polished; balance sand finished

No. 5083¹/₂

Die.....2.0 x 0.6 x 2.0 .2.0
 B. Base.....2.6 x 1.0 x 0.10 .2.1
 Weight complete 700 lbs.; no B. B. 325 lbs.

C.....	\$48.00
D.....	43.50
F.....	41.50
G.....	40.50
H.....	39.50
I.....	37.50
K.....	37.00
L.....	35.50

If B. B. is omitted deduct \$7.50
 Face only polished; balance sand finished

No. 5086

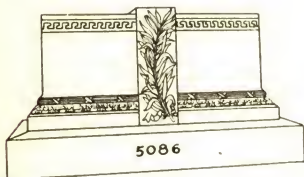

Die.....4.10 x 1.7 x 2.2..16.7
 B. Base....5. 6 x 2.2 x 0.8.. 7.11

Weight complete 3900 lbs.

C.....	\$561.00
D.....	523.00
F.....	507.00
G.....	498.00
H.....	490.00
I.....	482.00
K.....	469.00
L.....	457.00

No. 5086¹/₄

Die.....4.10 x 1.5 x 2.2..14.10
 B. Base....5. 6 x 2.0 x 0.8.. 7.4

Weight complete 3500 lbs.

C.....	\$513.00
D.....	479.00
F.....	465.00
G.....	457.00
H.....	450.00
I.....	442.00
K.....	431.00
L.....	420.00

No. 5086¹/₂

Die.....4.10 x 1. 3 x 2.2..13.1
 B. Base....5. 6 x 1.10 x 0.8.. 6.9

Weight complete 3200 lbs.

C.....	\$452.00
D.....	423.00
F.....	409.00
G.....	403.00
H.....	396.00
I.....	390.00
K.....	380.00
L.....	370.00

No. 5087

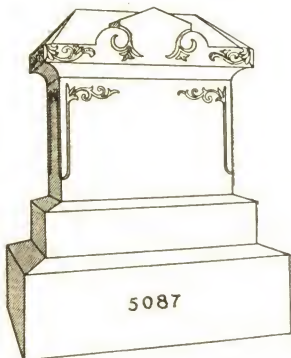

Cap.....3.1 x 1.7 x 1. 0. .4.11
 Die.....2.8 x 1.2 x 1. 8. .5.2

Base.....3.0 x 1.6 x 0.10. .3.9
 B. Base....3.8 x 2.2 x 1. 2. .9.3

Weight complete 3800 lbs.; no B.B. 2135 lbs.

C.....	\$259.00
D.....	228.00
F.....	214.00
G.....	207.00
H.....	200.00
I.....	193.00
K.....	183.00
L.....	173.00

If B. B. is omitted deduct \$32.40

No. 5087¹/₄

Cap.....2.10 x 1. 4 x 1.0. .3.9
 Die.....2. 6 x 1. 0 x 1.6. .3.9

Base.....2.10 x 1. 4 x 0.8. .2.6
 B. Base....3. 4 x 1.10 x 1.2. .7.2

Weight complete 2900 lbs.; no B.B.1610 lbs.

C.....	\$199.00
D.....	176.00
F.....	166.00
G.....	161.00
H.....	156.00
I.....	151.00
K.....	144.00
L.....	136.00

If B. B. is omitted deduct \$25.10

No. 5089

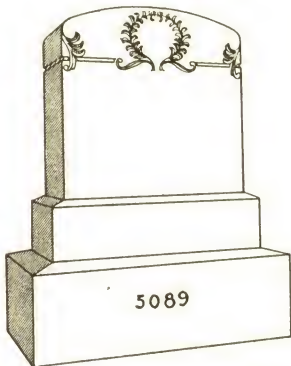

Die.....2.8 x 1.2 x 2.8..8.4
 Base.....3.1 x 1.7 x 0.8..3.3
 B. Base.....3.8 x 2.2 x 1.2..9.3
 Weight complete 3600 lbs.; no B.B.1835 lbs.
 G.....\$174.00
 H.....168.00
 I.....162.00
 K.....153.00
 L.....144.00
 If B. B. is omitted deduct \$32.40

No. 5089¹/₄

Die.....2.6 x 1.0 x 2.6..6.3
 Base.....2.10 x 1.4 x 0.8..2.6
 B. Base.....3.4 x 1.10 x 1.2..7.2
 Weight complete 2750 lbs.; no B.B.1460 lbs.
 G.....\$128.00
 H.....124.00
 I.....120.00
 K.....113.00
 L.....106.00
 If B. B. is omitted deduct \$25.10

No. 5089¹/₂

Die.....2.4 x 0.10 x 2.4..4.6
 Base.....2.8 x 1.2 x 0.8..2.1
 B. Base.....3.2 x 1.8 x 1.0..5.3
 Weight complete 2000 lbs.; no B.B.1055 lbs.
 G.....\$100.00
 H.....97.00
 I.....94.00
 K.....89.00
 L.....84.00
 If B. B. is omitted deduct \$18.40

No. 5089³/₄

Die.....2.2 x 0.8 x 2.2..3.2
 Base.....2.6 x 1.0 x 0.8..1.8
 B. Base.....3.0 x 1.6 x 1.0..4.6
 Weight complete 1600 lbs.; no B. B. 790 lbs.
 G.....\$78.00
 H.....76.00
 I.....73.50
 K.....69.50
 L.....66.00
 If B. B. is omitted deduct \$15.75

No. 5090

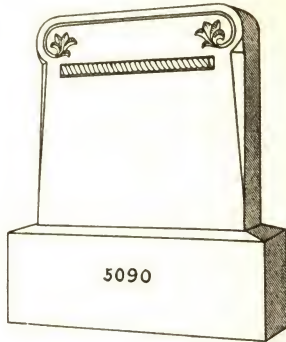

Die.....2.6 x 1.0 x 2.6..6.3
 B. Base.....3.0 x 1.6 x 1.2..5.3
 Weight complete 2000 lbs.; no B.B.1055 lbs.
 C.....\$115.00
 D.....101.00
 F.....94.50
 G.....91.50
 H.....88.00
 I.....85.00
 K.....80.50
 L.....75.50
 If B. B. is omitted deduct \$18.40

No. 5090¹/₄

Die.....2.4 x 0.10 x 2.4..4.6
 B. Base.....2.10 x 1.4 x 1.0..3.9
 Weight complete 1450 lbs.; no B. B. 775 lbs.
 C.....\$82.00
 D.....72.00
 F.....67.50
 G.....65.00
 H.....63.00
 I.....60.50
 K.....57.00
 L.....54.00
 If B. B. is omitted deduct \$13.15

No. 5090¹/₂

Die.....2.2 x 0.8 x 2.2..3.2
 B. Base.....2.8 x 1.2 x 0.10..2.7
 Weight complete 1000 lbs.; no B. B. 535 lbs.
 C.....\$60.00
 D.....53.00
 F.....50.00
 G.....48.25
 H.....46.75
 I.....45.25
 K.....42.75
 L.....40.50
 If B. B. is omitted deduct \$9.30

No. 5095

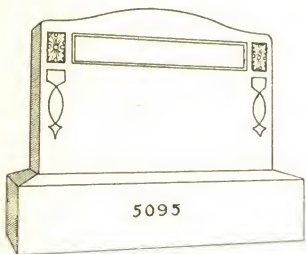

Die.....2.6 x 1.0 x 1.8..4.2
 B. Base.....3.0 x 1.6 x 0.8..3.0
 Weight complete 1200 lbs.; no B. B. 660 lbs.

C.....	\$86.00
D.....	76.50
F.....	72.50
G.....	70.50
H.....	68.50
I.....	66.00
K.....	63.00
L.....	60.00

If B. B. is omitted deduct \$10.80
 Face only polished; balance sand finished.
 If all polished add \$4.75.

No. 5095¹/₄

Die.....2.6 x 0.10 x 1.8..3.6
 B. Base.....3.0 x 1.4 x 0.8..2.8
 Weight complete 1050 lbs.; no B. B. 550 lbs.

C.....	\$74.50
D.....	66.50
F.....	63.50
G.....	61.50
H.....	60.00
I.....	58.00
K.....	55.50
L.....	53.00

If B. B. is omitted deduct \$9.60
 Face only polished; balance sand finished.
 If all polished add \$4.00.

No. 5095¹/₂

Die.....2.6 x 0.8 x 1.8..2.9
 B. Base.....3.0 x 1.2 x 0.8..2.4
 Weight complete 900 lbs.; no B. B. 480 lbs.

C.....	\$64.00
D.....	58.00
F.....	55.00
G.....	54.00
H.....	52.50
I.....	51.00
K.....	49.00
L.....	46.75

If B. B. is omitted deduct \$8.40
 Face only polished; balance sand finished.
 If all polished add \$3.50.

No. 5101

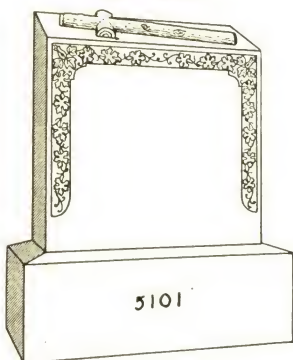

Die.....2.6 x 1.0 x 2.8..6.8
 B. Base.....3.0 x 1.6 x 1.0..4.6
 Weight complete 1900 lbs.; no B. B. 1090 lbs.

C.....	\$125.00
D.....	110.00
F.....	104.00
G.....	100.00
H.....	97.00
I.....	93.50
K.....	88.50
L.....	83.50

If B. B. is omitted deduct \$15.75

No. 5101¹/₄

Die.....2.4 x 0.10 x 2.6..4.10
 B. Base.....2.10 x 1.4 x 1.0..3.9
 Weight complete 1500 lbs.; no B. B. 825 lbs.

C.....	\$95.50
D.....	84.50
F.....	79.50
G.....	77.00
H.....	75.00
I.....	72.50
K.....	68.50
L.....	65.00

If B. B. is omitted deduct \$13.15

No. 5101¹/₂

Die.....2.2 x 0.8 x 2.4..3.4
 B. Base.....2.8 x 1.2 x 0.10..2.7
 Weight complete 1000 lbs.; no B. B. 535 lbs.

C.....	\$70.00
D.....	62.50
F.....	59.50
G.....	57.50
H.....	56.00
I.....	54.50
K.....	51.00
L.....	49.25

If B. B. is omitted deduct \$9.30

No. 5102

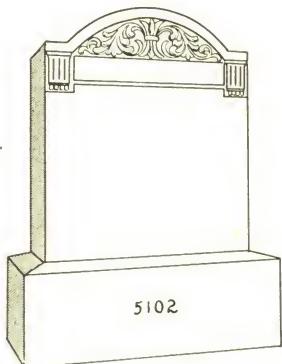

Die.....2. 4 x 0.10 x 2.8. .5.2
 B. Base.....2.10 x 1. 4 x 1.0. .3.9
 Weight complete 1575 lbs.; no B. B. 850 lbs.
 C.....\$107.00
 D.....95.50
 F.....90.50
 G.....88.00
 H.....85.50
 I.....82.50
 K.....79.00
 L.....75.00
 If B. B. is omitted deduct \$13.15
 Top sanded

No. 5103

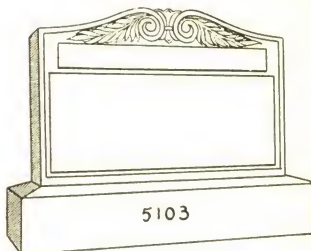

Die.....3.0 x 0.10 x 2. 0. .5. 0
 B. Base.....3.6 x 1. 4 x 0.10. .3.11
 Weight complete 1500 lbs.; no B. B. 795 lbs.
 C.....\$124.00
 D.....113.00
 F.....108.00
 G.....105.00
 H.....103.00
 I.....100.00
 K.....96.50
 L.....92.50
 If B. B. is omitted deduct \$13.70
 Face only polished; balance sanded

No. 5102¹/₄

Die.....2.2 x 0.8 x 2.6. .3.7
 B. Base.....2.8 x 1.2 x 1.0. .3.1
 Weight complete 1100 lbs.; no B. B. 545 lbs
 C.....\$84.50
 D.....76.50
 F.....72.50
 G.....71.00
 H.....69.00
 I.....67.50
 K.....64.50
 L.....62.00
 If B. B. is omitted deduct \$10.80
 Top sanded

No. 5103¹/₄

Die.....3.0 x 0.8 x 2. 0. .4. 0
 B. Base.....3.6 x 1.2 x 0.10. .3.5
 Weight complete 1250 lbs.; no B. B. 635 lbs.
 C.....\$106.00
 D.....96.50
 F.....92.50
 G.....90.50
 H.....88.50
 I.....86.50
 K.....83.50
 L.....80.50
 If B. B. is omitted deduct \$11.95
 Face only polished; balance sanded

No. 5102¹/₂

Die.....2.0 x 0.6 x 2. 4. .2.4
 B. Base.....2.6 x 1.0 x 0.10. .2.1
 Weight complete 725 lbs.; no B. B. 350 lbs
 C.....\$63.50
 D.....58.00
 F.....56.00
 G.....54.50
 H.....53.50
 I.....52.50
 K.....50.50
 L.....48.75
 If B. B. is omitted deduct \$7.50
 Top sanded

No. 5103¹/₂

Die.....3.0 x 0.6 x 2. 0. .3. 0
 B. Base.....3.6 x 1.0 x 0.10. .2.11
 Weight complete 1000 lbs.; no B. B. 475 lbs.
 C.....\$89.00
 D.....82.00
 F.....79.00
 G.....78.00
 H.....76.00
 I.....74.50
 K.....72.50
 L.....70.00
 If B. B. is omitted deduct \$10.50
 Face only polished; balance sanded

No. 5106



Urn.....0.11 x 0.11 x 0.10..0.8
 Die.....3.6 x 1.0 x 2.6..8.9
 B. Base...4.2 x 1.8 x 1.0..6.11

Weight complete 2600 lbs.; no B.B.1355 lbs.

- C.....\$202.00
- D.....181.00
- F.....171.00
- G.....167.00
- H.....162.00
- I.....157.00
- K.....150.00
- L.....143.00

If B. B. is omitted deduct \$24.20
 All sand finished

No. 5106¹/₄

Urn.....0.9 x 0.9 x 0.8..0.5
 Die.....3.6 x 0.10 x 2.6..7.4
 B. Base....4.2 x 1.6 x 1.0..6.3

Weight complete 2200 lbs.; no B.B.1075 lbs.

- C.....\$178.00
- D.....161.00
- F.....153.00
- G.....149.00
- H.....145.00
- I.....142.00
- K.....136.00
- L.....130.00

If B. B. is omitted deduct \$21.90
 All sand finished

No. 5110

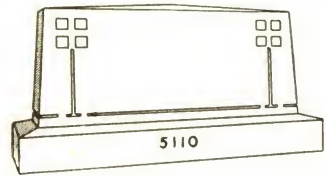

Die.....3.10 x 1.0 x 1.8..6.5
 B. Base....4.4 x 1.6 x 0.8..4.4

Weight complete 1700 lbs.; no B. B. 920 lbs.

- C.....\$122.00
- D.....107.00
- F.....101.00
- G.....97.50
- H.....94.50
- I.....91.00
- K.....86.50
- L.....81.50

If B. B. is omitted deduct \$15.15
 All sand finished

No. 5110¹/₄

Die.....3.10 x 0.10 x 1.8..5.4
 B. Base....4.4 x 1.4 x 0.8..3.10

Weight complete 1500 lbs.; no B. B. 810 lbs.

- C.....\$102.00
- D.....89.50
- F.....84.50
- G.....81.50
- H.....79.00
- I.....76.50
- K.....72.50
- L.....68.50

If B. B. is omitted deduct \$13.40
 All sand finished

No. 5110¹/₂

Die.....3.10 x 0.8 x 1.8..4.3
 B. Base....4.4 x 1.2 x 0.8..3.4

Weight complete 1250 lbs.; no B. B. 650 lbs.

- C.....\$82.00
- D.....72.50
- F.....68.50
- G.....66.50
- H.....64.00
- I.....62.00
- K.....59.00
- L.....55.50

If B. B. is omitted deduct \$11.65
 All sand finished

No. 5112

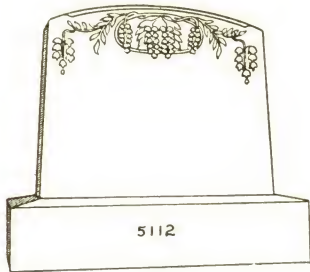

Die.....3.0 x 0.8 x 2. 4. 4.8
 B. Base.....3.8 x 1.2 x 0.10. .3.7
 Weight complete 1300 lbs.; no B. B. 655 lbs.

C.....	\$103.00
D.....	93.00
F.....	88.00
G.....	86.00
H.....	83.50
I.....	81.00
K.....	77.50
L.....	74.00

If B. B. is omitted deduct \$12.50

No. 5114

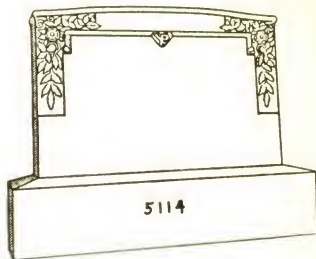

Die.....3.6 x 1.0 x 2.4. .8.2
 B. Base.....4.2 x 1.8 x 1.2. .8.1
 Weight complete 2750 lbs.; no B. B. 1295 lbs.

C.....	\$198.00
D.....	180.00
F.....	172.00
G.....	168.00
H.....	164.00
I.....	160.00
K.....	154.00
L.....	147.00

If B. B. is omitted deduct \$28.30

No. 5112¹/₄

Die.....2.10 x 0.6 x 2. 2. 3. 1
 B. Base.....3. 6 x 1.0 x 0.10. .2.11
 Weight complete 950 lbs.; no B. B. 425 lbs.

C.....	\$79.00
D.....	72.00
F.....	69.00
G.....	67.50
H.....	66.00
I.....	64.50
K.....	62.00
L.....	59.50

If B. B. is omitted deduct \$10.50

No. 5114¹/₄

Die.....3.6 x 0.10 x 2.4. .6.10
 B. Base.....4.2 x 1. 6 x 1.0. .6. 3
 Weight complete 2200 lbs.; no B. B. 1075 lbs.

C.....	\$173.00
D.....	157.00
F.....	151.00
G.....	147.00
H.....	144.00
I.....	140.00
K.....	135.00
L.....	130.00

If B. B. is omitted deduct \$21.90

No. 5112¹/₂

Die.....2.8 x 0.4 x 2.0. .1.9
 B. Base.....3.2 x 0.8 x 0.8. .1.5
 Weight complete 525 lbs.; no B. B. 270 lbs.

C.....	\$52.00
D.....	48.25
F.....	46.25
G.....	45.50
H.....	44.50
I.....	43.75
K.....	42.50
L.....	41.00

If B. B. is omitted deduct \$5.10

No. 5114¹/₂

Die.....3.6 x 0.8 x 2.4. .5.5
 B. Base.....4.2 x 1.4 x 1.0. .5.7
 Weight complete 1850 lbs.; no B. B. 845 lbs.

C.....	\$149.00
D.....	137.00
F.....	131.00
G.....	129.00
H.....	126.00
I.....	123.00
K.....	119.00
L.....	115.00

If B. B. is omitted deduct \$19.55

No. 5117

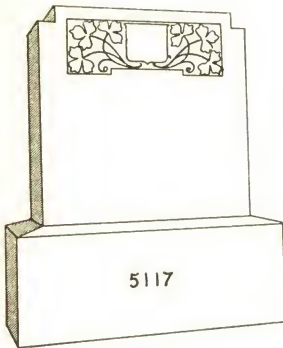

Die.....2.6 x 1.0 x 2.6..6.3
 B. Base.....3.0 x 1.6 x 1.2..5.3
 Weight complete 2000 lbs.; no B.B.1055 lbs.

C.....	\$109.00
D.....	94.50
F.....	88.50
G.....	85.50
H.....	82.00
I.....	79.00
K.....	74.50
L.....	69.50

If B. B. is omitted deduct \$18.40
 Face only polished; balance sand finished

No. 5117¹/₄

Die.....2.4 x 0.10 x 2.4..4.6
 B. Base.....2.10 x 1.4 x 1.0..3.9
 Weight complete 1475 lbs.; no B. B. 780 lbs.

C.....	\$79.50
D.....	69.50
F.....	65.00
G.....	62.50
H.....	60.50
I.....	58.00
K.....	54.50
L.....	51.50

If B. B. is omitted deduct \$13.15
 Face only polished; balance sand finished

No. 5117¹/₂

Die.....2.0 x 0.8 x 2.0..2.8
 B. Base.....2.6 x 1.2 x 1.0..2.11
 Weight complete 1000 lbs.; no B. B. 475 lbs.

C.....	\$52.00
D.....	45.75
F.....	43.25
G.....	41.75
H.....	40.50
I.....	39.25
K.....	37.25
L.....	35.25

If B. B. is omitted deduct \$10.50
 Face only polished; balance sand finished

No. 5118

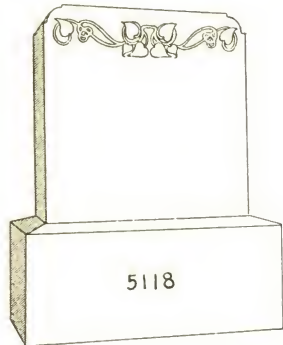

Die.....2.6 x 1.0 x 2.6..6.3
 B. Base.....3.0 x 1.6 x 1.2..5.3
 Weight complete 2000 lbs.; no B.B.1055 lbs.

C.....	\$109.00
D.....	94.50
F.....	88.50
G.....	85.50
H.....	82.00
I.....	79.00
K.....	74.50
L.....	69.50

If B. B. is omitted deduct \$18.40
 Face only polished; balance sand finished

No. 5118¹/₄

Die.....2.4 x 0.10 x 2.4..4.6
 B. Base.....2.10 x 1.4 x 1.0..3.9
 Weight complete 1475 lbs.; no B. B. 780 lbs.

C.....	\$79.50
D.....	69.50
F.....	65.00
G.....	62.50
H.....	60.50
I.....	58.00
K.....	54.50
L.....	51.50

If B. B. is omitted deduct \$13.15
 Face only polished; balance sand finished

No. 5118¹/₂

Die.....2.0 x 0.8 x 2.0..2.8
 B. Base.....2.6 x 1.2 x 1.0..2.11
 Weight complete 1000 lbs.; no B. B. 475 lbs.

C.....	\$52.00
D.....	45.75
F.....	43.25
G.....	41.75
H.....	40.50
I.....	39.25
K.....	37.25
L.....	35.25

If B. B. is omitted deduct \$10.50
 Face only polished; balance sand finished

No. 5119

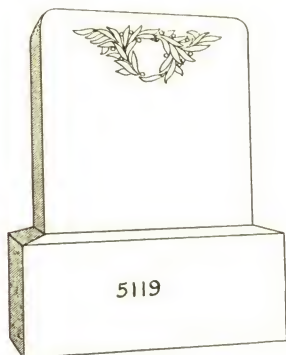

Die.....2.6 x 1.0 x 2.6..6.3
 B. Base.....3.0 x 1.6 x 1.2..5.3

Weight complete 2000 lbs.; no B.B.1055 lbs.

- C.....\$109.00
- D.....94.50
- F.....88.50
- G.....85.50
- H.....82.00
- I.....79.00
- K.....74.50
- L.....69.50

If B. B. is omitted deduct \$18.40
 Face only polished; balance sand finished

No. 5119¹/₄

Die.....2.4 x 0.10 x 2.4..4.6
 B. Base....2.10 x 1.4 x 1.0..3.9

Weight complete 1475 lbs.; no B. B. 780 lbs.

- C.....\$79.50
- D.....69.50
- F.....65.00
- G.....62.50
- H.....60.50
- I.....58.00
- K.....54.50
- L.....51.50

If B. B. is omitted deduct \$13.15
 Face only polished; balance sand finished

No. 5119¹/₂

Die.....2.0 x 0.8 x 2.0..2.8
 B. Base.....2.6 x 1.2 x 1.0..2.11

Weight complete 1000 lbs.; no B. B. 475 lbs.

- C.....\$52.00
- D.....45.75
- F.....43.25
- G.....41.75
- H.....40.50
- I.....39.25
- K.....37.25
- L.....35.25

If B. B. is omitted deduct \$10.50
 Face only polished; balance sand finished

No. 5120

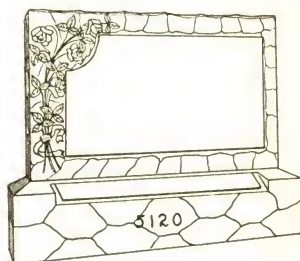

Die.....3.8 x 1.0 x 2.4..8.7
 B. Base.....4.2 x 1.6 x 1.0..6.3

Weight complete 2670 lbs.

- Rutland White,
 Riv., S. F., Blue
 or P. V.....\$140.00

No. 5120¹/₄

Die.....3.8 x 0.10 x 2.4..7.2
 B. Base.....4.2 x 1.4 x 1.0..5.7

Weight complete 2300 lbs.

- Rutland White,
 Riv., S. F., Blue
 or P. V.....\$124.00

No. 5120¹/₂

Die.....3.8 x 0.8 x 2.4..5.8
 B. Base.....4.2 x 1.2 x 1.0..4.10

Weight complete 1890 lbs.

- Rutland White,
 Riv., S. F., Blue.
 or P. V.....\$116.00

No. 5122

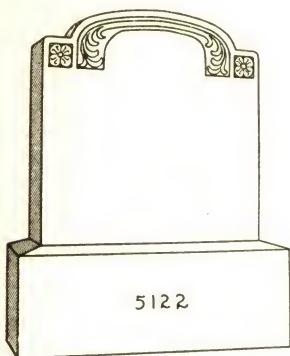

Die.....2.6 x 1.0 x 2.6 .6.3
 B. Base.....3.0 x 1.6 x 1.2 .5.3
 Weight complete 2070 lbs.; no B. B. 1125 lbs.
 C.....\$122.00
 D.....108.00
 F.....102.00
 G.....99.00
 H.....95.50
 I.....92.50
 K.....88.00
 L.....83.00
 If B. B. is omitted deduct \$18.40

No. 5122¹/₄

Die.....2.4 x 0.10 x 2.4 .4.6
 B. Base.....2.10 x 1.4 x 1.0 .3.9
 Weight complete 1485 lbs.; no B. B. 810 lbs.
 C.....\$90.50
 D.....80.50
 F.....76.00
 G.....73.50
 H.....71.50
 I.....69.00
 K.....65.50
 L.....62.50
 If B. B. is omitted deduct \$13.15

No. 5122¹/₂

Die.....2.0 x 0.8 x 2.0 .2.8
 B. Base.....2.6 x 1.2 x 1.0 .2.11
 Weight complete 1000 lbs.; no B. B. 480 lbs.
 C.....\$61.50
 D.....55.50
 F.....52.50
 G.....51.50
 H.....50.00
 I.....48.75
 K.....46.75
 L.....44.75
 If B. B. is omitted deduct \$10.50

No. 5123

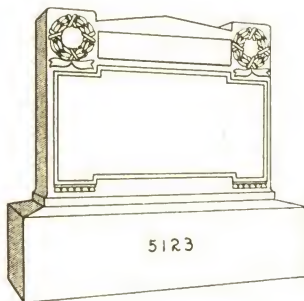

Die.....3.6 x 1.0 x 2.8 .9.4
 B. Base.....4.2 x 1.8 x 1.2 .8.1
 Weight complete 3155 lbs.; no B. B. 1680 lbs.
 C.....\$201.00
 D.....180.00
 F.....171.00
 G.....166.00
 H.....161.00
 I.....156.00
 K.....149.00
 L.....142.00
 If B. B. is omitted deduct \$28.30
 Face of panels only polished; balance sand finished. Carving raised ¹/₄ inch.

No. 5123¹/₄

Die.....3.4 x 0.10 x 2.6 .6.11
 B. Base.....4.0 x 1.6 x 1.0 .6.0
 Weight complete 2325 lbs.; no B. B. 1245 lbs.
 C.....\$157.00
 D.....141.00
 F.....134.00
 G.....131.00
 H.....128.00
 I.....125.00
 K.....120.00
 L.....115.00
 If B. B. is omitted deduct \$21.00
 Face of panels only polished; balance sand finished. Carving raised ¹/₄ inch.

No. 5123¹/₂

Die.....3.2 x 0.8 x 2.4 .4.11
 B. Base.....3.8 x 1.2 x 1.0 .4.3
 Weight complete 1650 lbs.; no B. B. 885 lbs.
 C.....\$121.00
 D.....110.00
 F.....105.00
 G.....103.00
 H.....101.00
 I.....98.50
 K.....95.00
 L.....91.50
 If B. B. is omitted deduct \$14.90.
 Face of panels only polished, balance sand finished. Carving raised ¹/₄ inch.

No. 5124

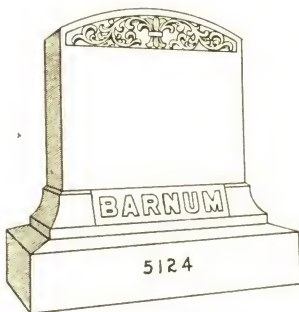

Die.....3.0 x 1.2 x 2.10 .9.11
 Base.....3.6 x 1.8 x 0.8 .3.11
 B. Base....4.2 x 2.4 x 1.0 .9.9
 Weight complete 4245 lbs.; no B.B.2490 lbs.
 D.....\$246.00
 H.....218.00
 I.....211.00
 K.....201.00
 L.....191.00
 If B. B. is omitted deduct \$34.15

No. 5124¹/₄

Die.....2.10 x 1.0 x 2.8 .7.7
 Base.....3.4 x 1.6 x 0.8 .3.4
 B. Base....4.0 x 2.2 x 1.0 .8.8
 Weight complete 3525 lbs.; no B.B.1965 lbs.
 D.....\$194.00
 H.....173.00
 I.....167.00
 K.....159.00
 L.....151.00
 If B. B. is omitted deduct \$30.35

No. 5124¹/₂

Die.....2.6 x 0.10 x 2.4 .4.10
 Base.....3.0 x 1.4 x 0.8 .2.8
 B. Base....3.8 x 2.0 x 1.0 .7.4
 Weight complete 2670 lbs.; no B.B.1350 lbs.
 D.....\$146.00
 H.....131.00
 I.....127.00
 K.....121.00
 L.....116.00
 If B. B. is omitted deduct \$25.65

No. 5124³/₄

Die.....2.4 x 0.8 x 2.2 .3.4
 Base.....2.8 x 1.0 x 0.8 .1.9
 B. Base....3.2 x 1.6 x 1.0 .4.9
 Weight complete 1770 lbs.; no B. B. 915 lbs.
 D.....\$106.00
 H.....94.00
 I.....91.00
 K.....86.50
 L.....81.50
 If B. B. is omitted deduct \$16.65

No. 5129

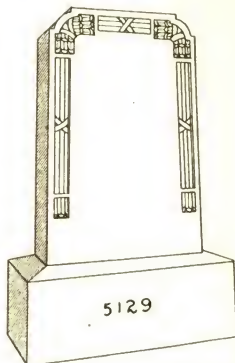

Die.....2.6 x 1.0 x 3.8 .9.2
 B. Base.....3.2 x 1.8 x 1.2 .6.2
 Weight complete 2760 lbs.; no B.B.1650 lbs.
 C.....\$192.00
 D.....172.00
 F.....162.00
 G.....158.00
 H.....153.00
 I.....149.00
 K.....142.00
 L.....135.00
 If B. B. is omitted deduct \$21.60

No. 5129¹/₄

Die.....2.4 x 0.10 x 3.6 .6.10
 B. Base....3.0 x 1.6 x 1.2 .5.3
 Weight complete 2175 lbs.; no B.B.1230 lbs.
 C.....\$155.00
 D.....139.00
 F.....133.00
 G.....129.00
 H.....126.00
 I.....122.00
 K.....117.00
 L.....112.00
 If B. B. is omitted deduct \$18.40

No. 5129¹/₂

Die.....2.4 x 0.8 x 3.6 .5.5
 B. Base....3.0 x 1.4 x 1.2 .4.8
 Weight complete 1815 lbs.; no B. B. 975 lbs.
 C.....\$132.00
 D.....120.00
 F.....114.00
 G.....112.00
 H.....109.00
 I.....106.00
 K.....102.00
 L.....98.00
 If B. B. is omitted deduct \$16.35

No. 5133

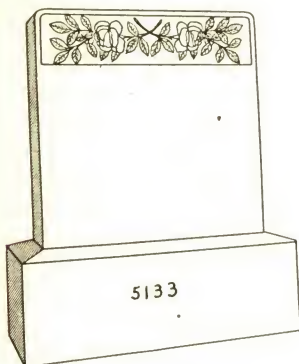

Die.....2. 4 x 0.10 x 2.4. .4.6
 B. Base.....2.10 x 1. 4 x 1.0. .3.9
 Weight complete 1400 lbs.; no B. B. 725 lbs.

C.....	\$80.50
D.....	70.00
F.....	66.00
G.....	63.50
H.....	61.50
I.....	59.00
K.....	55.50
L.....	52.50

If B. B. is omitted deduct \$13.15

No. 5134

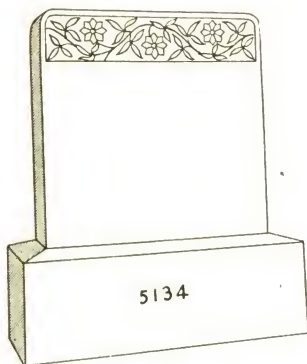

Die.....2. 4 x 0.10 x 2.4. .4.6
 B. Base.....2.10 x 1. 4 x 1.0. .3.9
 Weight complete 1400 lbs.; no B. B. 725 lbs.

C.....	\$80.50
D.....	70.00
F.....	66.00
G.....	63.50
H.....	61.50
I.....	59.00
K.....	55.50
L.....	52.50

If B. B. is omitted deduct \$13.15

No. 5133¹/₄

Die.....2.2 x 0.8 x 2.2. .3.2
 B. Base.....2.8 x 1.2 x 1.0. .3.1
 Weight complete 1050 lbs.; no B. B. 495 lbs.

C.....	\$59.00
D.....	52.00
F.....	49.00
G.....	47.25
H.....	45.75
I.....	44.25
K.....	41.75
L.....	39.50

If B. B. is omitted deduct \$10.80

No. 5134¹/₄

Die.....2.2 x 0.8 x 2.2. .3.2
 B. Base.....2.8 x 1.2 x 1.0. .3.1
 Weight complete 1050 lbs.; no B. B. 495 lbs.

C.....	\$59.00
D.....	52.00
F.....	49.00
G.....	47.25
H.....	45.75
I.....	44.25
K.....	41.75
L.....	39.50

If B. B. is omitted deduct \$10.80

No. 5133¹/₂

Die.....2.0 x 0.6 x 2.0. .2.0
 B. Base.....2.6 x 1.0 x 0.10. .2.1
 Weight complete 700 lbs.; no B. B. 325 lbs.

C.....	\$39.50
D.....	35.00
F.....	33.00
G.....	32.00
H.....	31.00
I.....	30.00
K.....	28.50
L.....	27.00

If B. B. is omitted deduct \$7.50

No. 5134¹/₂

Die.....2.0 x 0.6 x 2.0. .2.0
 B. Base.....2.6 x 1.0 x 0.10. .2.1
 Weight complete 700 lbs.; no B. B. 325 lbs.

C.....	\$39.50
D.....	35.00
F.....	33.00
G.....	32.00
H.....	31.00
I.....	30.00
K.....	28.50
L.....	27.00

If B. B. is omitted deduct \$7.50

No. 5135

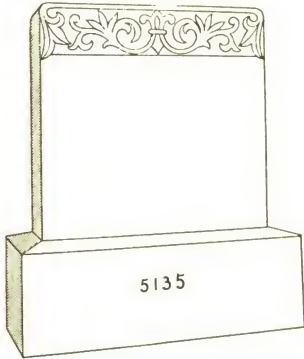

Die.....2. 4 x 0.10 x 2.4. .4.6
 B. Base.2.10 x 1. 4 x 1.0. .3.9
 Weight complete 1400 lbs.; no B. B. 725 lbs.

- C.....\$80.50
- D.....70.00
- F.....66.00
- G.....63.50
- H.....61.50
- I.....59.00
- K.....55.50
- L.....52.50

If B. B. is omitted deduct \$13.15

No. 5136

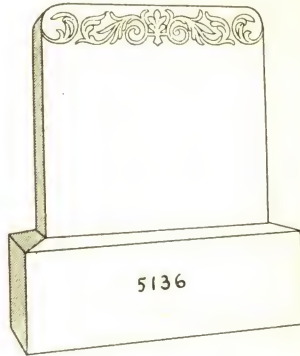

Die.....2. 4 x 0.10 x 2.4. .4.6
 B. Base.2.10 x 1. 4 x 1.0. .3.9
 Weight complete 1400 lbs.; no B. B. 725 lbs.

- C.....\$83.00
- D.....73.00
- F.....68.50
- G.....66.00
- H.....64.00
- I.....61.50
- K.....58.00
- L.....55.00

If B. B. is omitted deduct \$13.15

No. 5135¹/₄

Die.....2.2 x 0.8 x 2.2. .3.2
 B. Base.2.8 x 1.2 x 1.0. .3.1
 Weight complete 1050 lbs.; no B. B. 495 lbs.

- C.....\$59.00
- D.....52.00
- F.....49.00
- G.....47.25
- H.....45.75
- I.....44.25
- K.....41.75
- L.....39.50

If B. B. is omitted deduct \$10.80

No. 5136¹/₄

Die.....2.2 x 0.8 x 2.2. .3.2
 B. Base.2.8 x 1.2 x 1.0. .3.1
 Weight complete 1050 lbs.; no B. B. 495 lbs.

- C.....\$61.50
- D.....54.50
- F.....51.50
- G.....50.00
- H.....48.50
- I.....46.50
- K.....44.50
- L.....42.00

If B. B. is omitted deduct \$10.80

No. 5135¹/₂

Die.....2.0 x 0.6 x 2. 0. .2.0
 B. Base.2.6 x 1.0 x 0.10. .2.1
 Weight complete 700 lbs.; no B. B. 325 lbs.

- C.....\$39.50
- D.....35.00
- F.....33.00
- G.....32.00
- H.....31.00
- I.....30.00
- K.....28.50
- L.....27.00

If B. B. is omitted deduct \$7.50

No. 5136¹/₂

Die.....2.0 x 0.6 x 2. 0. .2.0
 B. Base.2.6 x 1.0 x 0.10. .2.1
 Weight complete 700 lbs.; no B. B. 325 lbs.

- C.....\$41.75
- D.....37.25
- F.....35.25
- G.....34.25
- H.....33.25
- I.....32.25
- K.....30.75
- L.....29.25

If B. B. is omitted deduct \$7.50

No. 5137

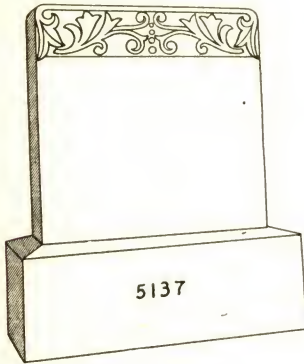

Die.....2. 4 x 0.10 x 2.4..4.6
 B. Base.....2.10 x 1. 4 x 1.0..3.9
 Weight complete 1400 lbs.; no B. B. 725 lbs.

- C.....\$80.50
- D.....70.00
- F.....66.00
- G.....63.50
- H.....61.50
- I.....59.00
- K.....55.50
- L.....52.50

If B. B. is omitted deduct \$13.15

No. 5137¹/₄

Die.....2.2 x 0.8 x 2.2..3.2
 B. Base.....2.8 x 1.2 x 1.0..3.1
 Weight complete 1050 lbs.; no B. B. 495 lbs.

- C.....\$59.00
- D.....52.00
- F.....49.00
- G.....47.25
- H.....45.75
- I.....44.25
- K.....41.75
- L.....39.50

If B. B. is omitted deduct \$10.80

No. 5137¹/₂

Die.....2.0 x 0.6 x 2. 0..2.0
 B. Base.....2.6 x 1.0 x 0.10..2.1
 Weight complete 700 lbs.; no B. B. 325 lbs.

- C.....\$39.50
- D.....35.00
- F.....33.00
- G.....32.00
- H.....31.00
- I.....30.00
- K.....28.50
- L.....27.00

If B. B. is omitted deduct \$7.50

No. 5139

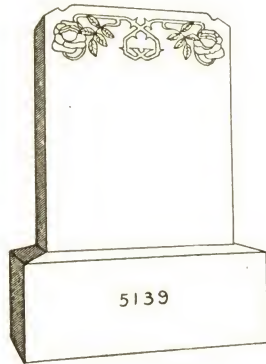

Die.....2. 4 x 0.10 x 2.8..5.2
 B. Base...2.10 x 1. 4 x 1.0..3.9
 Weight complete 1575 lbs.; no B. B. 855 lbs.

- C.....\$95.50
- D.....84.00
- F.....79.00
- G.....76.50
- H.....74.00
- I.....71.00
- K.....67.50
- L.....63.50

If B. B. is omitted deduct \$13.15
 Face only polished; balance sand finished

No. 5139¹/₄

Die.....2.0 x 0.8 x 2.6..3. 4
 B. Base.....2.6 x 1.2 x 1.0..2.11
 Weight complete 1050 lbs.; no B. B. 525 lbs.

- C.....\$66.50
- D.....59.00
- F.....56.00
- G.....54.00
- H.....52.50
- I.....51.00
- K.....48.25
- L.....45.75

If B. B. is omitted deduct \$10.50
 Face only polished; balance sand finished

No. 5139¹/₂

Die.....1.8 x 0.6 x 2. 4..1.11
 B. Base.....2.2 x 1.0 x 0.10..1.10
 Weight complete 650 lbs.; no B. B. 320 lbs.

- C.....\$41.75
- D.....37.50
- F.....35.50
- G.....34.50
- H.....33.50
- I.....32.75
- K.....31.25
- L.....29.75

If B. B. is omitted deduct \$6.60
 Face only polished; balance sand finished

No. 5140

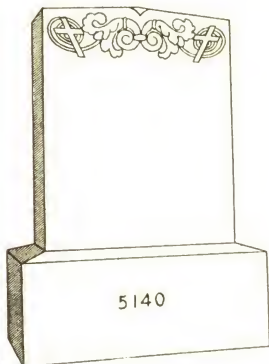

Die.....2. 4 x 0.10 x 2.8..5.2
 B. Base....2.10 x 1. 4 x 1.0..3.9
 Weight complete 1575 lbs.; no B. B. 855 lbs.

C.....	\$92.00
D.....	80.00
F.....	75.50
G.....	73.00
H.....	70.50
I.....	67.50
K.....	64.00
L.....	60.00

If B. B. is omitted deduct \$13.15
 Face only polished; balance sand finished

No. 5140¹/₄

Die.....2.0 x 0.8 x 2.6..3. 4
 B. Base....2.6 x 1.2 x 1.0..2.11
 Weight complete 1050 lbs.; no B. B. 525 lbs.

C.....	\$63.00
D.....	55.50
F.....	52.50
G.....	50.50
H.....	49.00
I.....	47.50
K.....	44.75
L.....	42.25

If B. B. is omitted deduct \$10.50
 Face only polished; balance sand finished

No. 5140¹/₂

Die.....1.8 x 0.6 x 2. 4..1.11
 B. Base....2.2 x 1.0 x 0.10..1.10
 Weight complete 650 lbs.; no B. B. 320 lbs.

C.....	\$38.25
D.....	34.00
F.....	32.00
G.....	31.00
H.....	30.00
I.....	29.25
K.....	27.75
L.....	26.25

If B. B. is omitted deduct \$6.60
 Face only polished; balance sand finished

No. 5141

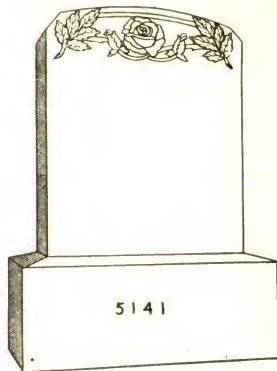

Die.....2. 4 x 0.10 x 2.8..5.2
 B. Base....2.10 x 1. 4 x 1.0..3.9
 Weight complete 1575 lbs.; no B. B. 855 lbs.

C.....	\$101.00
D.....	89.00
F.....	84.00
G.....	81.50
H.....	79.00
I.....	76.00
K.....	72.50
L.....	68.50

If B. B. is omitted deduct \$13.15
 Face only polished; balance sand finished

No. 5141¹/₄

Die.....2.0 x 0.8 x 2.6..3. 4
 B. Base....2.6 x 1.2 x 1.0..2.11
 Weight complete 1050 lbs.; no B. B. 525 lbs.

C.....	\$70.00
D.....	62.50
F.....	59.50
G.....	57.50
H.....	56.00
I.....	54.50
K.....	52.00
L.....	49.25

If B. B. is omitted deduct \$10.50
 Face only polished; balance sand finished

No. 5141¹/₂

Die.....1.8 x 0.6 x 2. 4..1.11
 B. Base....2.2 x 1.0 x 0.10..1.10
 Weight complete 650 lbs.; no B. B. 320 lbs.

C.....	\$45.25
D.....	41.00
F.....	39.00
G.....	38.00
H.....	37.00
I.....	36.25
K.....	34.75
L.....	33.25

If B. B. is omitted deduct \$6.60
 Face only polished; balance sand finished

No. 5142

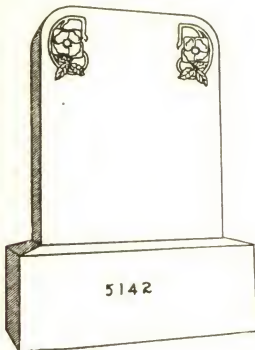

Die.....2. 4x0.10x2.8..5.2
 B. Base....2.10x1. 4x1.0..3.9
 Weight complete 1575 lbs.; no B. B. 855 lbs.

C.....	\$94.50
D.....	83.00
F.....	78.00
G.....	75.50
H.....	73.00
I.....	70.00
K.....	66.50
L.....	62.50

If B. B. is omitted deduct \$13.15
 Face only polished; balance sand finished

No. 5142¹/₄

Die.....2.0x0.8x2.6..3. 4
 B. Base....2.6x1.2x1.0..2.11
 Weight complete 1050 lbs.; no B. B. 525 lbs.

C.....	\$65.50
D.....	58.00
F.....	55.00
G.....	53.00
H.....	51.50
I.....	50.00
K.....	47.25
L.....	44.75

If B. B. is omitted deduct \$10.50
 Face only polished; balance sand finished

No. 5142¹/₂

Die.....1.8x0.6x2. 4..1.11
 B. Base....2.2x1.0x0.10..1.10
 Weight complete 650 lbs.; no B. B. 320 lbs.

C.....	\$39.25
D.....	35.00
F.....	33.00
G.....	32.00
H.....	31.00
I.....	30.25
K.....	28.75
L.....	27.25

If B. B. is omitted deduct \$6.60
 Face only polished; balance sand finished

No. 5143

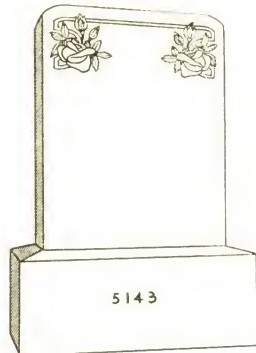

Die.....2. 4x0.10x2.8..5.2
 B. Base....2.10x1. 4x1.0..3.9
 Weight complete 1575 lbs.; no B. B. 855 lbs.

C.....	\$94.50
D.....	83.00
F.....	78.00
G.....	75.50
H.....	73.00
I.....	70.00
K.....	66.50
L.....	62.50

If B. B. is omitted deduct \$13.15
 Face only polished; balance sand finished

No. 5143¹/₄

Die.....2.0x0.8x2.6..3. 4
 B. Base....2.6x1.2x1.0..2.11
 Weight complete 1050 lbs.; no B. B. 525 lbs.

C.....	\$65.50
D.....	58.00
F.....	55.00
G.....	53.00
H.....	51.50
I.....	50.00
K.....	47.25
L.....	44.75

If B. B. is omitted deduct \$10.50
 Face only polished; balance sand finished

No. 5143¹/₂

Die.....1.8x0.6x2. 4..1.11
 B. Base....2.2x1.0x0.10..1.10
 Weight complete 650 lbs.; no B. B. 320 lbs.

C.....	\$39.25
D.....	35.00
F.....	33.00
G.....	32.00
H.....	31.00
I.....	30.25
K.....	28.75
L.....	27.25

If B. B. is omitted deduct \$6.60
 Face only polished; balance sand finished

No. 5144

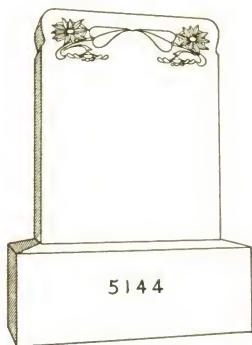

Die.....2. 4 x 0.10 x 2.8. .5.2
 B. Base....2.10 x 1. 4 x 1.0. .3.9
 Weight complete 1575 lbs.; no B. B. 855 lbs.

C.....	\$94.50
D.....	83.00
F.....	78.00
G.....	75.50
H.....	73.00
I.....	70.00
K.....	66.50
L.....	62.50

If B. B. is omitted deduct \$13.15
 Face only polished; balance sand finished

No. 5144¹/₄

Die.....2.0 x 0.8 x 2.6. .3. 4
 B. Base....2.6 x 1.2 x 1.0. .2.11
 Weight complete 1050 lbs.; no B. B. 525 lbs.

C.....	\$65.50
D.....	58.00
F.....	55.00
G.....	53.00
H.....	51.50
I.....	50.00
K.....	47.25
L.....	44.75

If B. B. is omitted deduct \$10.50
 Face only polished; balance sand finished

No. 5144¹/₂

Die.....1.8 x 0.6 x 2. 4. .1.11
 B. Base....2.2 x 1.0 x 0.10. .1.10
 Weight complete 650 lbs.; no B. B. 320 lbs.

C.....	\$39.25
D.....	35.00
F.....	33.00
G.....	32.00
H.....	31.00
I.....	30.25
K.....	28.75
L.....	27.25

If B. B. is omitted deduct \$6.60
 Face only polished; balance sand finished

No. 5147

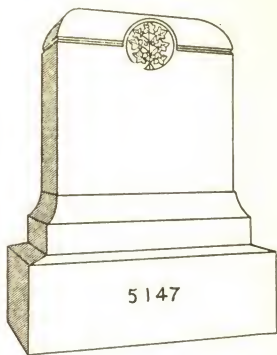

Die.....2. 6 x 1. 0 x 2.6. .6.3
 Base.....2.10 x 1. 4 x 0.8. .2.6
 B. Base....3. 4 x 1.10 x 1.2. .7.2
 Weight complete 2800 lbs.; no B.B.1510 lbs.

C.....	\$178.00
D.....	158.00
F.....	150.00
G.....	145.00
H.....	141.00
I.....	137.00
K.....	130.00
L.....	123.00

If B. B. is omitted deduct \$25.10

No. 5147¹/₄

Die.....2.4 x 0.10 x 2.4. .4.6
 Base.....2.8 x 1. 2 x 0.8. .2.1
 B. Base....3.2 x 1. 8 x 1.0. .5.3
 Weight complete 2000 lbs.; no B.B.1055 lbs.

C.....	\$142.00
D.....	127.00
F.....	121.00
G.....	117.00
H.....	114.00
I.....	111.00
K.....	106.00
L.....	101.00

If B. B. is omitted deduct \$18.40

No. 5147¹/₂

Die.....2.2 x 0.8 x 2.2. .3.2
 Base.....2.6 x 1.0 x 0.8. .1.8
 B. Base....3.0 x 1.6 x 1.0. .4.6
 Weight complete 1600 lbs.; no B. B. 790 lbs.

C.....	\$112.00
D.....	101.00
F.....	96.50
G.....	94.00
H.....	92.00
I.....	89.50
K.....	85.50
L.....	82.00

If B. B. is omitted deduct \$15.75

No. 5148

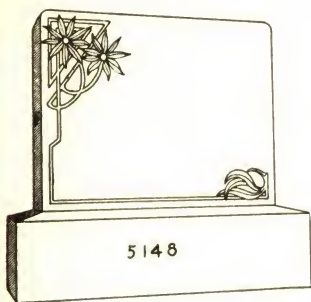

Die.....2.6 x 0.10 x 2.0 .4.2
 B. Base.....3.0 x 1.4 x 1.0 .4.0
 Weight complete 1450 lbs.; no B. B. 750 lbs.

C.....	\$79.50
D.....	70.00
F.....	66.00
G.....	64.00
H.....	62.00
I.....	59.50
K.....	56.50
L.....	53.50

If B. B. is omitted deduct \$14.00
 Face only polished; balance sand finished

No. 5148¹/₄

Die.....2.6 x 0.8 x 2.0 .3.4
 B. Base.....3.0 x 1.2 x 1.0 .3.6
 Weight complete 1225 lbs.; no B. B. 595 lbs.

C.....	\$65.50
D.....	58.00
F.....	55.00
G.....	53.00
H.....	51.50
I.....	49.75
K.....	47.25
L.....	44.75

If B. B. is omitted deduct \$12.25
 Face only polished; balance sand finished

No. 5148¹/₂

Die.....2.6 x 0.6 x 2.0 .2.6
 B. Base.....3.0 x 1.0 x 0.10 .2.6
 Weight complete 900 lbs.; no B. B. 450 lbs.

C.....	\$51.50
D.....	45.75
F.....	43.25
G.....	42.00
H.....	40.75
I.....	39.50
K.....	37.50
L.....	35.75

If B. B. is omitted deduct \$9.00
 Face only polished; balance sand finished

No. 5149

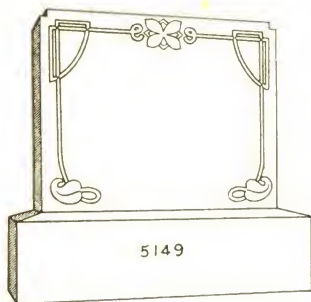

Die.....2.6 x 0.10 x 2.0 .4.2
 B. Base.....3.0 x 1.4 x 1.0 .4.0
 Weight complete 1450 lbs.; no B. B. 750 lbs.

C.....	\$80.50
D.....	71.00
F.....	67.00
G.....	65.00
H.....	63.00
I.....	60.50
K.....	57.50
L.....	54.50

If B. B. is omitted deduct \$14.00
 Face only polished; balance sand finished

No. 5149¹/₄

Die.....2.6 x 0.8 x 2.0 .3.4
 B. Base.....3.0 x 1.2 x 0.10 .2.11
 Weight complete 1125 lbs.; no B. B. 595 lbs.

C.....	\$65.00
D.....	57.50
F.....	54.50
G.....	52.50
H.....	51.00
I.....	49.50
K.....	46.75
L.....	44.25

If B. B. is omitted deduct \$10.50
 Face only polished; balance sand finished

No. 5149¹/₂

Die.....2.6 x 0.6 x 2.0 .2.6
 B. Base.....3.0 x 1.0 x 0.10 .2.6
 Weight complete 900 lbs.; no B. B. 450 lbs.

C.....	\$53.00
D.....	47.00
F.....	44.50
G.....	43.25
H.....	42.00
I.....	40.75
K.....	38.75
L.....	37.00

If B. B. is omitted deduct \$9.00
 Face only polished; balance sand finished

No. 5150

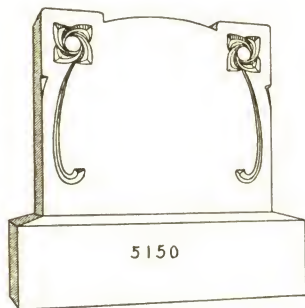

Die.....2.6 x 0.10 x 2.0 . 4.2
 B. Base.....3.0 x 1.4 x 1.0 . 4.0
 Weight complete 1450 lbs.; no B. B. 750 lbs.

C.....	\$79.50
D.....	70.00
F.....	66.00
G.....	64.00
H.....	62.00
I.....	59.50
K.....	57.50
L.....	53.50

If B. B. is omitted deduct \$14.00
 Face only polished; balance sand finished

No. 5150¹/₄

Die.....2.6 x 0.8 x 2.0 . 3.4
 B. Base.....3.0 x 1.2 x 0.10 . 2.11
 Weight complete 1125 lbs.; no B. B. 595 lbs.

C.....	\$64.00
D.....	56.50
F.....	53.50
G.....	51.50
H.....	50.00
I.....	48.25
K.....	45.75
L.....	43.25

If B. B. is omitted deduct \$10.50
 Face only polished; balance sand finished

No. 5150¹/₂

Die.....2.6 x 0.6 x 2.0 . 2.6
 B. Base.....3.0 x 1.0 x 0.10 . 2.6
 Weight complete 900 lbs.; no B. B. 450 lbs.

C.....	\$51.50
D.....	45.75
F.....	43.25
G.....	42.00
H.....	40.75
I.....	39.50
K.....	37.50
L.....	35.75

If B. B. is omitted deduct \$9.00
 Face only polished; balance sand finished

No. 5152

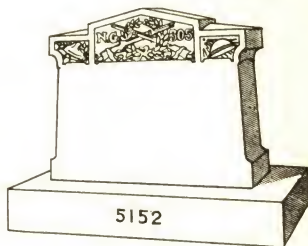

Die.....3.6 x 1.0 x 3.2 . 11.1
 B. Base.....4.4 x 1.10 x 1.0 . 7.11
 Weight complete 3200 lbs.; no B. B. 1800 lbs.

C.....	\$302.00
D.....	278.00
F.....	266.00
G.....	261.00
H.....	255.00
I.....	250.00
K.....	242.00
L.....	233.00

If B. B. is omitted deduct \$27.70
 All polished. If cut parts sand finished deduct \$5.00.

No. 5152¹/₄

Die.....3.6 x 0.10 x 3.2 . 9.3
 B. Base.....4.4 x 1.8 x 1.0 . 7.3
 Weight complete 2800 lbs.; no B. B. 1500 lbs.

C.....	\$274.00
D.....	254.00
F.....	244.00
G.....	240.00
H.....	235.00
I.....	231.00
K.....	224.00
L.....	217.00

If B. B. is omitted deduct \$25.40
 All polished. If cut parts sand finished deduct \$4.50.

No. 5152¹/₂

Die.....3.6 x 0.8 x 3.2 . 7.5
 B. Base.....4.2 x 1.4 x 1.0 . 5.7
 Weight complete 2200 lbs.; no B. B. 1225 lbs.

C.....	\$241.00
D.....	225.00
F.....	217.00
G.....	214.00
H.....	210.00
I.....	206.00
K.....	201.00
L.....	195.00

If B. B. is omitted deduct \$19.55
 All polished. If cut parts sand finished deduct \$4.00.

No. 5154

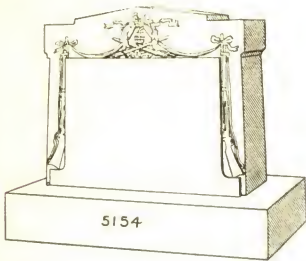

Die.....3.8 x 1.2 x 3.4..14.3
 B. Base.....4.6 x 2.0 x 1.2..10.6
 Weight complete 4000 lbs.; no B.B.2100 lbs.

D.....	\$338.00
F.....	324.00
G.....	317.00
H.....	310.00
I.....	302.00
K.....	292.00
L.....	281.00

If B. B. is omitted deduct \$36.75
 Polished. If sand finished deduct \$16.50

No. 5154¹/₄

Die.....3.8 x 1.0 x 3.4..12.3
 B. Base.....4.6 x 1.10 x 1.2..9.8
 Weight complete 3600 lbs.; no B.B.1850 lbs.

D.....	\$314.00
F.....	302.00
G.....	296.00
H.....	290.00
I.....	284.00
K.....	274.00
L.....	265.00

If B. B. is omitted deduct \$33.85
 Polished. If sand finished deduct \$15.50

No. 5154¹/₂

Die.....3.4 x 0.10 x 3.0..8.4
 B. Base.....4.0 x 1.6 x 1.0..6.0
 Weight complete 2300 lbs.; no B.B.1225 lbs.

D.....	\$239.00
F.....	231.00
G.....	227.00
H.....	223.00
I.....	218.00
K.....	212.00
L.....	206.00

If B. B. is omitted deduct \$21.00
 Polished. If sand finished deduct \$14.25

No. 5154³/₄

Die.....3.4 x 0.8 x 3.0..6.8
 B. Base.....4.0 x 1.4 x 1.0..5.4
 Weight complete 2050 lbs.; no B.B.1150 lbs.

D.....	\$217.00
F.....	211.00
G.....	207.00
H.....	204.00
I.....	201.00
K.....	196.00
L.....	191.00

If B. B. is omitted deduct \$18.65
 Polished. If sand finished deduct \$13.25

No. 5156

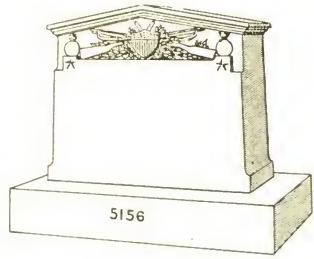

Die.....3.10 x 1.2 x 3.6..15.8
 B. Base.....4.8 x 2.0 x 1.2..10.11
 Weight complete 4300 lbs.; no B.B.2500 lbs.

D.....	\$365.00
F.....	349.00
G.....	341.00
H.....	334.00
I.....	326.00
K.....	314.00
L.....	302.00

If B. B. is omitted deduct \$38.20
 Polished. If sand finished deduct \$16.50

No. 5156¹/₄

Die.....3.10 x 1.0 x 3.6..13.5
 B. Base.....4.8 x 1.10 x 1.2..10.0
 Weight complete 3800 lbs.; no B.B.2100 lbs.

D.....	\$334.00
F.....	320.00
G.....	314.00
H.....	307.00
I.....	300.00
K.....	290.00
L.....	280.00

If B. B. is omitted deduct \$35.00
 Polished. If sand finished deduct \$15.50

No. 5156¹/₂

Die.....3.6 x 0.10 x 3.2..9.3
 B. Base.....4.2 x 1.6 x 1.0..6.3
 Weight complete 2500 lbs.; no B.B.1450 lbs.

D.....	\$258.00
F.....	248.00
G.....	244.00
H.....	239.00
I.....	235.00
K.....	228.00
L.....	221.00

If B. B. is omitted deduct \$21.90
 Polished. If sand finished deduct \$14.25

No. 5156³/₄

Die.....3.6 x 0.8 x 3.2..7.5
 B. Base.....4.2 x 1.4 x 1.0..5.7
 Weight complete 2150 lbs.; no B.B.1250 lbs.

D.....	\$225.00
F.....	217.00
G.....	214.00
H.....	210.00
I.....	206.00
K.....	201.00
L.....	195.00

If B. B. is omitted deduct \$19.55
 Polished. If sand finished deduct \$13.25

No. 5157

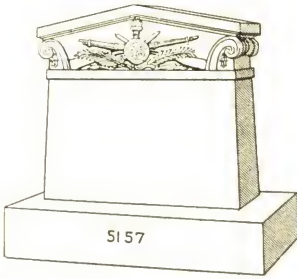

Die.....	3.8 x 1.2 x 3.8..	15.8
B. Base.....	4.6 x 2.0 x 1.2..	10.6
Weight complete 4300 lbs.; no B.B.2500 lbs.		
D.....		\$375.00
F.....		359.00
G.....		351.00
H.....		344.00
I.....		336.00
K.....		324.00
L.....		312.00

If B. B. is omitted deduct \$36.75
Polished. If sand finished deduct \$16.50

No. 5157 1/4

Die.....	3.8 x 1.0 x 3.8..	13.5
B. Base.....	4.6 x 1.10 x 1.2..	9.8
Weight complete 3800 lbs.; no B.B.2100 lbs.		
D.....		\$345.00
F.....		331.00
G.....		325.00
H.....		318.00
I.....		311.00
K.....		301.00
L.....		291.00

If B. B. is omitted deduct \$33.85
Polished. If sand finished deduct \$15.50

No. 5157 1/2

Die.....	3.4 x 0.10 x 3.4..	9.3
B. Base.....	4.0 x 1.6 x 1.0..	6.0
Weight complete 2500 lbs.; no B.B.1450 lbs.		
D.....		\$259.00
F.....		249.00
G.....		245.00
H.....		240.00
I.....		236.00
K.....		229.00
L.....		222.00

If B. B. is omitted deduct \$21.00
Polished. If sand finished deduct \$14.25

No. 5157 3/4

Die.....	3.4 x 0.8 x 3.4..	7.5
B. Base.....	4.0 x 1.4 x 1.0..	5.4
Weight complete 2150 lbs.; no B.B.1250 lbs.		
D.....		\$232.00
F.....		224.00
G.....		221.00
H.....		217.00
I.....		213.00
K.....		208.00
L.....		202.00

If B. B. is omitted deduct \$18.65
Polished. If sand finished deduct \$13.25

No. 5158

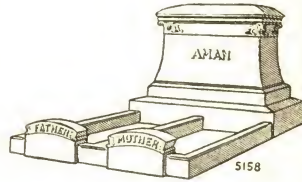

Cap.....	4.7 x 2.1 x 1.3..	11.11
Die.....	4.6 x 2.0 x 2.0..	18.0
Base.....	5.0 x 2.6 x 0.8..	8.4
B. Base.....	6.2 x 3.8 x 1.2..	26.5
2 Markers.....	1.8 x 0.8 x 1.2..	2.8
3 Sides.....	6.0 x 0.6 x 0.8..	6.0
2 Ends.....	0.9 x 0.6 x 0.8..	0.6
1 End.....	1.1 x 0.6 x 0.8..	0.4

Weight complete 12000 lbs.

C.....		\$1140.00
D.....		1047.00
F.....		1007.00
G.....		986.00
H.....		966.00
I.....		945.00
K.....		914.00
L.....		884.00

B. Base, sides and ends in "L" grade stock grit finished, balance of job polished.
If entire job grit finished deduct \$20.00.

No. 5158 1/4

Cap.....	3.11 x 1.9 x 1.1..	7.5
Die.....	3.10 x 1.8 x 1.10..	11.9
Base.....	4.4 x 2.2 x 0.8..	6.3
B. Base.....	5.4 x 3.2 x 1.0..	16.11
2 Markers.....	1.4 x 0.8 x 1.0..	1.10
3 Sides.....	6.0 x 0.5 x 0.7..	4.6
2 Ends.....	0.8 x 0.5 x 0.7..	0.4
1 End.....	1.1 x 0.5 x 0.7..	0.3

Weight complete 8300 lbs.

C.....		\$850.00
D.....		789.00
F.....		761.00
G.....		748.00
H.....		734.00
I.....		721.00
K.....		700.00
L.....		680.00

B. Base, sides and ends in "L" grade stock, grit finished, balance of job polished.
If entire job grit finished deduct \$12.00.

No. 5160

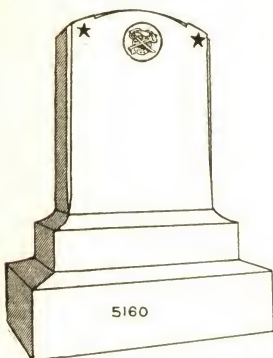

Die.....2. 4x0.10x3.0. .5.10
 Base.....2.10x1. 4x0.8. .2. 6
 B. Base...3. 6x2. 0x1.0. .7. 0
 Weight complete 2600 lbs.; no B.B.1340 lbs.

- C.....\$174.00
- D.....155.00
- F.....147.00
- G.....143.00
- H.....139.00
- I.....134.00
- K.....128.00
- L.....122.00

If B. B. is omitted deduct \$24.50

No. 5160¹/₄

Die.....2.0x0. 8x2.8. .3. 7
 Base.....2.6x1. 2x0.8. .1.11
 B. Base...3.2x1.10x1.0. .5.10
 Weight complete 1950 lbs.; no B. B. 900 lbs.

- C.....\$128.00
- D.....116.00
- F.....110.00
- G.....108.00
- H.....105.00
- I.....102.00
- K.....98.00
- L.....94.00

If B. B. is omitted deduct \$20.40

No. 5160¹/₂

Die.....1.8x0. 6x2. 4. .1.11
 Base.....2.0x0.10x0. 6. .0.10
 B. Base...2.6x1. 4x0.10. .2. 9
 Weight complete 950 lbs.; no B. B. 455 lbs.

- C.....\$77.50
- D.....71.50
- F.....68.50
- G.....67.50
- H.....66.00
- I.....64.50
- K.....62.50
- L.....60.50

If B. B. is omitted deduct \$9.90

No. 5163

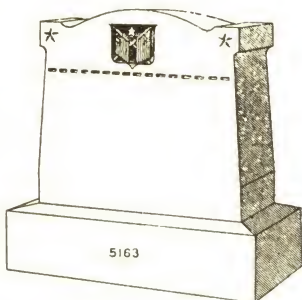

Die.....2.10x1.0x2.8. .7.7
 B. Base.....3. 4x1.6x1.0. .5.0
 Weight complete 2100 lbs.; no B.B.1200 lbs.

- C.....\$157.00
- D.....140.00
- F.....132.00
- G.....128.00
- H.....125.00
- I.....121.00
- K.....115.00
- L.....109.00

If B. B. is omitted deduct \$17.50

No. 5163¹/₄

Die.....2.10x0.10x2.8. .6.4
 B. Base.....3. 4x1.2x1.0. .4.5
 Weight complete 1850 lbs.; no B.B.1055 lbs.

- C.....\$135.00
- D.....121.00
- F.....115.00
- G.....112.00
- H.....109.00
- I.....105.00
- K.....101.00
- L.....96.00

If B. B. is omitted deduct \$15.45

No. 5163¹/₂

Die.....2.10x0.8x2.8. .5. 0
 B. Base.....3. 4x1.2x1.0. .3.11
 Weight complete 1550 lbs.; no B. B. 845 lbs.

- C.....\$114.00
- D.....103.00
- F.....97.50
- G.....95.00
- H.....92.50
- I.....90.00
- K.....86.50
- L.....82.50

If B. B. is omitted deduct \$13.70

No. 5166

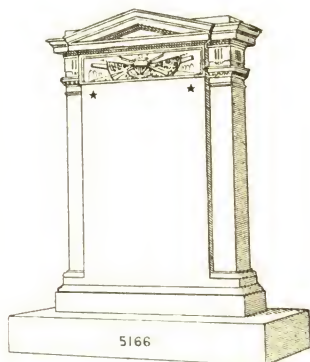

Cap...5. 0 x 1. 6½ x 1. 0.. 7.11
 Plinth. 4. 5 x 0.11½ x 0.10.. 3. 8
 Die....4. 5 x 0.11 x 5. 4..21. 8
 Base...4.10 x 1. 4 x 0. 9.. 4.10
 B. Base.6. 2 x 2. 8 x 1. 0..16. 5

Weight complete 9600 lbs.; no B.B.6700 lbs.

C.....	\$1068.00
D.....	982.00
F.....	944.00
G.....	925.00
H.....	906.00
I.....	887.00
K.....	858.00
L.....	830.00

If B. B. is omitted deduct \$57.45
 All polished. If grit finished deduct \$35.00.

No. 5170



Die.....3.6 x 1.0 x 2.6..8.9
 B. Base.....4.6 x 1.8 x 1.0..7.6

Weight complete 2700 lbs.; no B.B.1350 lbs.

C.....	\$220.00
D.....	200.00
F.....	192.00
G.....	187.00
H.....	183.00
I.....	179.00
K.....	172.00
L.....	165.00

If B. B. is omitted deduct \$26.25
 Face of panel polished; balance sand finished.

No. 5170¼

Die.....3.6 x 0.10 x 2.6..7.4
 B. Base.....4.6 x 1. 6 x 1.0..6.9

Weight complete 2400 lbs.; no B.B.1200 lbs.

C.....	\$196.00
D.....	180.00
F.....	172.00
G.....	169.00
H.....	165.00
I.....	161.00
K.....	156.00
L.....	150.00

If B. B. is omitted deduct \$23.65
 Face of panel polished; balance sand finished.

No. 5170½

Die.....3.6 x 0.8 x 2.6..5.10
 B. Base.....4.6 x 1.4 x 1.0..6. 0

Weight complete 2000 lbs.; no B. B. 920 lbs.

C.....	\$171.00
D.....	158.00
F.....	152.00
G.....	149.00
H.....	146.00
I.....	143.00
K.....	139.00
L.....	135.00

If B. B. is omitted deduct \$21.00
 Face of panel polished; balance sand finished.

No. 5170½

See previous column

No. 5171

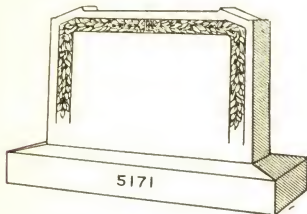

Die.....3.6 x 0.10 x 2.6..7.4
 B. Ba...(S.S.)4.2 x 1.6 x 1.0..6.3
 Weight complete 2600 lbs.

C.....	\$243.00
D.....	227.00
F.....	219.00
G.....	216.00
H.....	212.00
I.....	208.00
K.....	203.00
L.....	197.00

M. M. finish

No. 5172

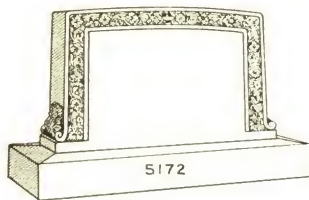

Die.....4.0 x 1.0 x 2.4..9.4
 B. Ba...(S.S.)5.0 x 1.8 x 1.0..8.4
 Weight complete 3000 lbs.

C.....	\$347.00
D.....	326.00
F.....	316.00
G.....	312.00
H.....	307.00
I.....	302.00
K.....	295.00
L.....	288.00

M. M. finish

No. 5171¹/₄

Die.....3.0 x 0.8 x 2.2..4.4
 B. Ba...(S.S.)3.8 x 1.4 x 1.0..4.11
 Weight complete 1600 lbs.

C.....	\$178.00
D.....	168.00
F.....	164.00
G.....	162.00
H.....	160.00
I.....	157.00
K.....	154.00
L.....	151.00

M. M. finish

No. 5172¹/₄

Die.....4.0 x 0.10 x 2.4..7.9
 B. Ba...(S.S.)5.0 x 1.6 x 1.0..7.6
 Weight complete 2600 lbs.

C.....	\$316.00
D.....	299.00
F.....	291.00
G.....	287.00
H.....	283.00
I.....	280.00
K.....	274.00
L.....	268.00

M. M. finish

No. 5171¹/₂

Die.....2.8 x 0.6 x 2.0..2.8
 B. Ba...(S.S.)3.2 x 1.0 x 0.10..2.8
 Weight complete 925 lbs.

C.....	\$126.00
D.....	120.00
F.....	118.00
G.....	116.00
H.....	115.00
I.....	114.00
K.....	112.00
L.....	110.00

M. M. finish

No. 5172¹/₂

Die.....4.0 x 0.8 x 2.4..6.3
 B. Ba...(S.S.)5.0 x 1.2 x 0.10..4.10
 Weight complete 1900 lbs.

C.....	\$278.00
D.....	264.00
F.....	258.00
G.....	255.00
H.....	252.00
I.....	249.00
K.....	244.00
L.....	239.00

M. M. finish

No. 5174

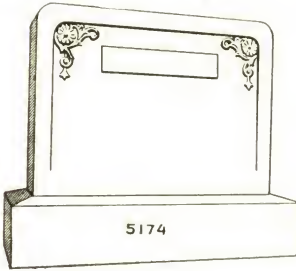

Die.....4. 0 x 1.0 x 2.10..11.4
 B. Base...4.10 x 1.8 x 1. 0. . 8.1
 Weight complete 3400 lbs.; no B. B. 2050 lbs.

C.....	\$237.00
D.....	212.00
F.....	200.00
G.....	195.00
H.....	189.00
I.....	183.00
K.....	175.00
L.....	166.00

If B. B. is omitted deduct \$28.30
 Grit finish

No. 5177

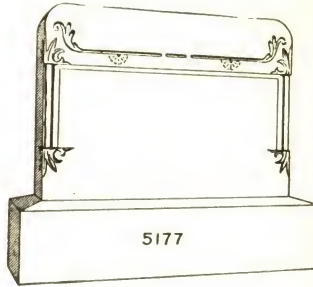

Die.....3.0 x 0.8 x 2. 2. .4.4
 B. Base.....3.6 x 1.2 x 0.10. .3.5
 Weight complete 1400 lbs.; no B. B. 785 lbs.

C.....	\$84.00
D.....	74.00
F.....	70.00
G.....	67.50
H.....	65.50
I.....	63.50
K.....	60.00
L.....	57.00

If B. B. is omitted deduct \$11.95

No. 5174¹/₄

Die.....4. 0 x 0.10 x 2.10..9.5
 B. Base...4.10 x 1. 6 x 1. 0. .7.3
 Weight complete 2950 lbs.; no B.B.1650 lbs.

C.....	\$210.00
D.....	189.00
F.....	179.00
G.....	175.00
H.....	170.00
I.....	165.00
K.....	158.00
L.....	151.00

If B. B. is omitted deduct \$25.40
 Grit finish

No. 5174¹/₂

Die.....4.0 x 0.8 x 2.10..7.7
 B. Base.....4.8 x 1.2 x 0.10. .4.6
 Weight complete 2150 lbs.; no B.B.1340 lbs.

C.....	\$175.00
D.....	158.00
F.....	150.00
G.....	146.00
H.....	143.00
I.....	139.00
K.....	133.00
L.....	127.00

If B. B. is omitted deduct \$15.75
 Grit finish

No. 5177¹/₄

Die.....3.0 x 0.6 x 2. 2. .3. 3
 B. Base.....3.6 x 1.0 x 0.10. .2.11
 Weight complete 1100 lbs.; no B. B. 575 lbs.

C.....	\$68.00
D.....	60.50
F.....	57.50
G.....	56.00
H.....	54.00
I.....	52.50
K.....	50.00
L.....	47.50

If B. B. is omitted deduct \$10.50

No. 5178

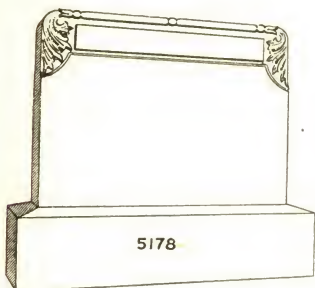

Die.....3.0 x 0.8 x 2. 2. .4.4
 B. Base.....3.6 x 1.2 x 0.10. .3.5
 Weight complete 1400 lbs.; no B. B. 785 lbs.

- C.....\$92.00
- D.....82.00
- F.....78.00
- G.....75.50
- H.....73.50
- I.....71.50
- K.....68.00
- L.....65.00

If B. B. is omitted deduct \$11.95

No. 5179

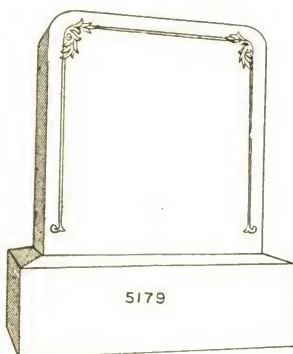

Die.....2.6 x 1.0 x 2.8. .6.8
 B. Base.....3.2 x 1.8 x 1.2. .6.2
 Weight complete 2300 lbs.; no B. B. 1200 lbs.

- C.....\$122.00
- D.....107.00
- F.....101.00
- G.....97.50
- H.....94.00
- I.....90.50
- K.....85.50
- L.....80.50

If B. B. is omitted deduct \$21.60

No. 5179¹/₄

Die.....2. 4 x 0.10 x 2.6. .4.10
 B. Base....2.10 x 1. 4 x 1.0. .3. 9
 Weight complete 1500 lbs.; no B. B. 800 lbs.

- C.....\$88.50
- D.....77.50
- F.....72.50
- G.....70.50
- H.....68.00
- I.....65.50
- K.....61.50
- L.....58.00

If B. B. is omitted deduct \$13.15

No. 5178¹/₄

Die.....3.0 x 0.6 x 2. 2. .3. 3
 B. Base....3.6 x 1.0 x 0.10. .2.11
 Weight complete 1100 lbs.; no B. B. 575 lbs.

- C.....\$75.00
- D.....67.50
- F.....64.50
- G.....63.00
- H.....61.00
- I.....59.50
- K.....57.00
- L.....54.50

If B. B. is omitted deduct \$10.50

No. 5179¹/₂

Die.....2.2 x 0.8 x 2.4. .3.4
 B. Base....2.8 x 1.2 x 1.0. .3.1
 Weight complete 1125 lbs.; no B. B. 570 lbs.

- C.....\$65.00
- D.....56.50
- F.....54.00
- G.....52.00
- H.....50.50
- I.....48.75
- K.....46.25
- L.....43.75

If B. B. is omitted deduct \$10.80

No. 5182

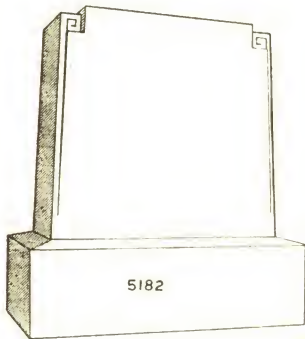

Die.....2.8 x 1.0 x 2.6 .6.8
 B. Ba. (S.S.) . . .3.4 x 1.6 x 1.0 .5.0

Weight complete 2100 lbs.

D.....\$118.00
 F.....112.00
 G.....107.00
 H.....105.00
 I.....101.00
 K.....96.50
 L.....91.50

"M. M." finish

No. 5183

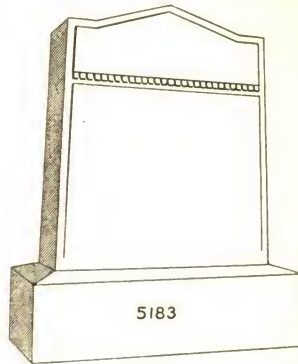

Die.....2.8 x 1.0 x 3.0 .8.0
 B. Ba. (S.S.) . . .3.6 x 1.8 x 1.0 .5.10

Weight complete 2400 lbs.

D.....\$149.00
 F.....141.00
 G.....137.00
 H.....133.00
 I.....129.00
 K.....123.00
 L.....117.00

"M. M." finish

No. 5182¹/₄

Die.....2.6 x 0.10 x 2.4 .4.10
 B. Ba. (S.S.) .3.0 x 1.3 x 0.10 .3.2

Weight complete 1440 lbs.

D.....\$88.50
 F.....83.50
 G.....81.00
 H.....79.00
 I.....76.50
 K.....72.50
 L.....69.00

"M. M." finish

No. 5183¹/₄

Die.....2.6 x 0.10 x 2.10 .5.11
 B. Ba. (S.S.) .3.4 x 1.6 x 1.0 .5.0

Weight complete 1900 lbs.

D.....\$119.00
 F.....113.00
 G.....110.00
 H.....107.00
 I.....104.00
 K.....99.50
 L.....95.50

"M. M." finish

No. 5182¹/₂

Die.....2.4 x 0.8 x 2.2 .3.4
 B. Ba. (S.S.) .2.10 x 1.0 x 0.10 .2.4

Weight complete 1020 lbs.

D.....\$66.00
 F.....63.00
 G.....61.00
 H.....59.50
 I.....58.00
 K.....55.00
 L.....53.00

"M. M." finish

No. 5183¹/₂

Die.....2.4 x 0.8 x 2.8 .4.2
 B. Ba. (S.S.) .3.0 x 1.2 x 0.10 .2.11

Weight complete 1225 lbs.

D.....\$87.00
 F.....83.00
 G.....81.00
 H.....79.00
 I.....76.50
 K.....73.50
 L.....70.50

"M. M." finish

No. 5184

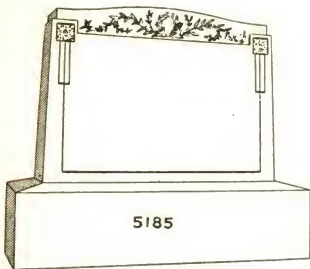

Die.....3.0 x 0.10 x 2.4 .5.10
 B.Ba. (S.S.) .3.8 x 1.4 x 1.0 .4.11

Weight complete 1700 lbs.

C.....	\$172.00
D.....	159.00
F.....	153.00
G.....	150.00
H.....	147.00
I.....	144.00
K.....	140.00
L.....	136.00

"M. M." finish

No. 5185

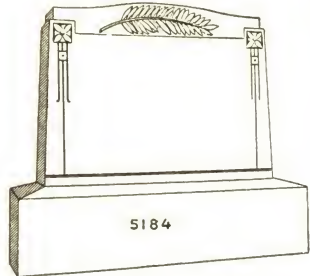

Die.....3.0 x 0.10 x 2.4 .5.10
 B.Ba. (S.S.) .3.8 x 1.4 x 1.0 .4.11

Weight complete 1850 lbs.

C.....	\$168.00
D.....	155.00
F.....	149.00
G.....	146.00
H.....	143.00
I.....	140.00
K.....	136.00
L.....	132.00

"M. M." finish

No. 5184¹/₄

Die.....3.0 x 0.8 x 2.4 .4.8
 B. Ba. (S.S.) .3.8 x 1.2 x 1.0 .4.3

Weight complete 1500 lbs.

C.....	\$149.00
D.....	138.00
F.....	134.00
G.....	131.00
H.....	129.00
I.....	127.00
K.....	123.00
L.....	120.00

"M. M." finish

No. 5185¹/₄

Die.....3.0 x 0.8 x 2.4 .4.8
 B. Ba. (S.S.) .3.8 x 1.2 x 1.0 .4.3

Weight complete 1575 lbs.

C.....	\$148.00
D.....	137.00
F.....	133.00
G.....	130.00
H.....	128.00
I.....	126.00
K.....	122.00
L.....	119.00

"M. M." finish

No. 5184¹/₂

Die.....3.0 x 0.6 x 2.4 .3.6
 B.Ba. (S.S.) .3.6 x 0.10 x 0.10 .2.5

Weight complete 1000 lbs.

C.....	\$121.00
D.....	113.00
F.....	109.00
G.....	108.00
H.....	106.00
I.....	104.00
K.....	102.00
L.....	99.00

"M. M." finish

No. 5185¹/₂

Die.....3.0 x 0.6 x 2.4 .3.6
 B. Ba. (S.S.) .3.8 x 1.0 x 0.10 .3.1

Weight complete 1150 lbs.

C.....	\$124.00
D.....	116.00
F.....	113.00
G.....	111.00
H.....	109.00
I.....	107.00
K.....	105.00
L.....	102.00

"M. M." finish

No. 5186

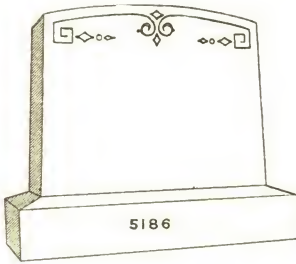

Die.....2.6 x 0.10 x 2. 0. 4.2
 B.Ba. (S.S.) .3.0 x 1. 4 x 0.10. .3.4
 Weight complete 1300 lbs.

D.....	\$78.50
F.....	74.50
G.....	72.50
H.....	70.50
I.....	68.00
K.....	65.00
L.....	62.00

"M. M." finish

No. 5186¹/₄

Die.....2.6 x 0.8 x 2. 0. 3. 4
 B.Ba. (S.S.) .3.0 x 1.2 x 0.10. .2.11
 Weight complete 1025 lbs.

D.....	\$65.00
F.....	62.00
G.....	60.00
H.....	58.50
I.....	57.00
K.....	54.50
L.....	52.00

"M. M." finish

No. 5186¹/₂

Die....2.6 x 0.6 x 2. 0. 2.6
 B. Ba. (S.S.) 3. .0 x 1.0 x 0.10. .2.6
 Weight complete 875 lbs.

D.....	\$53.00
F.....	50.00
G.....	49.00
H.....	47.75
I.....	46.50
K.....	44.50
L.....	42.75

"M. M." finish

No. 5188

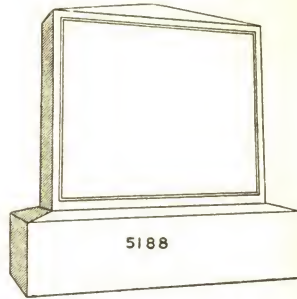

Die.....3.0 x 1.0 x 2.8. .8.0
 B. Ba. (S.S.)...3.8 x 1.8 x 1.0. .6.1
 Weight complete 2500 lbs.

D.....	150.00
F.....	142.00
G.....	138.00
H.....	134.00
I.....	130.00
K.....	124.00
L.....	118.00

"M. M." finish

No. 5188¹/₄

Die.....3.0 x 0.10 x 2.8. .6.8
 B. Ba. (S.S.)...3.8 x 1. 6 x 1.0. .5.6
 Weight complete 2175 lbs.

D.....	\$131.00
F.....	125.00
G.....	121.00
H.....	118.00
I.....	115.00
K.....	110.00
L.....	105.00

"M. M." finish

No. 5188¹/₂

Die.....2.6 x 0.8 x 2. 2. 3. 7
 B.Ba. (S.S.) .3.0 x 1.2 x 0.10. .2.11
 Weight complete 1150 lbs.

D.....	\$80.50
F.....	76.50
G.....	75.00
H.....	73.00
I.....	71.50
K.....	68.50
L.....	66.00

"M. M." finish

No. 5189

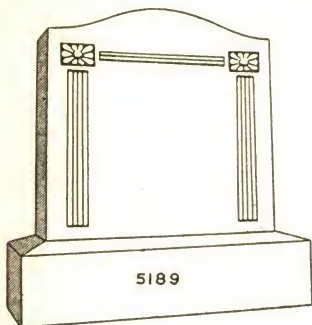

Die.....3. 0 x 1.0 x 2.10..8.6
 B.Ba. (S.S.) .3.10 x 1.8 x 1. 2..7.5
 Weight complete 2700 lbs.

D.....	\$169.00
F.....	161.00
G.....	157.00
H.....	152.00
I.....	148.00
K.....	142.00
L.....	135.00

"M. M." finish

No. 5190

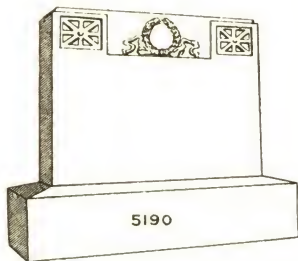

Die.....3.4 x 1.0 x 2.6..8. 4
 B. Ba. (S.S.) .4.2 x 1.8 x 1.0..6.11
 Weight complete 2600 lbs.

D.....	\$199.00
F.....	191.00
G.....	187.00
H.....	183.00
I.....	178.00
K.....	172.00
L.....	166.00

"M. M." finish

No. 5189¹/₄

Die.....3. 0 x 0.10 x 2.10..7.1
 B.Ba. (S.S.) .3.10 x 1. 6 x 1. 0..5.9
 Weight complete 2200 lbs.

D.....	\$146.00
F.....	138.00
G.....	135.00
H.....	131.00
I.....	128.00
K.....	123.00
L.....	117.00

"M. M." finish

No. 5190¹/₄

Die.....3.4 x 0.10 x 2.6..6.11
 B.Ba. (S.S.) .4.2 x 1. 6 x 1.0..6. 3
 Weight complete 2250 lbs.

D.....	\$178.00
F.....	172.00
G.....	168.00
H.....	165.00
I.....	161.00
K.....	156.00
L.....	151.00

"M. M." finish

No. 5189¹/₂

Die.....3.0 x 0.8 x 2.10..5.8
 B. Ba. (S.S.) .3.8 x 1.2 x 1. 0..4.3
 Weight complete 1675 lbs.

D.....	\$118.00
F.....	112.00
G.....	109.00
H.....	107.00
I.....	104.00
K.....	100.00
L.....	95.00

"M. M." finish

No. 5190¹/₂

Die.....3.4 x 0.8 x 2.6..5. 7
 B. Ba. (S.S.) .4.2 x 1.2 x 1.0..4.10
 Weight complete 1800 lbs.

D.....	\$155.00
F.....	149.00
G.....	146.00
H.....	144.00
I.....	141.00
K.....	137.00
L.....	132.00

"M. M." finish

No. 5192A

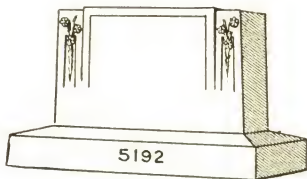

Die.....4.4 x 1.2 x 2.10..14.4
 B.Ba. (S.S.) .5.4 x 2.0 x 1. 2..12.5

Weight complete 4500 lbs.

- D.....\$357.00
- F.....343.00
- G.....336.00
- H.....329.00
- I.....321.00
- K.....311.00
- L.....300.00

"M. M." finish

No. 5192

Die.....4.0 x 1. 0 x 2.6..10.0
 B.Ba. (S.S.) .5.0 x 1.10 x 1.0.. 9.2

Weight complete 3300 lbs.

- D.....\$268.00
- F.....258.00
- G.....253.00
- H.....248.00
- I.....243.00
- K.....236.00
- L.....228.00

"M. M." finish

No. 5192¹/₄

Die.....4.0 x 0.10 x 2.6..8.4
 B. Ba. (S.S.) .5.0 x 1. 8 x 1.0..8.4

Weight complete 2900 lbs.

- D.....\$241.00
- F.....233.00
- G.....229.00
- H.....225.00
- I.....220.00
- K.....214.00
- L.....208.00

"M. M." finish

No. 5192¹/₂

Die.....4. 0 x 0.8 x 2. 6..6.8
 B.Ba. (S.S.) .4. 10 x 1.4 x 0.10..5.4

Weight complete 2100 lbs.

- D.....\$203.00
- F.....197.00
- G.....195.00
- H.....192.00
- I.....189.00
- K.....185.00
- L.....181.00

"M. M." finish

No. 5193A

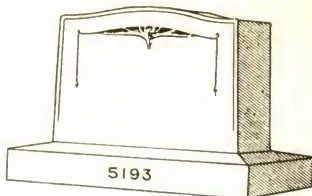

Die.....4.0 x 1.2 x 3.0..14.0
 B. Ba. (S.S.) .5.0 x 2.0 x 1.2..11.8

Weight complete 4500 lbs.

- D.....\$268.00
- F.....254.00
- G.....247.00
- H.....240.00
- I.....233.00
- K.....223.00
- L.....212.00

"M. M." finish

No. 5193

Die.....3.6 x 1. 0 x 2.8..9.4
 B. Ba. (S.S.) .4.6 x 1.10 x 1.0..8.3

Weight complete 3000 lbs.

- D.....\$190.00
- F.....180.00
- G.....176.00
- H.....171.00
- I.....166.00
- K.....159.00
- L.....152.00

"M. M." finish

No. 5193¹/₄

Die.....3.6 x 0.10 x 2.8..7.9
 B. Ba. (S.S.) .4.6 x 1. 8 x 1.0..7.6

Weight complete 2650 lbs.

- D.....\$164.00
- F.....156.00
- G.....152.00
- H.....149.00
- I.....145.00
- K.....139.00
- L.....133.00

"M. M." finish

No. 5193¹/₂

Die.....3.6 x 0.8 x 2.8..6.3
 B. Ba. (S.S.) .4.6 x 1.6 x 1.0..6.9

Weight complete 2200 lbs.

- D.....\$139.00
- F.....133.00
- G.....130.00
- H.....127.00
- I.....124.00
- K.....119.00
- L.....114.00

"M. M." finish

No. 5194A

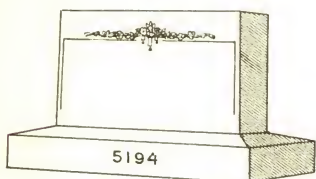

Die.....4.0 x 1.2 x 2.8...12.5
 B. Ba. (S.S.) .5.0 x 2.0 x 1.2...11.8

Weight complete 4300 lbs.

D.....	\$266.00
F.....	254.00
G.....	248.00
H.....	241.00
I.....	235.00
K.....	226.00
L.....	217.00

"M. M." finish

No. 5194

Die.....3.6 x 1.0 x 2.4...8.2
 B. Ba. (S.S.) .4.6 x 1.10 x 1.0...8.3

Weight complete 2900 lbs.

D.....	\$180.00
F.....	172.00
G.....	168.00
H.....	164.00
I.....	160.00
K.....	154.00
L.....	147.00

"M. M." finish

No. 5194¹/₄

Die.....3.6 x 0.10 x 2.4...6.10
 B. Ba. (S.S.) .4.6 x 1.8 x 1.0...7.6

Weight complete 2550 lbs.

D.....	\$157.00
F.....	151.00
G.....	147.00
H.....	144.00
I.....	140.00
K.....	135.00
L.....	130.00

"M. M." finish

No. 5194¹/₂

Die.....3.6 x 0.8 x 2.4...5.5
 B. Ba. (S.S.) .4.6 x 1.6 x 1.0...6.9

Weight complete 2150 lbs.

D.....	\$133.00
F.....	127.00
G.....	125.00
H.....	122.00
I.....	119.00
K.....	115.00
L.....	111.00

"M. M." finish

No. 5195A

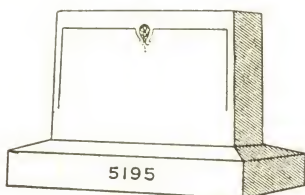

Die.....4.0 x 1.2 x 2.10...13.3
 B. Ba. (S.S.) .5.0 x 2.0 x 1.2...11.8

Weight complete 4500 lbs.

D.....	\$242.00
F.....	228.00
G.....	222.00
H.....	215.00
I.....	209.00
K.....	199.00
L.....	189.00

"M. M." finish

No. 5195

Die.....3.6 x 1.0 x 2.6...8.9
 B. Ba. (S.S.) .4.6 x 1.10 x 1.0...8.3

Weight complete 3000 lbs.

D.....	\$168.00
F.....	160.00
G.....	155.00
H.....	151.00
I.....	147.00
K.....	140.00
L.....	133.00

"M. M." finish

No. 5195¹/₄

Die.....3.6 x 0.10 x 2.6...7.4
 B. Ba. (S.S.) .4.6 x 1.8 x 1.0...7.6

Weight complete 2650 lbs.

D.....	\$147.00
F.....	139.00
G.....	136.00
H.....	132.00
I.....	128.00
K.....	123.00
L.....	117.00

"M. M." finish

No. 5195¹/₂

Die.....3.6 x 0.8 x 2.6...5.10
 B. Ba. (S.S.) .4.6 x 1.6 x 1.0...6.9

Weight complete 2225 lbs.

D.....	\$126.00
F.....	120.00
G.....	117.00
H.....	114.00
I.....	111.00
K.....	107.00
L.....	103.00

"M. M." finish

No. 5196A

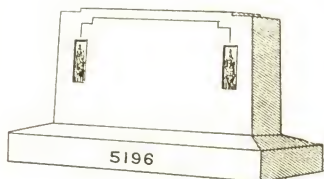

Die..... 4.0 x 1.2 x 3.0..14.0
 B. Ba. (S.S.).. 5.0 x 2.0 x 1.2..11.8

Weight complete 4500 lbs.

- D.....\$312.00
- F..... 298.00
- G..... 291.00
- H..... 284.00
- I..... 277.00
- K..... 267.00
- L..... 256.00

"M. M." finish

No. 5197

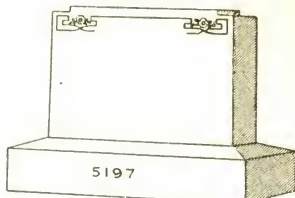

Die..... 3.8 x 1.0 x 2.8..9.9
 B. Ba. (S.S.).. 4.8 x 1.10 x 1.0..8.7

Weight complete 3150 lbs.

- D.....\$181.00
- F..... 171.00
- G..... 166.00
- H..... 161.00
- I..... 157.00
- K..... 149.00
- L..... 142.00

"M. M." finish

No. 5196

Die..... 3.6 x 1.0 x 2.8..9.4
 B. Ba. (S.S.).. 4.6 x 1.10 x 1.0..8.3

Weight complete 3100 lbs.

- D.....\$234.00
- F..... 224.00
- G..... 220.00
- H..... 215.00
- I..... 210.00
- K..... 203.00
- L..... 196.00

"M. M." finish

No. 5196¹/₄

Die..... 3.6 x 0.10 x 2.8..7.9
 B. Ba. (S.S.).. 4.6 x 1.8 x 1.0..7.6

Weight complete 2700 lbs.

- D.....\$210.00
- F..... 202.00
- G..... 198.00
- H..... 194.00
- I..... 191.00
- K..... 185.00
- L..... 179.00

"M. M." finish

No. 5196¹/₂

Die..... 3.6 x 0.8 x 2.8..6.3
 B. Ba. (S.S.).. 4.6 x 1.6 x 1.0..6.9

Weight complete 2300 lbs.

- D.....\$188.00
- F..... 182.00
- G..... 179.00
- H..... 176.00
- I..... 173.00
- K..... 168.00
- L..... 163.00

"M. M." finish

No. 5197¹/₂

Die..... 3.8 x 0.8 x 2.8..6.6
 B. Ba. (S.S.).. 4.8 x 1.4 x 1.0..6.3

Weight complete 2225 lbs.

- D.....\$129.00
- F..... 123.00
- G..... 120.00
- H..... 116.00
- I..... 113.00
- K..... 108.00
- L..... 103.00

"M. M." finish

No. 5198

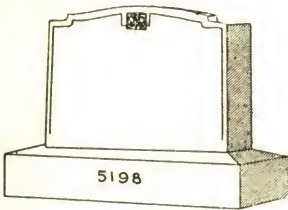

Die.....3.6 x 1.0 x 2.8 . . 9.4
 B. Ba. (S.S.)...4.4 x 1.8 x 1.0 . . 7.3

Weight complete 2850 lbs.

D.....	\$179.00
F.....	169.00
G.....	165.00
H.....	160.00
I.....	155.00
K.....	148.00
L.....	141.00

"M. M." finish

No. 5199

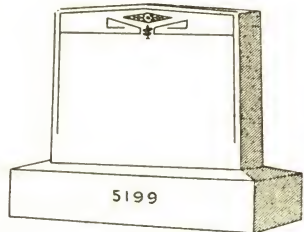

Die.....3.6 x 1.0 x 2.8 . . 9.4
 B. Ba. (S.S.)...4.4 x 1.8 x 1.0 . . 7.3

Weight complete 2850 lbs.

D.....	\$194.00
F.....	184.00
G.....	180.00
H.....	175.00
I.....	170.00
K.....	163.00
L.....	156.00

"M. M." finish

No. 5198¹/₄

Die.....3.6 x 0.10 x 2.8 . . 7.9
 B. Ba. (S.S.)...4.4 x 1.6 x 1.0 . . 6.6

Weight complete 2475 lbs.

D.....	\$155.00
F.....	147.00
G.....	143.00
H.....	139.00
I.....	136.00
K.....	130.00
L.....	124.00

"M. M." finish

No. 5199¹/₄

Die.....3.6 x 0.10 x 2.8 . . 7.9
 B. Ba. (S.S.)...4.4 x 1.6 x 1.0 . . 6.6

Weight complete 2475 lbs.

D.....	\$169.00
F.....	161.00
G.....	157.00
H.....	153.00
I.....	150.00
K.....	144.00
L.....	138.00

"M. M." finish

No. 5198¹/₂

Die.....3.6 x 0.8 x 2.8 . . 6.3
 B. Ba. (S.S.)...4.4 x 1.4 x 1.0 . . 5.9

Weight complete 2100 lbs.

D.....	\$133.00
F.....	127.00
G.....	124.00
H.....	121.00
I.....	118.00
K.....	113.00
L.....	108.00

"M. M." finish

No. 5199¹/₂

Die.....3.6 x 0.8 x 2.8 . . 6.3
 B. Ba. (S.S.)...4.4 x 1.4 x 1.0 . . 5.9

Weight complete 2100 lbs.

D.....	\$146.00
F.....	140.00
G.....	137.00
H.....	134.00
I.....	131.00
K.....	126.00
L.....	121.00

"M. M." finish

No. 5200

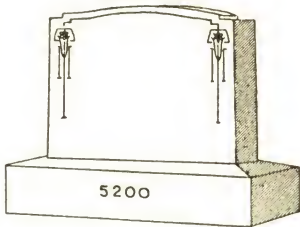

Die.....3.8 x 1. 0 x 2.10..10.5
 B.Ba. (S.S.) .4.8 x 1.10 x 1. 0.. 8.7
 Weight complete 3300 lbs.

- D.....\$193.00
- F..... 183.00
- G..... 178.00
- H..... 172.00
- I..... 167.00
- K..... 159.00
- L..... 152.00

"M. M." finish

No. 5200¹/₄

Die.....3.8 x 0.10 x 2.10..8.8
 B.Ba. (S.S.) .4.8 x 1. 8 x 1. 0..7.9
 Weight complete 2875 lbs.

- D.....\$167.00
- F..... 159.00
- G..... 154.00
- H..... 150.00
- I..... 146.00
- K..... 139.00
- L..... 133.00

"M. M." finish

No. 5200¹/₂

Die.....3.8 x 0.8 x 2.10..6.11
 B.Ba. (S.S.) .4.8 x 1.4 x 1. 0..6. 3
 Weight complete 2300 lbs.

- D.....\$137.00
- F..... 131.00
- G..... 127.00
- H..... 124.00
- I..... 120.00
- K..... 115.00
- L..... 110.00

"M. M." finish

No. 5201

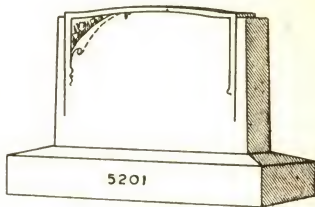

Die.....4.4 x 1.2 x 3.4..16.10
 B.Ba. (S.S.) .5.4 x 2.0 x 1.2..12. 5
 Weight complete 4100 lbs.

- D.....\$305.00
- F..... 289.00
- G..... 280.00
- H..... 272.00
- I..... 263.00
- K..... 251.00
- L..... 238.00

"M. M." finish

No. 5201¹/₄

Die.....4.0 x 1. 0 x 3.0..12.0
 B.Ba. (S.S.) .5.0 x 1.10 x 1.0.. 9.2
 Weight complete 3700 lbs.

- D.....\$236.00
- F..... 224.00
- G..... 218.00
- H..... 212.00
- I..... 206.00
- K..... 197.00
- L..... 188.00

"M. M." finish

No. 5201¹/₂

Die.....3.8 x 0.10 x 2.8..8.2
 B. Ba. (S.S.) .4.8 x 1. 8 x 1.0..7.9
 Weight complete 2775 lbs.

- D.....\$182.00
- F..... 174.00
- G..... 170.00
- H..... 166.00
- I..... 162.00
- K..... 156.00
- L..... 149.00

"M. M." finish

No. 5201³/₄

Die.....3.6 x 0.8 x 2.6..5.10
 B. Ba. (S.S.) .4.6 x 1.6 x 1.0..6. 9
 Weight complete 2200 lbs.

- D.....\$145.00
- F..... 139.00
- G..... 136.00
- H..... 133.00
- I..... 130.00
- K..... 126.00
- L..... 122.00

"M. M." finish

No. 5202

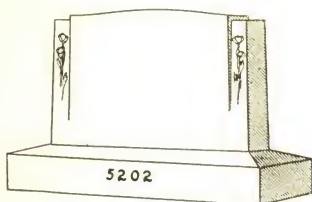

Die. 4.0 x 1.2 x 3.0 . 14.0
 B. Ba. (S.S.) . 5.0 x 2.0 x 1.2 . 11.8
 Weight complete 4500 lbs.

D. \$310.00
 F. 296.00
 G. 289.00
 H. 282.00
 I. 275.00
 K. 265.00
 L. 254.00

"M. M." finish

No. 5202¹/₄

Die. 3.6 x 1.0 x 2.8 . 9.4
 B. Ba. (S.S.) . 4.6 x 1.10 x 1.0 . 8.3
 Weight complete 3000 lbs.

D. \$235.00
 F. 225.00
 G. 221.00
 H. 216.00
 I. 211.00
 K. 204.00
 L. 197.00

"M. M." finish

No. 5202¹/₂

Die. 3.6 x 0.10 x 2.8 . 7.9
 B. Ba. (S.S.) . 4.6 x 1.8 x 1.0 . 7.6
 Weight complete 2650 lbs.

D. \$210.00
 F. 202.00
 G. 198.00
 H. 194.00
 I. 191.00
 K. 185.00
 L. 179.00

"M. M." finish

No. 5202³/₄

Die. 3.6 x 0.8 x 2.8 . 6.3
 B. Ba. (S.S.) . 4.6 x 1.6 x 1.0 . 6.9
 Weight complete 2275 lbs.

D. \$186.00
 F. 180.00
 G. 177.00
 H. 174.00
 I. 171.00
 K. 166.00
 L. 162.00

"M. M." finish

No. 5203

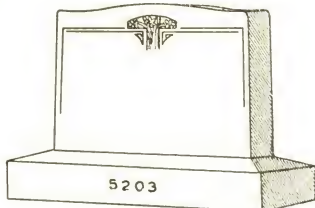

Die. 4.0 x 1.2 x 3.0 . 14.0
 B. Ba. (S.S.) . 5.0 x 2.0 x 1.2 . 11.8
 Weight complete 4500 lbs.

D. \$298.00
 F. 284.00
 G. 277.00
 H. 270.00
 I. 263.00
 K. 253.00
 L. 242.00

"M. M." finish

No. 5203¹/₄

Die. 3.6 x 1.0 x 2.8 . 9.4
 B. Ba. (S.S.) . 4.6 x 1.10 x 1.0 . 8.3
 Weight complete 3000 lbs.

D. \$227.00
 F. 217.00
 G. 213.00
 H. 208.00
 I. 203.00
 K. 196.00
 L. 189.00

"M. M." finish

No. 5203¹/₂

Die. 3.6 x 0.10 x 2.8 . 7.9
 B. Ba. (S.S.) . 4.6 x 1.8 x 1.0 . 7.6
 Weight complete 2650 lbs.

D. \$201.00
 F. 193.00
 G. 189.00
 H. 185.00
 I. 182.00
 K. 176.00
 L. 170.00

"M. M." finish

No. 5203³/₄

Die. 3.6 x 0.8 x 2.8 . 6.3
 B. Ba. (S.S.) . 4.6 x 1.6 x 1.0 . 6.9
 Weight complete 2275 lbs.

D. \$177.00
 F. 171.00
 G. 168.00
 H. 165.00
 I. 162.00
 K. 157.00
 L. 152.00

"M. M." finish

No. 5204

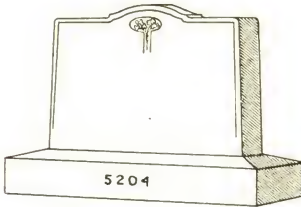

Die..... 4.0 x 1.2 x 2.10 .13.3
 B. Ba. (S.S.) .5.0 x 2.0 x 1. 2. .11.8
 Weight complete 4350 lbs.

D.....\$271.00
 F..... 257.00
 G..... 251.00
 H..... 244.00
 I..... 238.00
 K..... 228.00
 L..... 218.00

"M. M." finish

No. 5204¹/₄

Die..... 3.6 x 1. 0 x 2.6 .8.9
 B. Ba. (S.S.) .4.6 x 1.10 x 1.0 .8.3
 Weight complete 2900 lbs.

D.....\$192.00
 F..... 184.00
 G..... 179.00
 H..... 175.00
 I..... 171.00
 K..... 164.00
 L..... 157.00

"M. M." finish

No. 5204¹/₂

Die..... 3.6 x 0.10 x 2.6 .7.4
 B. Ba. (S.S.) .4.6 x 1. 8 x 1.0 .7.6
 Weight complete 2575 lbs.

D.....\$176.00
 F..... 168.00
 G..... 165.00
 H..... 161.00
 I..... 157.00
 K..... 152.00
 L..... 146.00

"M. M." finish

No. 5204³/₄

Die..... 3.6 x 0.8 x 2.6 .5.10
 B. Ba. (S.S.) .4.6 x 1.6 x 1.0 .6. 9
 Weight complete 2200 lbs.

D.....\$149.00
 F..... 143.00
 G..... 140.00
 H..... 137.00
 I..... 134.00
 K..... 130.00
 L..... 126.00

"M. M." finish

No. 5205

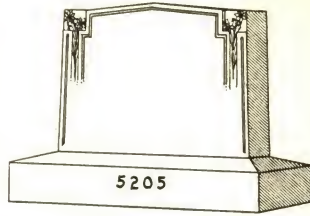

Die..... 4.0 x 1.2 x 3.0 .14.0
 B. Ba. (S.S.) .5.0 x 2.0 x 1.2 .11.8
 Weight complete 4500 lbs.

D.....\$314.00
 F..... 301.00
 G..... 295.00
 H..... 289.00
 I..... 283.00
 K..... 274.00
 L..... 265.00

"M. M." finish

No. 5205¹/₄

Die..... 3.6 x 1. 0 x 2.8 .9.4
 B. Ba. (S.S.) .4.6 x 1.10 x 1.0 .8.3
 Weight complete 3000 lbs.

D.....\$241.00
 F..... 231.00
 G..... 227.00
 H..... 222.00
 I..... 217.00
 K..... 210.00
 L..... 203.00

"M. M." finish

No. 5205¹/₂

Die..... 3.6 x 0.10 x 2.8 .7.9
 B. Ba. (S.S.) .4.6 x 1. 8 x 1.0 .7.6
 Weight complete 2650 lbs.

D.....\$216.00
 F..... 208.00
 G..... 204.00
 H..... 200.00
 I..... 197.00
 K..... 191.00
 L..... 185.00

"M. M." finish

No. 5205³/₄

Die..... 3.6 x 0.8 x 2.8 .6.3
 B. Ba. (S.S.) .4.6 x 1.6 x 1.0 .6.9
 Weight complete 2275 lbs.

D.....\$192.00
 F..... 186.00
 G..... 183.00
 H..... 180.00
 I..... 177.00
 K..... 172.00
 L..... 167.00

"M. M." finish

No. 5206

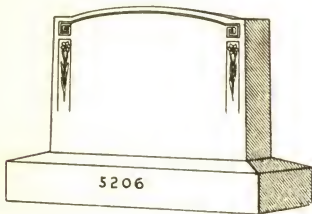

Die.....4.0 x 1.2 x 3.0..14.0
 B. Ba. (S.S.)..5.0 x 2.0 x 1.2..11.8
 Weight complete 4500 lbs.

D.....	\$291.00
F.....	277.00
G.....	270.00
H.....	263.00
I.....	256.00
K.....	246.00
L.....	235.00

"M. M." finish

No. 5206¹/₄

Die.....3.6 x 1.0 x 2.8..9.4
 B. Ba. (S.S.)..4.6 x 1.10 x 1.0..8.3
 Weight complete 3000 lbs.

D.....	\$222.00
F.....	212.00
G.....	208.00
H.....	203.00
I.....	198.00
K.....	191.00
L.....	184.00

"M. M." finish

No. 5206¹/₂

Die.....3.6 x 0.10 x 2.8..7.9
 B. Ba. (S.S.)..4.6 x 1.8 x 1.0..7.6
 Weight complete 2650 lbs.

D.....	\$195.00
F.....	187.00
G.....	183.00
H.....	179.00
I.....	176.00
K.....	170.00
L.....	164.00

"M. M." finish

No. 5206³/₄

Die.....3.6 x 0.8 x 2.8..6.3
 B. Ba. (S.S.)..4.6 x 1.6 x 1.0..6.9
 Weight complete 2275 lbs.

D.....	\$171.00
F.....	165.00
G.....	162.00
H.....	159.00
I.....	156.00
K.....	151.00
L.....	146.00

"M. M." finish

No. 5207

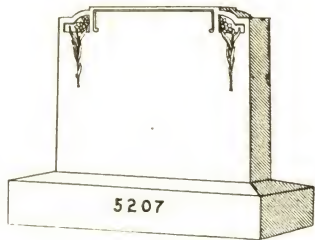

Die.....4.0 x 1.2 x 3.6..16.4
 B. Ba. (S.S.)..5.0 x 2.0 x 1.2..11.8
 Weight complete 4900 lbs.

D.....	\$332.00
F.....	316.00
G.....	308.00
H.....	300.00
I.....	291.00
K.....	279.00
L.....	267.00

"M. M." finish

No. 5207¹/₄

Die.....3.6 x 1.0 x 3.0..10.6
 B. Ba. (S.S.)..4.6 x 1.10 x 1.0..8.3
 Weight complete 3200 lbs.

D.....	\$245.00
F.....	235.00
G.....	230.00
H.....	224.00
I.....	219.00
K.....	211.00
L.....	203.00

"M. M." finish

No. 5207¹/₂

Die.....3.6 x 0.10 x 3.0..8.9
 B. Ba. (S.S.)..4.6 x 1.8 x 1.0..7.6
 Weight complete 2825 lbs.

D.....	\$219.00
F.....	211.00
G.....	206.00
H.....	202.00
I.....	198.00
K.....	191.00
L.....	184.00

"M. M." finish

No. 5207³/₄

Die.....3.6 x 0.8 x 3.0..7.0
 B. Ba. (S.S.)..4.6 x 1.6 x 1.0..6.9
 Weight complete 2400 lbs.

D.....	\$193.00
F.....	187.00
G.....	183.00
H.....	180.00
I.....	176.00
K.....	171.00
L.....	166.00

"M. M." finish

No. 5208

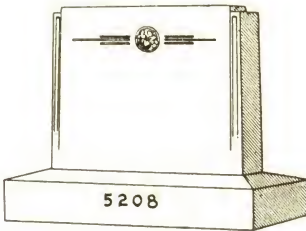

Die..... 4.0 x 1.2 x 3.4 .. 15.7
 B. Ba. (S.S.) .5.0 x 2.0 x 1.2 .. 11.8
 Weight complete 4775 lbs.

D.....	\$296.00
F.....	280.00
G.....	272.00
H.....	265.00
I.....	257.00
K.....	245.00
L.....	243.00

"M. M." finish

No. 5208¹/₄

Die..... 3.6 x 1. 0 x 2.10 .. 9.11
 B. Ba. (S.S.) .4.6 x 1.10 x 1. 0 .. 8. 3
 Weight complete 3100 lbs.

D.....	\$215.00
F.....	205.00
G.....	200.00
H.....	195.00
I.....	190.00
K.....	183.00
L.....	175.00

"M. M." finish

No. 5208¹/₂

Die..... 3.6 x 0.10 x 2.10 .. 8.3
 B. Ba. (S.S.) .4.6 x 1. 8 x 1. 0 .. 7.6
 Weight complete 2725 lbs.

D.....	\$189.00
F.....	181.00
G.....	177.00
H.....	173.00
I.....	169.00
K.....	162.00
L.....	156.00

"M. M." finish

No. 5208³/₄

Die..... 3.6 x 0.8 x 2.10 .. 6.7
 B. Ba. (S.S.) .4.6 x 1.6 x 1. 0 .. 6.9
 Weight complete 2325 lbs.

D.....	\$162.00
F.....	156.00
G.....	152.00
H.....	149.00
I.....	146.00
K.....	141.00
L.....	137.00

"M. M." finish

No. 5209

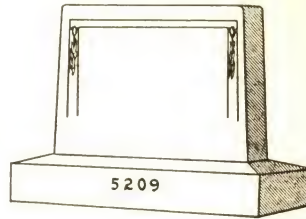

Die..... 4.0 x 1.2 x 2.10 .. 13.3
 B. Ba. (S.S.) .5.0 x 2.0 x 1.2 .. 11.8
 Weight complete 4350 lbs.

D.....	\$274.00
F.....	260.00
G.....	254.00
H.....	247.00
I.....	241.00
K.....	231.00
L.....	221.00

"M. M." finish

No. 5209¹/₄

Die..... 3.6 x 1. 0 x 2.6 .. 8.9
 B. Ba. (S.S.) .4.6 x 1.10 x 1.0 .. 8.3
 Weight complete 2900 lbs.

D.....	\$206.00
F.....	198.00
G.....	193.00
H.....	189.00
I.....	185.00
K.....	178.00
L.....	171.00

"M. M." finish

No. 5209¹/₂

Die..... 3.6 x 0.10 x 2.6 .. 7.4
 B. Ba. (S.S.) .4.6 x 1. 8 x 1.0 .. 7.6
 Weight complete 2575 lbs.

D.....	\$185.00
F.....	177.00
G.....	174.00
H.....	170.00
I.....	166.00
K.....	161.00
L.....	155.00

"M. M." finish

No. 5209³/₄

Die..... 3.6 x 0.8 x 2.6 .. 5.10
 B. Ba. (S.S.) .4.6 x 1.6 x 1.0 .. 6. 9
 Weight complete 2200 lbs.

D.....	\$162.00
F.....	156.00
G.....	153.00
H.....	150.00
I.....	147.00
K.....	143.00
L.....	139.00

"M. M." finish

No. 5210

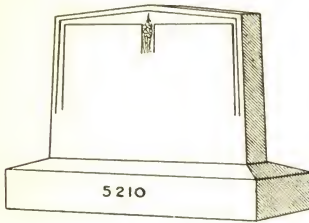

Die.....4.0 x 1.2 x 3.0..14.0
 B. Ba. (S.S.)..5.0 x 2.0 x 1.2..11.8
 Weight complete 4500 lbs.

D.....	\$277.00
F.....	263.00
G.....	256.00
H.....	249.00
I.....	242.00
K.....	232.00
L.....	221.00

"M. M." finish

No. 5211

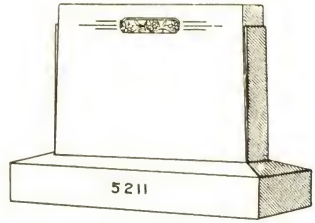

Die.....4.0 x 1.2 x 3.0..14.0
 B. Ba. (S.S.)..5.0 x 2.0 x 1.2..11.8
 Weight complete 4500 lbs.

D.....	\$273.00
F.....	259.00
G.....	252.00
H.....	245.00
I.....	238.00
K.....	228.00
L.....	217.00

"M. M." finish

No. 5210¹/₄

Die.....3.6 x 1.0 x 2.8..9.4
 B. Ba. (S.S.)..4.6 x 1.10 x 1.0..8.3
 Weight complete 3000 lbs.

D.....	\$201.00
F.....	191.00
G.....	187.00
H.....	182.00
I.....	177.00
K.....	170.00
L.....	163.00

"M. M." finish

No. 5211¹/₄

Die.....3.6 x 1.0 x 2.8..9.4
 B. Ba. (S.S.)..4.6 x 1.10 x 1.0..8.3
 Weight complete 3000 lbs.

D.....	\$204.00
F.....	194.00
G.....	190.00
H.....	185.00
I.....	180.00
K.....	173.00
L.....	166.00

"M. M." finish

No. 5210¹/₂

Die.....3.6 x 0.10 x 2.8..7.9
 B. Ba. (S.S.)..4.6 x 1.8 x 1.0..7.6
 Weight complete 2650 lbs.

D.....	\$176.00
F.....	168.00
G.....	164.00
H.....	160.00
I.....	157.00
K.....	151.00
L.....	145.00

"M. M." finish

No. 5211¹/₂

Die.....3.6 x 0.10 x 2.8..7.9
 B. Ba. (S.S.)..4.6 x 1.8 x 1.0..7.6
 Weight complete 2650 lbs.

D.....	\$179.00
F.....	171.00
G.....	167.00
H.....	163.00
I.....	160.00
K.....	154.00
L.....	148.00

"M. M." finish

No. 5210³/₄

Die.....3.6 x 0.8 x 2.8..6.3
 B. Ba. (S.S.)..4.6 x 1.6 x 1.0..6.9
 Weight complete 2275 lbs.

D.....	\$152.00
F.....	146.00
G.....	143.00
H.....	140.00
I.....	137.00
K.....	132.00
L.....	127.00

"M. M." finish

No. 5211³/₄

Die.....3.6 x 0.8 x 2.8..6.3
 B. Ba. (S.S.)..4.6 x 1.6 x 1.0..6.9
 Weight complete 2275 lbs.

D.....	\$155.00
F.....	149.00
G.....	146.00
H.....	143.00
I.....	140.00
K.....	135.00
L.....	130.00

"M. M." finish

No. 5212

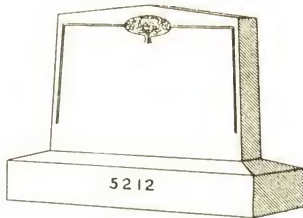

Die.....4.0 x 1.2 x 3.0 .14.0
 B. Ba. (S.S.)..5.0 x 2.0 x 1.2 .11.8
 Weight complete 4500 lbs.

D.....	\$277.00
F.....	263.00
G.....	256.00
H.....	249.00
I.....	242.00
K.....	232.00
L.....	221.00

"M. M." finish

No. 5212¹/₄

Die.....3.6 x 1.0 x 2.8 .9.4
 B. Ba. (S.S.)..4.6 x 1.10 x 1.0 .8.3
 Weight complete 3000 lbs.

D.....	\$201.00
F.....	191.00
G.....	187.00
H.....	182.00
I.....	177.00
K.....	170.00
L.....	163.00

"M. M." finish

No. 5212¹/₂

Die.....3.6 x 0.10 x 2.8 .7.9
 B. Ba. (S.S.)..4.6 x 1.8 x 1.0 .7.6
 Weight complete 2650 lbs.

D.....	\$176.00
F.....	168.00
G.....	164.00
H.....	160.00
I.....	157.00
K.....	151.00
L.....	145.00

"M. M." finish

No. 5212³/₄

Die.....3.6 x 0.8 x 2.8 .6.3
 B. Ba. (S.S.)..4.6 x 1.6 x 1.0 .6.9
 Weight complete 2275 lbs.

D.....	\$152.00
F.....	146.00
G.....	143.00
H.....	140.00
I.....	137.00
K.....	132.00
L.....	127.00

"M. M." finish

No. 5213

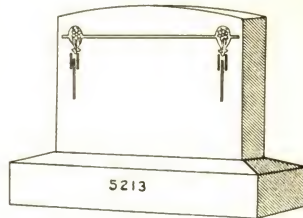

Die.....4.0 x 1.2 x 3.0 .14.0
 B. Ba. (S.S.)..5.0 x 2.0 x 1.2 .11.8
 Weight complete 4500 lbs.

D.....	\$277.00
F.....	263.00
G.....	256.00
H.....	249.00
I.....	242.00
K.....	232.00
L.....	221.00

"M. M." finish

No. 5213¹/₄

Die.....3.6 x 1.0 x 2.6 .8.9
 B. Ba. (S.S.)..4.6 x 1.10 x 1.0 .8.3
 Weight complete 2900 lbs.

D.....	\$193.00
F.....	184.00
G.....	180.00
H.....	175.00
I.....	169.00
K.....	163.00
L.....	156.00

"M. M." finish

No. 5213¹/₂

Die.....3.6 x 0.10 x 2.6 .7.4
 B. Ba. (S.S.)..4.6 x 1.8 x 1.0 .7.6
 Weight complete 2575 lbs.

D.....	\$171.00
F.....	163.00
G.....	159.00
H.....	155.00
I.....	152.00
K.....	146.00
L.....	140.00

"M. M." finish

No. 5213³/₄

Die.....3.6 x 0.8 x 2.6 .5.10
 B. Ba. (S.S.)..4.6 x 1.6 x 1.0 .6.9
 Weight complete 2200 lbs.

D.....	\$147.00
F.....	141.00
G.....	138.00
H.....	135.00
I.....	132.00
K.....	127.00
L.....	122.00

"M. M." finish

No. 5214

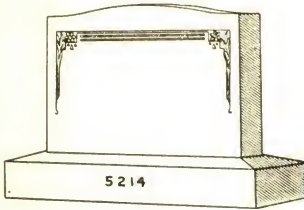

Die..... 4.0 x 1.2 x 2.10..13.3
 B. Ba. (S.S.).. 5.0 x 2.0 x 1. 2. .11.8
 Weight complete 4350 lbs.

D.....	\$303.00
F.....	289.00
G.....	283.00
H.....	276.00
I.....	270.00
K.....	260.00
L.....	250.00

"M. M." finish

No. 5214¹/₄

Die..... 3.6 x 1. 0 x 2.6..8.9
 B. Ba. (S.S.).. 4.6 x 1.10 x 1.0..8.3
 Weight complete 2900 lbs.

D.....	\$232.00
F.....	224.00
G.....	219.00
H.....	215.00
I.....	211.00
K.....	204.00
L.....	197.00

"M. M." finish

No. 5214¹/₂

Die..... 3.6 x 0.10 x 2.6..7.4
 B. Ba. (S.S.).. 4.6 x 1. 8 x 1.0..7.6
 Weight complete 2575 lbs.

D.....	\$210.00
F.....	202.00
G.....	199.00
H.....	195.00
I.....	191.00
K.....	186.00
L.....	180.00

"M. M." finish

No. 5214³/₄

Die..... 3.6 x 0.8 x 2.6..5.10
 B. Ba. (S.S.).. 4.6 x 1.6 x 1.0..6. 9
 Weight complete 2200 lbs.

D.....	\$186.00
F.....	180.00
G.....	177.00
H.....	174.00
I.....	171.00
K.....	167.00
L.....	163.00

"M. M." finish

No. 5215

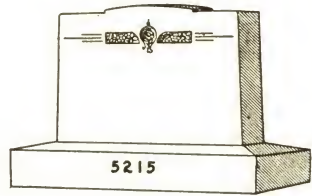

Die..... 4.0 x 1.2 x 3.0..14.0
 B. Ba. (S.S.).. 5.0 x 2.0 x 1.2..11.8
 Weight complete 4500 lbs.

D.....	\$318.00
F.....	304.00
G.....	297.00
H.....	290.00
I.....	283.00
K.....	273.00
L.....	262.00

"M. M." finish

No. 5215¹/₄

Die..... 3.6 x 1. 0 x 2.8..9.4
 B. Ba. (S.S.).. 4.6 x 1.10 x 1.0..8.3
 Weight complete 3000 lbs.

D.....	\$247.00
F.....	237.00
G.....	233.00
H.....	228.00
I.....	223.00
K.....	216.00
L.....	209.00

"M. M." finish

No. 5215¹/₂

Die..... 3.6 x 0.10 x 2.8..7.9
 B. Ba. (S.S.).. 4.6 x 1. 8 x 1.0..7.6
 Weight complete 2650 lbs.

D.....	\$220.00
F.....	212.00
G.....	208.00
H.....	204.00
I.....	201.00
K.....	195.00
L.....	189.00

"M. M." finish

No. 5215³/₄

Die..... 3.6 x 0.8 x 2.8..6.3
 B. Ba. (S.S.).. 4.6 x 1.6 x 1.0..6.9
 Weight complete 2275 lbs.

D.....	\$195.00
F.....	189.00
G.....	186.00
H.....	183.00
I.....	180.00
K.....	175.00
L.....	170.00

"M. M." finish

No. 5216

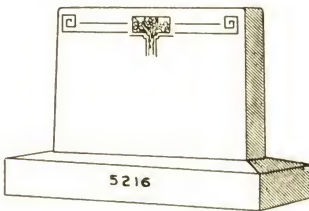

Die.....	4.0 x 1.2 x 2.10	.13.3
B. Ba. (S.S.)	5.0 x 2.0 x 1.2	.11.8
Weight complete 4350 lbs.		
D.....		\$280.00
F.....		266.00
G.....		260.00
H.....		253.00
I.....		247.00
K.....		237.00
L.....		227.00

"M. M." finish

No. 5216¹/₄

Die.....	3.6 x 1.0 x 2.6	.8.9
B. Ba. (S.S.)	4.6 x 1.10 x 1.0	.8.3
Weight complete 2900 lbs.		
D.....		\$211.00
F.....		203.00
G.....		198.00
H.....		194.00
I.....		190.00
K.....		183.00
L.....		176.00

"M. M." finish

No. 5216¹/₂

Die.....	3.6 x 0.10 x 2.6	.7.4
B. Ba. (S.S.)	4.6 x 1.8 x 1.0	.7.6
Weight complete 2575 lbs.		
D.....		\$191.00
F.....		183.00
G.....		180.00
H.....		176.00
I.....		172.00
K.....		167.00
L.....		161.00

"M. M." finish

No. 5216³/₄

Die.....	3.6 x 0.8 x 2.6	.5.10
B. Ba. (S.S.)	4.6 x 1.6 x 1.0	.6.9
Weight complete 2200 lbs.		
D.....		\$168.00
F.....		162.00
G.....		159.00
H.....		156.00
I.....		153.00
K.....		149.00
L.....		145.00

"M. M." finish

No. 5217

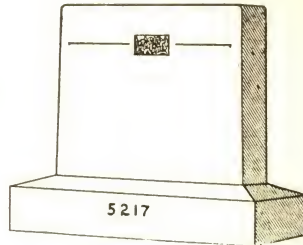

Die.....	4.0 x 1.2 x 3.0	.14.0
B. Ba. (S.S.)	5.0 x 2.0 x 1.2	.11.8
Weight complete 4500 lbs.		
D.....		\$265.00
F.....		251.00
G.....		244.00
H.....		237.00
I.....		230.00
K.....		220.00
L.....		209.00

"M. M." finish

No. 5217¹/₄

Die.....	3.6 x 1.0 x 2.8	.9.4
B. Ba. (S.S.)	4.6 x 1.10 x 1.0	.8.3
Weight complete 3000 lbs.		
D.....		\$194.00
F.....		184.00
G.....		180.00
H.....		175.00
I.....		170.00
K.....		163.00
L.....		156.00

"M. M." finish

No. 5217¹/₂

Die.....	3.6 x 0.10 x 2.8	.7.9
B. Ba. (S.S.)	4.6 x 1.8 x 1.0	.7.6
Weight complete 2650 lbs.		
D.....		\$170.00
F.....		162.00
G.....		158.00
H.....		154.00
I.....		151.00
K.....		145.00
L.....		139.00

"M. M." finish

No. 5217³/₄

Die.....	3.6 x 0.8 x 2.8	.6.3
B. Ba. (S.S.)	4.6 x 1.6 x 1.0	.6.9
Weight complete 2275 lbs.		
D.....		\$146.00
F.....		140.00
G.....		137.00
H.....		134.00
I.....		131.00
K.....		126.00
L.....		121.00

"M. M." finish

No. 5218

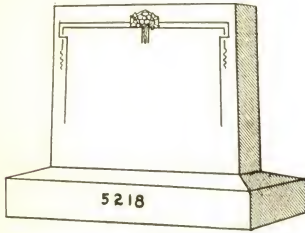

Die..... 4.0 x 1.2 x 3.0 ..14.0
 B. Ba. (S.S.).. 5.0 x 2.0 x 1.2 ..11.8
 Weight complete 4500 lbs.
 D..... \$257.00
 F..... 243.00
 G..... 236.00
 H..... 229.00
 I..... 222.00
 K..... 212.00
 L..... 201.00
 "M. M." finish

No. 5218¹/₄

Die..... 3.6 x 1.0 x 2.8 ..9.4
 B. Ba. (S.S.).. 4.6 x 1.10 x 1.0 ..8.3
 Weight complete 3000 lbs.
 D..... \$188.00
 F..... 178.00
 G..... 174.00
 H..... 169.00
 I..... 164.00
 K..... 157.00
 L..... 150.00
 "M. M." finish

No. 5218¹/₂

Die..... 3.6 x 0.10 x 2.8 ..7.9
 B. Ba. (S.S.).. 4.6 x 1.8 x 1.0 ..7.6
 Weight complete 2650 lbs.
 D..... \$165.00
 F..... 157.00
 G..... 153.00
 H..... 150.00
 I..... 146.00
 K..... 140.00
 L..... 134.00
 "M. M." finish

No. 5218³/₄

Die..... 3.6 x 0.8 x 2.8 ..6.3
 B. Ba. (S.S.).. 4.6 x 1.6 x 1.0 ..6.9
 Weight complete 2275 lbs.
 D..... \$142.00
 F..... 136.00
 G..... 133.00
 H..... 130.00
 I..... 127.00
 K..... 122.00
 L..... 117.00
 "M. M." finish

No. 5219

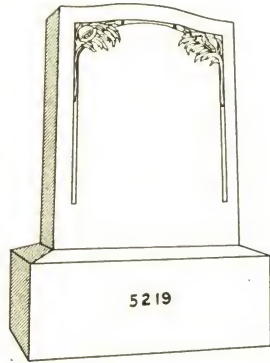

Die..... 2.4 x 0.10 x 3.0 ..5.10
 B. Ba. (S.S.).. 2.10 x 1.4 x 1.0 ..3.9
 Weight complete 1700 lbs.
 D..... \$124.00
 F..... 118.00
 G..... 115.00
 H..... 112.00
 I..... 109.00
 K..... 105.00
 L..... 101.00
 "M. M." finish

No. 5219¹/₄

Die..... 2.0 x 0.8 x 2.6 ..3.4
 B. Ba. (S.S.).. 2.6 x 1.2 x 1.0 ..2.11
 Weight complete 1050 lbs.
 D..... \$86.50
 F..... 83.50
 G..... 81.50
 H..... 80.00
 I..... 78.50
 K..... 76.00
 L..... 73.50
 "M. M." finish

No. 5219¹/₂

Die..... 1.8 x 0.6 x 2.4 ..1.11
 B. Ba. (S.S.).. 2.2 x 1.0 x 0.10 ..1.10
 Weight complete 650 lbs.
 D..... \$62.00
 F..... 60.00
 G..... 59.00
 H..... 58.00
 I..... 57.00
 K..... 55.50
 L..... 54.50
 "M. M." finish

No. 5220

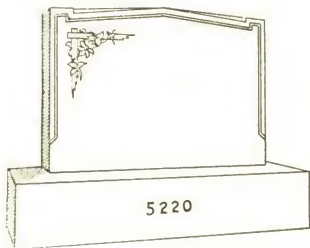

Die.....4.0 x 1.2 x 2.10..13.3
 B. Ba. (S.S.)..5.0 x 2.0 x 1. 2..11.8
 Weight complete 4350 lbs.

D.....	\$255.00
F.....	241.00
G.....	235.00
H.....	228.00
I.....	222.00
K.....	212.00
L.....	202.00

"M. M." finish

No. 5220¹/₄

Die.....3.6 x 1. 0 x 2.6..8.9
 B. Ba. (S.S.)..4.6 x 1.10 x 1.0..8.3
 Weight complete 2900 lbs.

D.....	\$181.00
F.....	173.00
G.....	168.00
H.....	164.00
I.....	160.00
K.....	153.00
L.....	146.00

"M. M." finish

No. 5220¹/₂

Die.....3.6 x 0.10 x 2.6..7.4
 B. Ba. (S.S.)..4.6 x 1. 8 x 1.0..7.6
 Weight complete 2575 lbs.

D.....	\$160.00
F.....	152.00
G.....	149.00
H.....	145.00
I.....	141.00
K.....	136.00
L.....	130.00

"M. M." finish

No. 5220³/₄

Die.....3.6 x 0.8 x 2.6..5.10
 B. Ba. (S.S.)..4.6 x 1.6 x 1.0..6.9
 Weight complete 2200 lbs.

D.....	137.00
F.....	131.00
G.....	128.00
H.....	125.00
I.....	122.00
K.....	118.00
L.....	114.00

"M. M." finish

No. 5221

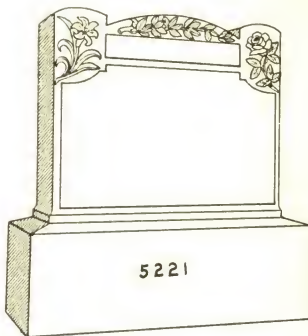

Die.....3.0 x 1.0 x 2.4..7.0
 B. Base.....3.6 x 1.6 x 1.0..5.3
 Weight complete 2050 lbs.; no B. B.1105 lbs.

D.....	\$151.00
F.....	145.00
G.....	141.00
H.....	138.00
I.....	134.00
K.....	129.00
L.....	124.00

If B. B. is omitted deduct \$18.40

No. 5221¹/₄

Die.....3.0 x 0.10 x 2.4..5.10
 B. Base.....3.6 x 1. 4 x 1.0..4. 8
 Weight complete 1800 lbs.; no B. B. 960 lbs.

D.....	\$135.00
F.....	129.00
G.....	126.00
H.....	123.00
I.....	120.00
K.....	116.00
L.....	112.00

If B. B. is omitted deduct \$16.35

No. 5221¹/₂

Die.....3.0 x 0.8 x 2.4..4.8
 B. Base.....3.6 x 1.2 x 1.0..4.1
 Weight complete 1500 lbs.; no B. B. 765 lbs.

D.....	\$118.00
F.....	114.00
G.....	111.00
H.....	109.00
I.....	107.00
K.....	103.00
L.....	99.50

If B. B. is omitted deduct \$14.30

No. 5222

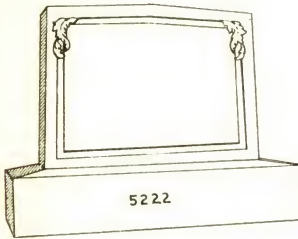

Die.....4.0 x 1.2 x 2.10..13.3
 B.Ba. (S.S.)..5.0 x 2.0 x 1. 2..11.8
 Weight complete 4350 lbs.

D.....	\$255.00
F.....	241.00
G.....	235.00
H.....	228.00
I.....	222.00
K.....	212.00
L.....	202.00

"M. M." finish

No. 5222¹/₄

Die.....3.6 x 1. 0 x 2.6..8.9
 B. Ba. (S.S.)..4.6 x 1. 10 x 1.0..8.3
 Weight complete 2900 lbs.

D.....	\$181.00
F.....	173.00
G.....	168.00
H.....	164.00
I.....	160.00
K.....	153.00
L.....	146.00

"M. M." finish

No. 5222¹/₂

Die.....3.6 x 0.10 x 2.6..7.4
 B. Ba. (S.S.)..4.6 x 1. 8 x 1.0..7.6
 Weight complete 2575 lbs.

D.....	\$160.00
F.....	152.00
G.....	149.00
H.....	145.00
I.....	141.00
K.....	136.00
L.....	130.00

"M. M." finish

No. 5222³/₄

Die.....3.6 x 0.8 x 2.6..5.10
 B. Ba. (S.S.)..4.6 x 1.6 x 1.0..6.9
 Weight complete 2200 lbs.

D.....	\$137.00
F.....	131.00
G.....	128.00
H.....	125.00
I.....	122.00
K.....	118.00
L.....	114.00

"M. M." finish

No. 5223

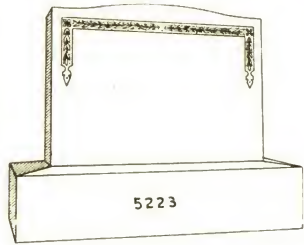

Die.....4.0 x 1.2 x 2.10..13.3
 B.Ba. (S.S.)..5.0 x 2.0 x 1. 2..11.8
 Weight complete 4350 lbs.

D.....	\$275.00
F.....	261.00
G.....	255.00
H.....	248.00
I.....	242.00
K.....	232.00
L.....	222.00

"M. M." finish

No. 5223¹/₄

Die.....3.6 x 1. 0 x 2.6..8.9
 B. Ba. (S.S.)..4.6 x 1.10 x 1.0..8.3
 Weight complete 2900 lbs.

D.....	\$201.00
F.....	192.00
G.....	188.00
H.....	183.00
I.....	178.00
K.....	171.00
L.....	164.00

"M. M." finish

No. 5223¹/₂

Die.....3.6 x 0.10 x 2.6..7.4
 B. Ba. (S.S.)..4.6 x 1. 8 x 1.0..7.6
 Weight complete 2575 lbs.

D.....	\$180.00
F.....	172.00
G.....	169.00
H.....	165.00
I.....	161.00
K.....	156.00
L.....	150.00

"M. M." finish

No. 5223³/₄

Die.....3.6 x 0.8 x 2.6..5.10
 B. Ba. (S.S.)..4.6 x 1.6 x 1.0..6.9
 Weight complete 2200 lbs.

D.....	\$156.00
F.....	150.00
G.....	147.00
H.....	144.00
I.....	141.00
K.....	137.00
L.....	133.00

"M. M." finish

No. 5224

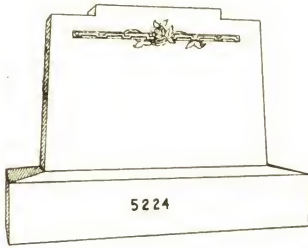

Die.....4.0 x 1.2 x 2.10..13.3
 B.Ba. (S.S.)..5.0 x 2.0 x 1. 2..11.8
 Weight complete 4350 lbs.

D.....	\$264.00
F.....	250.00
G.....	244.00
H.....	237.00
I.....	231.00
K.....	221.00
L.....	211.00

"M. M." finish

No. 5224¹/₄

Die.....3.6 x 1. 0 x 2.6..8.9
 B. Ba. (S.S.)..4.6 x 1.10 x 1.0..8.3
 Weight complete 2900 lbs.

D.....	\$196.00
F.....	187.00
G.....	183.00
H.....	178.00
I.....	173.00
K.....	166.00
L.....	159.00

"M. M." finish

No. 5224¹/₂

Die.....3.6 x 0.10 x 2.6..7.4
 B. Ba. (S.S.)..4.6 x 1. 8 x 1.0..7.6
 Weight complete 2575 lbs.

D.....	\$175.00
F.....	167.00
G.....	164.00
H.....	160.00
I.....	156.00
K.....	151.00
L.....	145.00

"M. M." finish

No. 5224³/₄

Die.....3.6 x 0.8 x 2.6..5.10
 B. Ba. (S.S.)..4.6 x 1.6 x 1.0..6. 9
 Weight complete 2100 lbs.

D.....	\$151.00
F.....	145.00
G.....	142.00
H.....	139.00
I.....	136.00
K.....	132.00
L.....	128.00

"M. M." finish

No. 5225

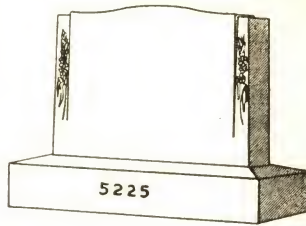

Die.....4.4 x 1.2 x 3.4..16.10
 B.Ba. (S.S.)..5.4 x 2.0 x 1.2..12. 5
 Weight complete 5000 lbs.

D.....	\$368.00
F.....	352.00
G.....	343.00
H.....	335.00
I.....	326.00
K.....	314.00
L.....	300.00

"M. M." finish

No. 5225¹/₄

Die.....4.0 x 1. 0 x 3.0..12.0
 B.Ba. (S.S.)..5.0 x 1.10 x 1.0.. 9.2
 Weight complete 3700 lbs.

D.....	\$291.00
F.....	279.00
G.....	273.00
H.....	267.00
I.....	261.00
K.....	252.00
L.....	243.00

"M. M." finish

No. 5225¹/₂

Die.....3.8 x 0.10 x 2.8..8.2
 B. Ba. (S.S.)..4.8 x 1. 8 x 1.0..7.9
 Weight complete 2700 lbs.

D.....	\$234.00
F.....	226.00
G.....	222.00
H.....	218.00
I.....	214.00
K.....	208.00
L.....	200.00

"M. M." finish

No. 5225³/₄

Die.....3.6 x 0.8 x 2.6..5.10
 B. Ba. (S.S.)..4.6 x 1.6 x 1.0..6. 9
 Weight complete 2200 lbs.

D.....	\$195.00
F.....	189.00
G.....	186.00
H.....	183.00
I.....	180.00
K.....	176.00
L.....	172.00

"M. M." finish

No. 5226

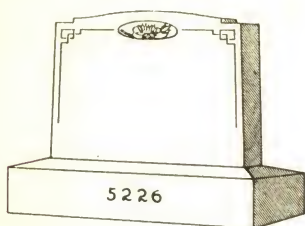

Die..... 4.0 x 1.2 x 3.0 ..14.0
 B. Ba. (S.S.).. 5.0 x 2.0 x 1.2 ..11.8
 Weight complete 4500 lbs.

D.....	\$279.00
F.....	265.00
G.....	258.00
H.....	251.00
I.....	244.00
K.....	234.00
L.....	223.00

"M. M." finish

No. 5226¹/₄

Die..... 3.8 x 1.0 x 2.10 ..10.5
 B. Ba. (S.S.).. 4.8 x 1.10 x 1.0 ..8.7
 Weight complete 3300 lbs.

D.....	\$223.00
F.....	213.00
G.....	208.00
H.....	202.00
I.....	197.00
K.....	189.00
L.....	182.00

"M. M." finish

No. 5226¹/₂

Die..... 3.8 x 0.10 x 2.10 ..8.8
 B. Ba. (S.S.).. 4.8 x 1.8 x 1.0 ..7.9
 Weight complete 2950 lbs.

D.....	\$197.00
F.....	189.00
G.....	184.00
H.....	180.00
I.....	176.00
K.....	169.00
L.....	163.00

"M. M." finish

No. 5226³/₄

Die..... 3.8 x 0.8 x 2.10 ..6.11
 B. Ba. (S.S.).. 4.8 x 1.6 x 1.0 ..7.0
 Weight complete 2450 lbs.

D.....	\$170.00
F.....	164.00
G.....	160.00
H.....	157.00
I.....	153.00
K.....	148.00
L.....	143.00

"M. M." finish

No. 5227

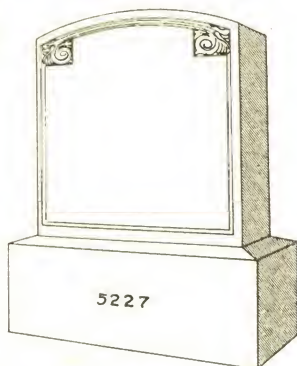

Die..... 2.6 x 1.0 x 2.6 ..6.3
 B. Base..... 3.0 x 1.6 x 1.0 ..4.6
 Weight complete 2000 lbs.; no B. B. 1055 lbs.

D.....	\$115.00
F.....	109.00
G.....	106.00
H.....	103.00
I.....	100.00
K.....	95.00
L.....	90.00

If B. B. is omitted deduct \$15.75

No. 5227¹/₄

Die..... 2.4 x 0.10 x 2.4 ..4.6
 B. Base..... 2.10 x 1.4 x 1.0 ..3.9
 Weight complete 1425 lbs.; no B. B. 750 lbs.

D.....	\$100.00
F.....	86.00
G.....	83.50
H.....	81.00
I.....	79.00
K.....	75.50
L.....	72.00

If B. B. is omitted deduct \$13.15

No. 5227¹/₂

Die..... 2.2 x 0.8 x 2.2 ..3.2
 B. Base..... 2.8 x 1.2 x 1.0 ..3.1
 Weight complete 1075 lbs.; no B. B. 520 lbs.

D.....	\$71.50
F.....	68.50
G.....	67.00
H.....	65.50
I.....	63.50
K.....	61.50
L.....	59.00

If B. B. is omitted deduct \$10.80

No. 5228

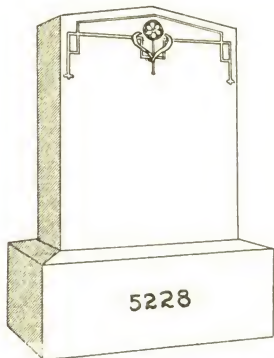

Die.....2.0 x 1.0 x 2.6..5.0
 B. Base.....2.6 x 1.6 x 1.0..3.9
 Weight complete 1575 lbs.; no B. B. 900 lbs.
 G.....\$76.50
 H.....74.00
 I.....71.50
 K.....68.00
 L.....64.00
 If B. B. is omitted deduct \$13.15
 Face only polished; balance sand finished

No. 5228¹/₄

Die.....2.0 x 0.10 x 2.6..4.2
 B. Base.....2.6 x 1.4 x 1.0..3.4
 Weight complete 1350 lbs.; no B. B. 750 lbs.
 G.....\$65.00
 H.....63.00
 I.....60.50
 K.....57.50
 L.....54.50
 If B. B. is omitted deduct \$11.65
 Face only polished; balance sand finished

No. 5228¹/₂

Die.....2.0 x 0.8 x 2.6..3.4
 B. Base.....2.6 x 1.2 x 1.0..2.11
 Weight complete 1100 lbs.; no B. B. 575 lbs.
 G.....\$55.50
 H.....54.00
 I.....52.50
 K.....49.75 ²⁰⁰
 L.....47.25
 If B. B. is omitted deduct \$10.50
 Face only polished; balance sand finished

No. 5228³/₄

Die.....1.8 x 0.6 x 2.4..1.11
 B. Base.....2.2 x 1.0 x 0.10..1.10
 Weight complete 675 lbs.; no B. B. 345 lbs.
 G.....\$35.50
 H.....34.50
 I.....33.75
 K.....32.25
 L.....30.75
 If B. B. is omitted deduct \$6.60
 Face only polished; balance sand finished

No. 5229

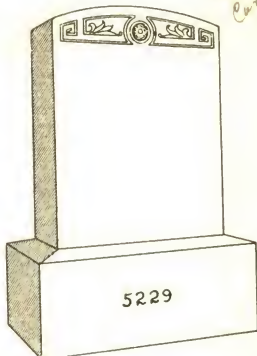

Die.....2.0 x 1.0 x 2.6..5.0
 B. Base.....2.6 x 1.6 x 1.0..3.9
 Weight complete 1575 lbs.; no B. B. 900 lbs.
 G.....\$76.50
 H.....74.00
 I.....71.50
 K.....68.00
 L.....64.00
 If B. B. is omitted deduct \$13.15
 Face only polished; balance sand finished

No. 5229¹/₄

Die.....2.0 x 0.10 x 2.6..4.2
 B. Base.....2.6 x 1.4 x 1.0..3.4
 Weight complete 1350 lbs.; no B. B. 750 lbs.
 G.....\$65.00
 H.....63.00
 I.....60.50
 K.....57.50
 L.....54.50
 If B. B. is omitted deduct \$11.65
 Face only polished; balance sand finished

No. 5229¹/₂

Die.....2.0 x 0.8 x 2.6..3.4
 B. Base.....2.6 x 1.2 x 1.0..2.11
 Weight complete 1100 lbs.; no B. B. 575 lbs.
 G.....\$55.50
 H.....54.00
 I.....52.50
 K.....49.75 ²⁰⁰
 L.....47.25
 If B. B. is omitted deduct \$10.50
 Face only polished; balance sand finished

No. 5229³/₄

Die.....1.8 x 0.6 x 2.4..1.11
 B. Base.....2.2 x 1.0 x 0.10..1.10
 Weight complete 675 lbs.; no B. B. 345 lbs.
 G.....\$35.50
 H.....34.50
 I.....33.75
 K.....32.25
 L.....30.75
 If B. B. is omitted deduct \$6.60
 Face only polished; balance sand finished

No. 5230

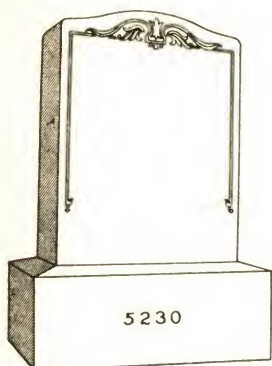

Die.....2.0 x 1.0 x 2.6 .50
 B. Base.....2.6 x 1.6 x 1.0 .39
 Weight complete 1575 lbs.; no B. B. 900 lbs.
 G.....\$76.50
 H.....74.00
 I.....71.50
 K.....68.00
 L.....64.00
 If B. B. is omitted deduct \$13.15
 Face only polished; balance sand finished

No. 5230¹/₄

Die.....2.0 x 0.10 x 2.6 .42
 B. Base.....2.6 x 1.4 x 1.0 .34
 Weight complete 1350 lbs.; no B. B. 750 lbs.
 G.....\$65.00
 H.....63.00
 I.....60.50
 K.....57.50
 L.....54.50
 If B. B. is omitted deduct \$11.65
 Face only polished; balance sand finished

No. 5230¹/₂

Die.....2.0 x 0.8 x 2.6 .34
 B. Base.....2.6 x 1.2 x 1.0 .211
 Weight complete 1100 lbs.; no B. B. 575 lbs.
 G.....\$55.50
 H.....54.00
 I.....52.50
 K.....49.75 ²⁰⁰
 L.....47.25
 If B. B. is omitted deduct \$10.50
 Face only polished; balance sand finished

No. 5230³/₄

Die.....1.8 x 0.6 x 2.4 .111
 B. Base.....2.2 x 1.0 x 0.10 .110
 Weight complete 675 lbs.; no B. B. 345 lbs.
 G.....\$35.50
 H.....34.50
 I.....33.75
 K.....32.25
 L.....30.75
 If B. B. is omitted deduct \$6.60
 Face only polished; balance sand finished

No. 5231

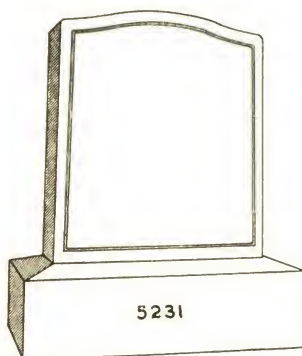

Die.....2.8 x 1.0 x 3.0 .80
 B. Ba. (S.S.)...3.4 x 1.8 x 1.0 .57
 Weight complete 2300 lbs.
 D.....\$143.00
 F.....135.00
 G.....131.00
 H.....127.00
 I.....123.00
 K.....117.00
 L.....111.00

All sand finished

No. 5231¹/₄

Die.....2.6 x 0.10 x 2.10 .511
 B. Ba. (S.S.)...3.2 x 1.6 x 1.0 .49
 Weight complete 1800 lbs.
 D.....\$113.00
 F.....107.00
 G.....104.00
 H.....101.00
 I.....98.00
 K.....94.00
 L.....89.00

All sand finished

No. 5231¹/₂

Die.....2.4 x 0.8 x 2.8 .42
 B. Ba. (S.S.)...3.0 x 1.4 x 1.0 .40
 Weight complete 1400 lbs.
 D.....\$87.00
 F.....83.00
 G.....81.00
 H.....79.00
 I.....76.50
 K.....73.50
 L.....70.50

All sand finished

No. 5232

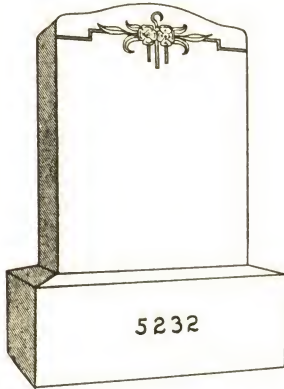

Die.....2.0 x 1.0 x 2.6..5.0
 B. Ba. (S.S.)...2.6 x 1.6 x 1.0..3.9
 Weight complete 1575 lbs.
 G.....\$89.00
 H.....86.50
 I.....84.00
 K.....80.50
 L.....76.50
 "M. M." finish

No. 5232¹/₄

Die.....2.0 x 0.10 x 2.6..4.2
 B. Ba. (S.S.)...2.6 x 1.4 x 1.0..3.4
 Weight complete 1350 lbs.
 G.....\$78.00
 H.....76.00
 I.....73.50
 K.....70.50
 L.....67.50
 "M. M." finish

No. 5232¹/₂

Die.....2.0 x 0.8 x 2.6..3.4
 B. Ba. (S.S.)...2.6 x 1.2 x 1.0..2.11
 Weight complete 1100 lbs.
 G.....\$66.50
 H.....65.00
 I.....63.50
 K.....61.00
 L.....58.50
 "M. M." finish

No. 5232³/₄

Die.....1.8 x 0.6 x 2.4..1.11
 B. Ba. (S.S.)...2.2 x 1.0 x 0.10..1.10
 Weight complete 675 lbs.
 G.....\$45.00
 H.....44.00
 I.....43.25
 K.....41.75
 L.....40.25
 "M. M." finish

No. 5233

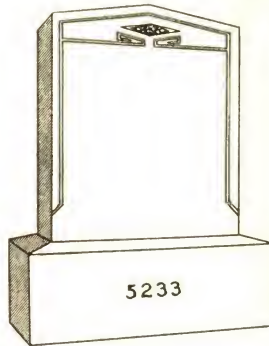

Die.....2.0 x 1.0 x 2.6..5.0
 B. Ba. (S.S.)...2.6 x 1.6 x 1.0..3.9
 Weight complete 1575 lbs.
 G.....\$89.00
 H.....86.50
 I.....84.00
 K.....80.50
 L.....76.50
 "M. M." finish

No. 5233¹/₄

Die.....2.0 x 0.10 x 2.6..4.2
 B. Ba. (S.S.)...2.6 x 1.4 x 1.0..3.4
 Weight complete 1350 lbs.
 G.....\$78.00
 H.....76.00
 I.....73.50
 K.....70.50
 L.....67.50
 "M. M." finish

No. 5233¹/₂

Die.....2.0 x 0.8 x 2.6..3.4
 B. Ba. (S.S.)...2.6 x 1.2 x 1.0..2.11
 Weight complete 1100 lbs.
 G.....\$66.50
 H.....65.00
 I.....63.50
 K.....61.00
 L.....58.50
 "M. M." finish

No. 5233³/₄

Die.....1.8 x 0.6 x 2.4..1.11
 B. Ba. (S.S.)...2.2 x 1.0 x 0.10..1.10
 Weight complete 675 lbs.
 G.....\$45.00
 H.....44.00
 I.....43.25
 K.....41.75
 L.....40.25
 "M. M." finish

No. 5234

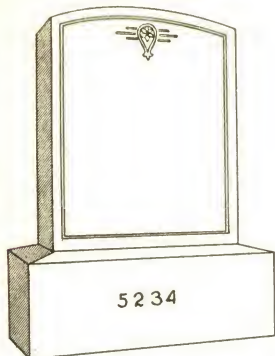

Die.....2.0 x 1.0 x 2.6 .50
 B. Ba. (S.S.)...2.6 x 1.6 x 1.0 .39
 Weight complete 1575 lbs.

D.....	\$96.50
F.....	91.50
G.....	89.00
H.....	86.50
I.....	84.00
K.....	80.50
L.....	76.50

"M. M." finish

No. 5234¹/₄

Die.....2.0 x 0.10 x 2.6 .42
 B. Ba. (S.S.)...2.6 x 1.4 x 1.0 .34
 Weight complete 1350 lbs.

D.....	\$84.00
F.....	80.00
G.....	78.00
H.....	76.00
I.....	73.50
K.....	70.50
L.....	67.50

"M. M." finish

No. 5234¹/₂

Die.....2.0 x 0.8 x 2.6 .3.4
 B. Ba. (S.S.)...2.6 x 1.2 x 1.0 .2.11
 Weight complete 1100 lbs.

D.....	\$71.50
F.....	68.50
G.....	66.50
H.....	65.00
I.....	63.50
K.....	61.00
L.....	58.50

"M. M." finish

No. 5234³/₄

Die.....1.8 x 0.6 x 2.4 .1.11
 B. Ba. (S.S.)...2.2 x 1.0 x 0.10 .1.10
 Weight complete 675 lbs.

D.....	\$48.00
F.....	46.00
G.....	45.00
H.....	44.00
I.....	43.25
K.....	41.75
L.....	40.25

"M. M." finish

No. 5235

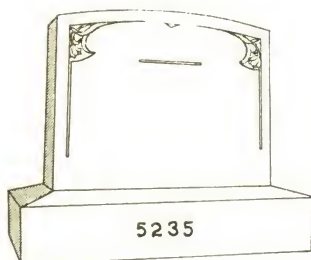

Die.....4.0 x 1.2 x 3.0 .14.0
 B. Ba. (S.S.)...5.0 x 2.0 x 1.2 .11.8
 Weight complete 4500 lbs.

D.....	\$271.00
F.....	257.00
G.....	250.00
H.....	243.00
I.....	236.00
K.....	226.00
L.....	215.00

"M. M." finish

No. 5235¹/₄

Die.....3.6 x 1.0 x 2.8 .9.4
 B. Ba. (S.S.)...4.6 x 1.10 x 1.0 .8.3
 Weight complete 3000 lbs.

D.....	\$194.00
F.....	184.00
G.....	180.00
H.....	175.00
I.....	170.00
K.....	163.00
L.....	156.00

"M. M." finish

No. 5235¹/₂

Die.....3.6 x 0.10 x 2.8 .7.9
 B. Ba. (S.S.)...4.6 x 1.8 x 1.0 .7.6
 Weight complete 2650 lbs.

D.....	\$167.00
F.....	159.00
G.....	155.00
H.....	151.00
I.....	148.00
K.....	142.00
L.....	136.00

"M. M." finish

No. 5235³/₄

Die.....3.6 x 0.8 x 2.8 .6.3
 B. Ba. (S.S.)...4.6 x 1.6 x 1.0 .6.9
 Weight complete 2275 lbs.

D.....	\$143.00
F.....	137.00
G.....	134.00
H.....	131.00
I.....	128.00
K.....	123.00
L.....	118.00

"M. M." finish

No. 5236

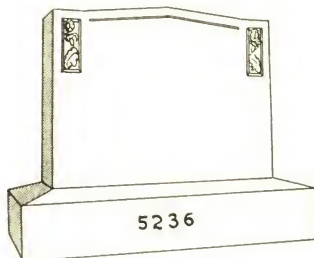

Die.....4.0 x 1.2 x 3.0..14.0
 B. Ba. (S.S.)..5.0 x 2.0 x 1.2..11.8

Weight complete 4500 lbs.

- D.....\$277.00
- F.....263.00
- G.....256.00
- H.....249.00
- I.....242.00
- K.....232.00
- L.....221.00

"M. M." finish

No. 5236¹/₄

Die.....3.6 x 1.0 x 2.8..9.4
 B. Ba. (S.S.)..4.6 x 1.10 x 1.0..8.3

Weight complete 3000 lbs.

- D.....\$206.00
- F.....196.00
- G.....192.00
- H.....187.00
- I.....182.00
- K.....175.00
- L.....168.00

"M. M." finish

No. 5236¹/₂

Die.....3.6 x 0.10 x 2.8..7.9
 B. Ba. (S.S.)..4.6 x 1.8 x 1.0..7.6

Weight complete 2650 lbs.

- D.....\$179.00
- F.....171.00
- G.....167.00
- H.....163.00
- I.....160.00
- K.....154.00
- L.....148.00

"M. M." finish

No. 5236³/₄

Die.....3.6 x 0.8 x 2.8..6.3
 B. Ba. (S.S.)..4.6 x 1.6 x 1.0..6.9

Weight complete 2275 lbs.

- D.....\$155.00
- F.....149.00
- G.....146.00
- H.....143.00
- I.....140.00
- K.....135.00
- L.....130.00

"M. M." finish

No. 5237

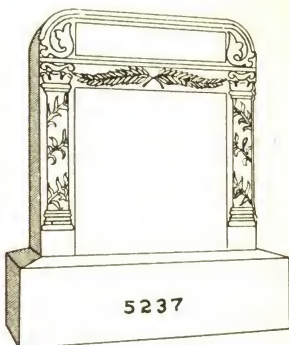

Die.....2.6 x 1.0 x 2.8..6.8
 B. Base.....3.0 x 1.6 x 1.0..4.6

Weight complete 2000 lbs.; no B.B.1190 lbs.

- D.....\$103.00
- F.....96.50
- G.....93.50
- H.....90.00
- I.....86.50
- K.....81.50
- L.....76.50

If B. B. is omitted deduct \$15.75

No. 5237¹/₄

Die.....2.4 x 0.10 x 2.6..4.10
 B. Base...2.10 x 1.4 x 1.0..3.9

Weight complete 1525 lbs.; no B. B. 850 lbs.

- D.....\$77.50
- F.....72.50
- G.....70.00
- H.....68.00
- I.....65.50
- K.....61.50
- L.....58.00

If B. B. is omitted deduct \$13.15

No. 5237¹/₂

Die.....2.2 x 0.8 x 2.4..3.4
 B. Base.....2.8 x 1.2 x 1.0..3.1

Weight complete 1150 lbs.; no B. B. 600 lbs.

- D.....\$56.50
- F.....53.50
- G.....51.50
- H.....50.00
- I.....48.50
- K.....45.75
- L.....43.25

If B. B. is omitted deduct \$10.80

No. 5238

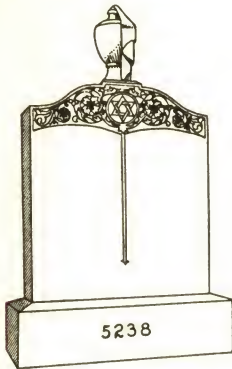

Urn.....0.10 x 0.10 x 1.6.. 1.1
 Die.....3. 6 x 0.10 x 4.0..11.8
 B. Base...4. 0 x 1. 4 x 1.0.. 5.4
 Weight complete 3100 lbs.; no B.B. 2110 lbs.

- D.....\$214.00
- F..... 202.00
- G..... 196.00
- H..... 190.00
- I..... 184.00
- K..... 174.00
- L..... 165.00

If B. B. is omitted deduct \$18.85
 Face of die polished; balance sand finished.

No. 5238¹/₄

Urn.....0.8 x 0.8 x 1.4..0.7
 Die.....3.0 x 0.8 x 3.6..7.0
 B. Base...3.6 x 1.2 x 1.0.. 4.1
 Weight complete 1900 lbs.; no B.B. 1165 lbs.

- D.....\$146.00
- F..... 138.00
- G..... 134.00
- H..... 131.00
- I..... 127.00
- K..... 121.00
- L..... 115.00

If B. B. is omitted deduct \$14.30
 Face of die polished; balance sand finished.

No. 5238¹/₂

Urn.....0.6 x 0.6 x 1. 2..0.4
 Die.....2.6 x 0.6 x 3. 0..3.9
 B. Base...3.0 x 1.0 x 0.10..2.6
 Weight complete 1100 lbs.; no B. B. 650 lbs.

- D.....\$97.00
- F..... 93.00
- G..... 91.00
- H..... 89.00
- I..... 87.00
- K..... 84.00
- L..... 81.00

If B. B. is omitted deduct \$9.00
 Face of die polished; balance sand finished.

No. 5239

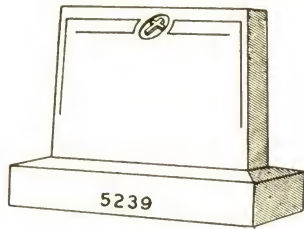

Die.....4.0 x 1.2 x 3.0..14.0
 B. Ba. (S.S.)..5.0 x 2.0 x 1.2..11.8
 Weight complete 4500 lbs.

- D.....\$254.00
- F..... 240.00
- G..... 233.00
- H..... 226.00
- I..... 219.00
- K..... 209.00
- L..... 198.00

"M. M." finish

No. 5239¹/₄

Die.....3.6 x 1. 0 x 2.8..9.4
 B. Ba. (S.S.)..4.6 x 1.10 x 1.0..8.3
 Weight complete 3000 lbs.

- D.....\$183.00
- F..... 173.00
- G..... 169.00
- H..... 164.00
- I..... 159.00
- K..... 152.00
- L..... 145.00

"M. M." finish

No. 5239¹/₂

Die.....3.6 x 0.10 x 2.8..7.9
 B. Ba. (S.S.)..4.6 x 1. 8 x 1.0..7.6
 Weight complete 2650 lbs.

- D.....\$158.00
- F..... 150.00
- G..... 146.00
- H..... 142.00
- I..... 139.00
- K..... 133.00
- L..... 127.00

"M. M." finish

No. 5239³/₄

Die.....3.6 x 0.8 x 2.8..6.3
 B. Ba. (S.S.)..4.6 x 1.6 x 1.0..6.9
 Weight complete 2275 lbs.

- D.....\$135.00
- F..... 129.00
- G..... 126.00
- H..... 123.00
- I..... 120.00
- K..... 115.00
- L..... 110.00

"M. M." finish

No. 5240

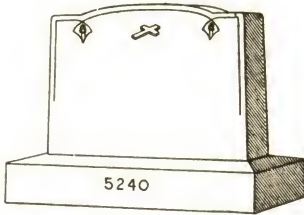

Die.....4.0 x 1.2 x 3.0..14.0
 B. Ba. (S.S.)..5.0 x 2.0 x 1.2..11.8
 Weight complete 4500 lbs.

D.....	\$274.00
F.....	260.00
G.....	253.00
H.....	246.00
I.....	239.00
K.....	229.00
L.....	218.00

"M. M." finish

No. 5240¹/₄

Die.....3.6 x 1.0 x 2.8..9.4
 B. Ba. (S.S.)..4.6 x 1.10 x 1.0..8.3
 Weight complete 3000 lbs.

D.....	\$203.00
F.....	193.00
G.....	189.00
H.....	184.00
I.....	179.00
K.....	172.00
L.....	165.00

"M. M." finish

No. 5240¹/₂

Die.....3.6 x 0.10 x 2.8..7.9
 B. Ba. (S.S.)..4.6 x 1.8 x 1.0..7.6
 Weight complete 2650 lbs.

D.....	\$177.00
F.....	169.00
G.....	165.00
H.....	161.00
I.....	158.00
K.....	152.00
L.....	146.00

"M. M." finish

No. 5240³/₄

Die.....3.6 x 0.8 x 2.8..6.3
 B. Ba. (S.S.)..4.6 x 1.6 x 1.0..6.9
 Weight complete 2275 lbs.

D.....	\$153.00
F.....	147.00
G.....	144.00
H.....	141.00
I.....	138.00
K.....	133.00
L.....	128.00

"M. M." finish

No. 5241

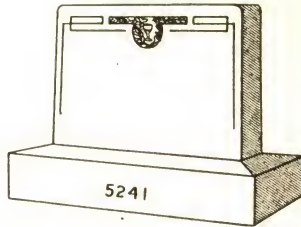

Die.....4.0 x 1.2 x 3.0..14.0
 B. Ba. (S.S.)..5.0 x 2.0 x 1.2..11.8
 Weight complete 4500 lbs.

D.....	\$287.00
F.....	273.00
G.....	266.00
H.....	259.00
I.....	252.00
K.....	242.00
L.....	231.00

"M. M." finish

No. 5241¹/₄

Die.....3.6 x 1.0 x 2.8..9.4
 B. Ba. (S.S.)..4.6 x 1.10 x 1.0..8.3
 Weight complete 3000 lbs.

D.....	\$215.00
F.....	205.00
G.....	201.00
H.....	196.00
I.....	191.00
K.....	184.00
L.....	177.00

"M. M." finish

No. 5241¹/₂

Die.....3.6 x 0.10 x 2.8..7.9
 B. Ba. (S.S.)..4.6 x 1.8 x 1.0..7.6
 Weight complete 2650 lbs.

D.....	\$189.00
F.....	181.00
G.....	177.00
H.....	173.00
I.....	170.00
K.....	164.00
L.....	158.00

"M. M." finish

No. 5241³/₄

Die.....3.6 x 0.8 x 2.8..6.3
 B. Ba. (S.S.)..4.6 x 1.6 x 1.0..6.9
 Weight complete 2275 lbs.

D.....	\$168.00
F.....	162.00
G.....	159.00
H.....	156.00
I.....	153.00
K.....	148.00
L.....	142.00

"M. M." finish

No. 5242

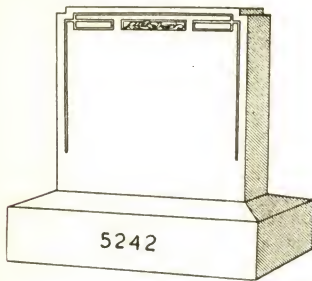

Die.....2.6 x 1.0 x 2.6 . .6.3
 B. Base.....3.0 x 1.6 x 1.2 . .5.3
 Weight complete 2000 lbs.; no B.B.1055 lbs.

D.....\$111.00
 F.....105.00
 G.....102.00
 H.....99.50
 I.....95.50
 K.....91.00
 L.....86.00

If B. B. is omitted deduct \$18.40
 Face only polished

No. 5243

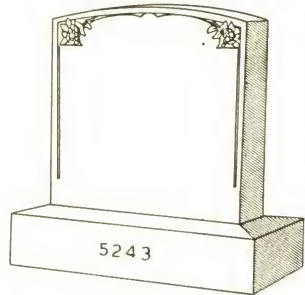

Die.....2.6 x 1.0 x 2.6 . .6.3
 B. Base.....3.0 x 1.6 x 1.2 . .5.3
 Weight complete 2000 lbs.; no B.B.1055 lbs.

D.....\$111.00
 F.....105.00
 G.....102.00
 H.....99.50
 I.....95.50
 K.....91.00
 L.....86.00

If B. B. is omitted deduct \$18.40
 Face only polished

No. 5242¹/₄

Die.....2.4 x 0.10 x 2.4 . .4.6
 B. Base.....2.10 x 1.4 x 1.2 . .4.5
 Weight complete 1575 lbs.; no B. B. 780 lbs.

D.....\$86.00
 F.....82.00
 G.....79.50
 H.....77.50
 I.....75.00
 K.....71.50
 L.....68.50

If B. B. is omitted deduct \$15.45
 Face only polished

No. 5243¹/₄

Die.....2.4 x 0.10 x 2.4 . .4.6
 B. Base.....2.10 x 1.4 x 1.2 . .4.5
 Weight complete 1575 lbs.; no B. B. 780 lbs.

D.....\$86.00
 F.....82.00
 G.....79.50
 H.....77.50
 I.....75.00
 K.....71.50
 L.....68.50

If B. B. is omitted deduct \$15.45
 Face only polished

No. 5242¹/₂

Die.....2.0 x 0.8 x 2.0 . .2.8
 B. Base.....2.6 x 1.2 x 1.0 . .2.11
 Weight complete 1000 lbs.; no B. B. 475 lbs.

D.....\$57.50
 F.....54.50
 G.....53.50
 H.....52.00
 I.....50.50
 K.....48.75
 L.....46.75

If B. B. is omitted deduct \$10.50
 Face only polished

No. 5243¹/₂

Die.....2.0 x 0.8 x 2.0 . .2.8
 B. Base.....2.6 x 1.2 x 1.0 . .2.11
 Weight complete 1000 lbs.; no B. B. 475 lbs.

D.....\$57.50
 F.....54.50
 G.....53.50
 H.....52.00
 I.....50.50
 K.....48.75
 L.....46.75

If B. B. is omitted deduct \$10.50
 Face only polished

No. 5244

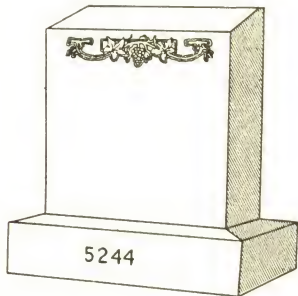

Die.....2.6 x 1.0 x 2.6...6.3
 B. Base.....3.0 x 1.6 x 1.2...5.3
 Weight complete 2000 lbs.; no B. B. 1055 lbs.

D.....	\$111.00
F.....	105.00
G.....	102.00
H.....	99.50
I.....	95.50
K.....	91.00
L.....	86.00

If B. B. is omitted deduct \$18.40
 Face and top polished

No. 5244¹/₄

Die.....2.4 x 0.10 x 2.4...4.6
 B. Base.....2.10 x 1.4 x 1.2...4.5
 Weight complete 1575 lbs.; no B. B. 780 lbs.

D.....	\$86.00
F.....	82.00
G.....	79.50
H.....	77.50
I.....	75.00
K.....	71.50
L.....	68.50

If B. B. is omitted deduct \$15.45
 Face and top polished

No. 5244¹/₂

Die.....2.0 x 0.8 x 2.0...2.8
 B. Base.....2.6 x 1.2 x 1.0...2.11
 Weight complete 1000 lbs.; no B. B. 475 lbs.

D.....	\$57.50
F.....	54.50
G.....	53.50
H.....	52.00
I.....	50.50
K.....	48.75
L.....	46.75

If B. B. is omitted deduct \$10.50
 Face and top polished

No. 5245

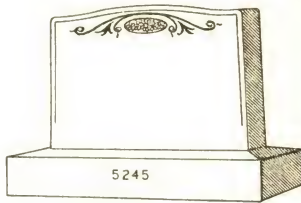

Die.....4.0 x 1.2 x 3.0...14.0
 B. Ba. (S.S.)...5.0 x 2.0 x 1.2...11.8
 Weight complete 4500 lbs.

D.....	\$284.00
F.....	270.00
G.....	263.00
H.....	256.00
I.....	249.00
K.....	239.00
L.....	228.00

"M. M." finish

No. 5245¹/₄

Die.....3.6 x 1.0 x 2.8...9.4
 B. Ba. (S.S.)...4.6 x 1.10 x 1.0...8.3
 Weight complete 3000 lbs.

D.....	\$200.00
F.....	190.00
G.....	186.00
H.....	181.00
I.....	176.00
K.....	169.00
L.....	162.00

"M. M." finish

No. 5245¹/₂

Die.....3.6 x 0.10 x 2.8...7.9
 B. Ba. (S.S.)...4.6 x 1.8 x 1.0...7.6
 Weight complete 2650 lbs.

D.....	\$174.00
F.....	166.00
G.....	162.00
H.....	158.00
I.....	155.00
K.....	149.00
L.....	143.00

"M. M." finish

No. 5245³/₄

Die.....3.6 x 0.8 x 2.8...6.3
 B. Ba. (S.S.)...4.6 x 1.6 x 1.0...6.9
 Weight complete 2275 lbs.

D.....	\$149.00
F.....	143.00
G.....	140.00
H.....	137.00
I.....	134.00
K.....	129.00
L.....	124.00

"M. M." finish

No. 5246

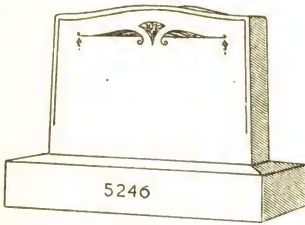

Die.....4.0 x 1.2 x 3.0..14.0
 B. Ba. (S.S.)..5.0 x 2.0 x 1.2..11.8
 Weight complete 4500 lbs.
 D.....\$282.00
 F.....268.00
 G.....261.00
 H.....254.00
 I.....247.00
 K.....237.00
 L.....226.00
 "M. M." finish

No. 5246¹/₄

Die.....3.6 x 1.0 x 2.8..9.4
 B. Ba. (S.S.)..4.6 x 1.10 x 1.0..8.3
 Weight complete 3000 lbs.
 D.....\$198.00
 F.....188.00
 G.....184.00
 H.....179.00
 I.....174.00
 K.....167.00
 L.....160.00
 "M. M." finish

No. 5246¹/₂

Die.....3.6 x 0.10 x 2.8..7.9
 B. Ba. (S.S.)..4.6 x 1.8 x 1.0..7.6
 Weight complete 2650 lbs.
 D.....\$172.00
 F.....164.00
 G.....160.00
 H.....156.00
 I.....153.00
 K.....147.00
 L.....141.00
 "M. M." finish

No. 5246³/₄

Die.....3.6 x 0.8 x 2.8..6.3
 B. Ba. (S.S.)..4.6 x 1.6 x 1.0..6.9
 Weight complete 2275 lbs.
 D.....\$147.00
 F.....141.00
 G.....138.00
 H.....135.00
 I.....132.00
 K.....127.00
 L.....122.00
 "M. M." finish

No. 5247

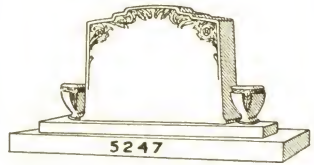

Die.....4.6 x 0.11 x 3.2..13.1
 Base.....8.4 x 2.3 x 1.0..18.10
 2 Vases...1.0 x 1.0 x 1.0..2.0
 Weight complete 5800 lbs.
 D.....\$706.00
 F.....682.00
 G.....665.00
 H.....658.00
 I.....631.00
 K.....606.00
 L.....580.00

No. 5248

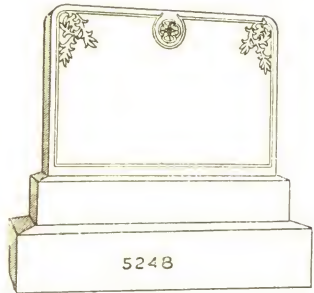

Die.....2.8 x 0.6 x 2.0..2.8
 Base.....2.11 x 0.9 x 0.6..1.1
 B. Base...3.4 x 1.2 x 0.10..3.3
 Weight complete 1350 lbs.; no B. B. 765 lbs.
 D.....\$64.50
 F.....60.50
 G.....59.00
 H.....57.00
 I.....55.00
 K.....52.00
 L.....49.50
 If B. B. is omitted deduct \$11.40

No. 5248¹/₄

Die.....2.8 x 0.4 x 2.0..1.9
 Base.....2.11 x 0.7 x 0.5..0.9
 B. Base...3.4 x 1.0 x 0.10..2.9
 Weight complete 945 lbs.; no B. B. 450 lbs.
 D.....\$48.00
 F.....45.75
 G.....44.50
 H.....43.25
 I.....42.00
 K.....40.00
 L.....38.25
 If B. B. is omitted deduct \$9.90

No. 5249

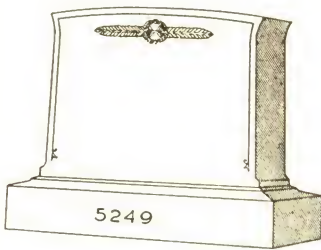

Die.....4.0 x 1.2 x 3.0..14.0
 B. Ba. (S.S.)..5.0 x 2.0 x 1.2..11.8
 Weight complete 4600 lbs.
 D.....\$318.00
 F.....304.00
 G.....297.00
 H.....290.00
 I.....283.00
 K.....273.00
 L.....262.00
 "M. M." finish

No. 5249¹/₄

Die.....3.6 x 1.0 x 2.8..9.4
 B. Ba. (S.S.)..4.6 x 1.10 x 1.0..8.3
 Weight complete 3100 lbs.
 D.....\$241.00
 F.....231.00
 G.....227.00
 H.....222.00
 I.....217.00
 K.....210.00
 L.....203.00
 "M. M." finish

No. 5249¹/₂

Die.....3.6 x 0.10 x 2.8..7.9
 B. Ba. (S.S.)..4.6 x 1.8 x 1.0..7.6
 Weight complete 2745 lbs.
 D.....\$215.00
 F.....207.00
 G.....203.00
 H.....199.00
 I.....196.00
 K.....190.00
 L.....184.00
 "M. M." finish

No. 5249³/₄

Die.....3.6 x 0.8 x 2.8. 6.3
 B. Ba. (S.S.)..4.6 x 1.6 x 1.0..6.9
 Weight complete 2300 lbs.
 D.....\$190.00
 F.....184.00
 G.....181.00
 H.....178.00
 I.....175.00
 K.....170.00
 L.....165.00
 "M. M." finish

No. 5250

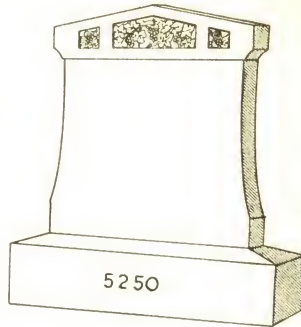

Die.....3.0 x 1.0 x 3.4..10.0
 B.Ba. (S.S.)..3.10 x 1.8 x 1.0.. 6.5
 Weight complete 2800 lbs.
 D.....\$215.00
 F.....210.00
 G.....205.00
 H.....200.00
 I.....195.00
 K.....188.00
 L.....180.00
 "M. M." finish

No. 5250¹/₄

Die.....3.0 x 0.10 x 3.4..8.4
 B.Ba. (S.S.)..3.10 x 1.6 x 1.0..5.9
 Weight complete 2400 lbs.
 D.....\$194.00
 F.....186.00
 G.....182.00
 H.....178.00
 I.....173.00
 K.....167.00
 L.....161.00
 "M. M." finish

No. 5250¹/₂

Die.....3.0 x 0.8 x 3.4..6.8
 B. Base (S.S.)..3.10 x 1.4 x 1.0..5.1
 Weight complete 2000 lbs.
 D.....\$168.00
 F.....162.00
 G.....158.00
 H.....155.00
 I.....152.00
 K.....147.00
 L.....142.00

No. 5251

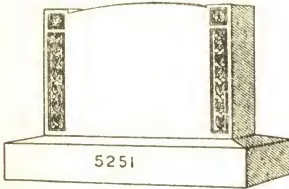

Die..... 4.0 x 1.2 x 2.10... 13.3
 B.Ba. (S.S.) 5.0 x 2.0 x 1. 2... 11.8
 Weight complete 4350 lbs.

D.....	\$327.00
F.....	313.00
G.....	307.00
H.....	300.00
I.....	294.00
K.....	284.00
L.....	274.00

"M. M." finish

No. 5251¹/₄

Die..... 4.0 x 1. 0 x 2.10... 11.4
 B.Ba. (S.S.) 5.0 x 1.10 x 1. 0... 9.2
 Weight complete 3550 lbs.

D.....	\$291.00
F.....	279.00
G.....	274.00
H.....	268.00
I.....	262.00
K.....	254.00
L.....	245.00

"M. M." finish

No. 5251¹/₂

Die..... 4.0 x 0.10 x 2.10... 9.5
 B.Ba. (S.S.) 5.0 x 1. 8 x 1. 0... 8.4
 Weight complete 3050 lbs.

D.....	\$263.00
F.....	253.00
G.....	249.00
H.....	244.00
I.....	239.00
K.....	232.00
L.....	225.00

"M. M." finish

No. 5251³/₄

Die..... 3.8 x 0.8 x 2.6... 6.1
 B. Ba. (S.S.) 4.8 x 1.4 x 1.0... 6.3
 Weight complete 2150 lbs.

D.....	\$205.00
F.....	199.00
G.....	196.00
H.....	193.00
I.....	190.00
K.....	185.00
L.....	181.00

"M. M." finish

No. 5252

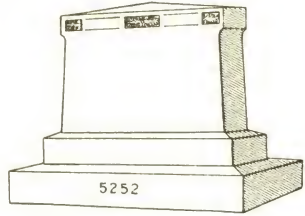

Die..... 4.0 x 1.2 x 3.0... 14.0
 Base..... 4.6 x 1.8 x 0.8... 5.0
 B. Ba. (S.S.) 5.4 x 2.6 x 1.0... 13.4
 Weight complete 5600 lbs.

D.....	\$369.00
F.....	351.00
G.....	341.00
H.....	332.00
I.....	322.00
K.....	308.00
L.....	294.00

"M. M." finish

No. 5252¹/₄

Die..... 3.6 x 1.0 x 2.8... 9.4
 Base..... 4.0 x 1.6 x 0.8... 4.0
 B. Ba. (S.S.) 4.10 x 2.4 x 1.0... 11.3
 Weight complete 4175 lbs.

D.....	\$287.00
F.....	273.00
G.....	267.00
H.....	260.00
I.....	253.00
K.....	243.00
L.....	233.00

"M. M." finish

No. 5252¹/₂

Die..... 3.6 x 0.10 x 2.8... 7.9
 Base..... 4.0 x 1.4 x 0.8... 3.7
 B. Ba. (S.S.) 4.10 x 2.2 x 0.10... 8.9
 Weight complete 3450 lbs.

D.....	\$236.00
F.....	234.00
G.....	229.00
H.....	223.00
I.....	217.00
K.....	209.00
L.....	200.00

"M. M." finish

No. 5252³/₄

Die..... 3.6 x 0.8 x 2.8... 6.3
 Base..... 4.0 x 1.2 x 0.6... 2.4
 B. Ba. (S.S.) 4.10 x 2.0 x 0.10... 8.1
 Weight complete 2875 lbs.

D.....	\$212.00
F.....	204.00
G.....	199.00
H.....	195.00
I.....	191.00
K.....	185.00
L.....	178.00

"M. M." finish

No. 5253

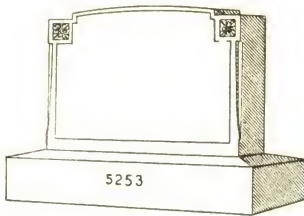

Die.....4.0 x 1.2 x 2.10..13.3
 B. Ba. (S.S.) .5.0 x 2.0 x 1.2..11.8
 Weight complete 4350 lbs.

D.....	\$272.00
F.....	258.00
G.....	252.00
H.....	245.00
I.....	239.00
K.....	229.00
L.....	219.00

"M. M." finish

No. 5253¹/₄

Die.....3.6 x 1.0 x 2.8..9.4
 B. Ba. (S.S.) .4.6 x 1.10 x 1.0..8.3
 Weight complete 3000 lbs.

D.....	\$213.00
F.....	203.00
G.....	199.00
H.....	194.00
I.....	189.00
K.....	182.00
L.....	175.00

"M. M." finish

No. 5253¹/₂

Die.....3.6 x 0.10 x 2.8..7.9
 B. Ba. (S.S.) .4.6 x 1.8 x 1.0..7.6
 Weight complete 2650 lbs.

D.....	\$188.00
F.....	180.00
G.....	176.00
H.....	172.00
I.....	169.00
K.....	163.00
L.....	157.00

"M. M." finish

No. 5253³/₄

Die.....3.6 x 0.8 x 2.8..6.3
 B. Ba. (S.S.) .4.6 x 1.6 x 1.0..6.9
 Weight complete 2275 lbs.

D.....	\$169.00
F.....	163.00
G.....	160.00
H.....	157.00
I.....	154.00
K.....	149.00
L.....	144.00

"M. M." finish

No. 5254

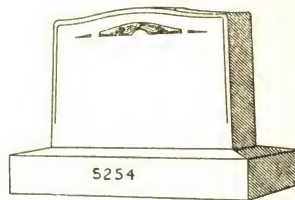

Die.....4.0 x 1.2 x 3.0..14.0
 B. Ba. (S.S.) .5.0 x 2.0 x 1.2..11.8
 Weight complete 4350 lbs.

D.....	\$282.00
F.....	268.00
G.....	261.00
H.....	254.00
I.....	247.00
K.....	237.00
L.....	226.00

"M. M." finish

No. 5254¹/₄

Die.....3.6 x 1.0 x 2.8..9.4
 B. Ba. (S.S.) .4.6 x 1.10 x 1.0..8.3
 Weight complete 3000 lbs.

D.....	\$198.00
F.....	188.00
G.....	184.00
H.....	179.00
I.....	174.00
K.....	167.00
L.....	160.00

"M. M." finish

No. 5254¹/₂

Die.....3.6 x 0.10 x 2.8..7.9
 B. Ba. (S.S.) .4.6 x 1.8 x 1.0..7.6
 Weight complete 2650 lbs.

D.....	\$172.00
F.....	164.00
G.....	160.00
H.....	156.00
I.....	153.00
K.....	147.00
L.....	141.00

"M. M." finish

No. 5254³/₄

Die.....3.6 x 0.8 x 2.8..6.3
 B. Ba. (S.S.) .4.6 x 1.6 x 1.0..6.9
 Weight complete 2275 lbs.

D.....	\$147.00
F.....	141.00
G.....	138.00
H.....	135.00
I.....	132.00
K.....	127.00
L.....	122.00

"M. M." finish

No. 5255

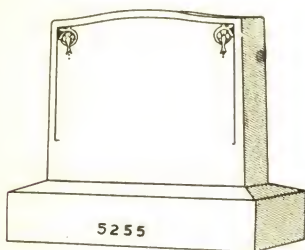

Die.....3.4 x 1.0 x 3.0..10.0
 B. Ba. (S.S.) .4.2 x 1.8 x 1.0..6.11
 Weight complete 2800 lbs.

- D.....\$195.00
- F.....185.00
- G.....180.00
- H.....175.00
- I.....170.00
- K.....163.00
- L.....155.00

"M. M." finish

No. 5255¹/₄

Die.....3.4 x 0.10 x 3.0..8.4
 B. Ba. (S.S.) .4.2 x 1.6 x 1.0..6.3
 Weight complete 2500 lbs.

- D.....\$169.00
- F.....161.00
- G.....157.00
- H.....153.00
- I.....148.00
- K.....142.00
- L.....136.00

"M. M." finish

No. 5255¹/₂

Die.....3.4 x 0.8 x 3.0..6.8
 B. Ba. (S.S.) .4.2 x 1.4 x 1.0..5.7
 Weight complete 2100 lbs.

- D.....\$144.00
- F.....138.00
- G.....134.00
- H.....131.00
- I.....128.00
- K.....123.00
- L.....118.00

"M. M." finish

No. 5256

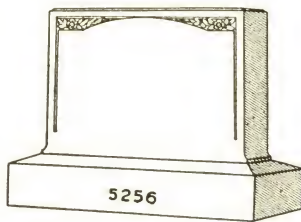

Die.....4.4 x 1.2 x 2.6..12.8
 B. Ba. (S.S.) .5.4 x 2.0 x 1.0..10.8
 Weight complete 3900 lbs.

- D.....\$276.00
- F.....264.00
- G.....257.00
- H.....251.00
- I.....245.00
- K.....235.00
- L.....226.00

"M. M." finish

No. 5256¹/₄

Die.....4.4 x 1.0 x 2.6..10.10
 B. Ba. (S.S.) .5.4 x 1.10 x 1.0..9.9
 Weight complete 3450 lbs.

- D.....\$249.00
- F.....239.00
- G.....233.00
- H.....228.00
- I.....222.00
- K.....214.00
- L.....206.00

"M. M." finish

No. 5256¹/₂

Die.....4.0 x 0.10 x 2.6..8.4
 B. Ba. (S.S.) .5.0 x 1.8 x 1.0..8.4
 Weight complete 2800 lbs.

- D.....\$209.00
- F.....200.00
- G.....195.00
- H.....190.00
- I.....186.00
- K.....178.00
- L.....171.00

"M. M." finish

No. 5256³/₄

Die.....3.6 x 0.8 x 2.6..5.10
 B. Ba. (S.S.) .4.6 x 1.4 x 1.0..6.0
 Weight complete 2000 lbs.

- D.....\$161.00
- F.....155.00
- G.....152.00
- H.....149.00
- I.....146.00
- K.....142.00
- L.....138.00

"M. M." finish

No. 5257

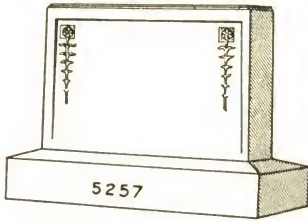

Die..... 4.2 x 1.2 x 2.6 ..12.2
 B. Ba. (S.S.) . . 5.2 x 2.0 x 1.0 . .10.4
 Weight complete 3800 lbs.
 D.....\$281.00
 F..... 269.00
 G..... 263.00
 H..... 257.00
 I..... 251.00
 K..... 242.00
 L..... 232.00
 "M. M." finish

No. 5257¹/₄

Die..... 4.2 x 1.0 x 2.6 ..10.5
 B. Ba. (S.S.) . . 5.2 x 1.10 x 1.0 . . 9.6
 Weight complete 3300 lbs.
 D.....\$253.00
 F..... 243.00
 G..... 238.00
 H..... 232.00
 I..... 227.00
 K..... 219.00
 L..... 212.00
 "M. M." finish

No. 5257¹/₂

Die..... 4.0 x 0.10 x 2.6 ..8.4
 B. Ba. (S.S.) . . 5.0 x 1.8 x 1.0 . .8.4
 Weight complete 2900 lbs.
 D.....\$222.00
 F..... 214.00
 G..... 210.00
 H..... 206.00
 I..... 201.00
 K..... 195.00
 L..... 189.00
 "M. M." finish

No. 5257³/₄

Die..... 4.0 x 0.8 x 2.6 ..6.8
 B. Ba. (S.S.) . . 5.0 x 1.4 x 1.0 . .6.8
 Weight complete 2300 lbs.
 D.....\$193.00
 F..... 187.00
 G..... 183.00
 H..... 180.00
 I..... 177.00
 K..... 172.00
 L..... 167.00
 "M. M." finish

No. 5258

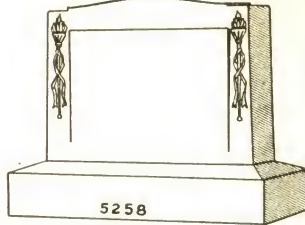

Die..... 4.0 x 1.2 x 3.0 ..14.0
 B. Ba. (S.S.) . . 5.0 x 2.0 x 1.2 . .11.8
 Weight complete 4500 lbs.
 D.....\$292.00
 F..... 278.00
 G..... 271.00
 H..... 264.00
 I..... 257.00
 K..... 247.00
 L..... 236.00
 "M. M." finish

No. 5258¹/₄

Die..... 4.0 x 1.0 x 3.0 ..12.0
 B. Ba. (S.S.) . . 5.0 x 1.10 x 1.0 . . 9.2
 Weight complete 3500 lbs.
 D.....\$253.00
 F..... 241.00
 G..... 235.00
 H..... 229.00
 I..... 223.00
 K..... 214.00
 L..... 205.00
 "M. M." finish

No. 5258¹/₂

Die..... 3.6 x 0.10 x 2.8 ..7.9
 B. Ba. (S.S.) . . 4.6 x 1.8 x 1.0 . .7.6
 Weight complete 2650 lbs.
 D.....\$192.00
 F..... 184.00
 G..... 180.00
 H..... 176.00
 I..... 173.00
 K..... 167.00
 L..... 161.00
 "M. M." finish

No. 5258³/₄

Die..... 3.6 x 0.8 x 2.8 ..6.3
 B. Ba. (S.S.) . . 4.6 x 1.4 x 1.0 . .6.0
 Weight complete 2150 lbs.
 D.....\$165.00
 F..... 159.00
 G..... 156.00
 H..... 153.00
 I..... 150.00
 K..... 145.00
 L..... 140.00
 "M. M." finish

No. 5259

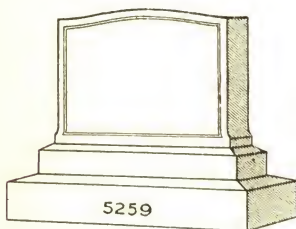

Die..... 4. 2 x 1.0 x 3.0.. 12.6
 Base..... 4.10 x 1.8 x 0.8.. 5.4
 B.Ba. (S.S.) . 5.10 x 2.8 x 1.0.. 15.7

Weight complete 6000 lbs.

D..... \$328.00
 F..... 310.00
 G..... 301.00
 H..... 292.00
 I..... 283.00
 K..... 270.00
 L..... 257.00

"M. M." finish

No. 5259¹/₄

Die..... 3. 6 x 0.10 x 2. 6.. 7.4
 Base..... 4. 0 x 1. 4 x 0. 6.. 2.8
 B.Ba. (S.S.) . 4.10 x 2. 2 x 0.10.. 8.9

Weight complete 3350 lbs.

D..... \$194.00
 F..... 184.00
 G..... 179.00
 H..... 174.00
 I..... 169.00
 K..... 162.00
 L..... 154.00

"M. M." finish

No. 5259¹/₂

Die..... 3. 6 x 0.8 x 2. 6.. 5.10
 Base..... 4. 0 x 1.2 x 0. 6.. 2. 4
 B.Ba. (S.S.) . 4.10 x 2.0 x 0.10.. 8. 1

Weight complete 2900 lbs.

D..... \$168.00
 F..... 160.00
 G..... 156.00
 H..... 152.00
 I..... 148.00
 K..... 142.00
 L..... 135.00

"M. M." finish

No. 5260

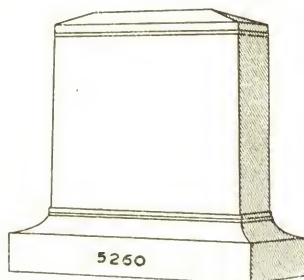

Die..... 3.0 x 1.2 x 2.8.. 9.4
 B. Ba. (S.S.) . 4.0 x 2.0 x 1.2.. 9.4

Weight complete 3325 lbs.

D..... \$209.00
 F..... 199.00
 G..... 195.00
 H..... 190.00
 I..... 185.00
 K..... 178.00
 L..... 171.00

"M. M." finish

No. 5260¹/₄

Die..... 3.0 x 1. 0 x 2.8.. 8.0
 B. Ba. (S.S.) . 4.0 x 1.10 x 1.2.. 8.7

Weight complete 2900 lbs.

D..... \$188.00
 F..... 180.00
 G..... 176.00
 H..... 172.00
 I..... 168.00
 K..... 162.00
 L..... 156.00

"M. M." finish

No. 5260¹/₂

Die..... 3.0 x 0.10 x 2.8.. 6.8
 B. Ba. (S.S.) . 4.0 x 1. 8 x 1.2.. 7.9

Weight complete 2550 lbs.

D..... \$166.00
 F..... 160.00
 G..... 156.00
 H..... 153.00
 I..... 150.00
 K..... 145.00
 L..... 140.00

"M. M." finish

No. 5261

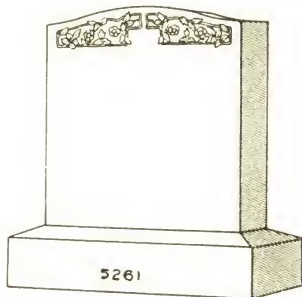

Die.....3. 0 x 1.0 x 3.0 .9.0
 B. Base.....3.10 x 1.8 x 1.0 .6.5
 Weight complete 2600 lbs.; no B. B. 1500 lbs.

D.....	\$146.00
F.....	138.00
G.....	133.00
H.....	129.00
I.....	124.00
K.....	117.00
L.....	111.00

If B. B. is omitted deduct \$22.45

No. 5262

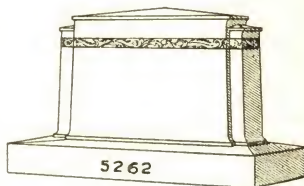

Die.....5.0 x 1.4 x 3.4 .22.3
 B. Ba. (S.S.) .6.4 x 2.4 x 1.0 .14.9
 Weight complete 6600 lbs.

D.....	\$643.00
F.....	621.00
G.....	610.00
H.....	599.00
I.....	588.00
K.....	571.00
L.....	554.00

"M. M." finish

No. 5261¹/₄

Die.....2.8 x 0.10 x 2.8 .5.11
 B. Base....3.6 x 1.6 x 1.0 .5.3
 Weight complete 1900 lbs.; no B. B. 955 lbs.

D.....	\$104.00
F.....	98.00
G.....	95.00
H.....	92.00
I.....	89.00
K.....	85.00
L.....	80.00

If B. B. is omitted deduct \$18.40

No. 5262¹/₄

Die.....5.0 x 1.2 x 3.4 .19.5
 B. Ba. (S.S.) .6.4 x 2.2 x 1.0 .13.9
 Weight complete 5900 lbs.

D.....	\$596.00
F.....	576.00
G.....	567.00
H.....	557.00
I.....	547.00
K.....	533.00
L.....	518.00

"M. M." finish

No. 5261¹/₂

Die.....2.4 x 0.8 x 2.4 .3.8
 B. Base.....3.2 x 1.4 x 1.0 .4.3
 Weight complete 1275 lbs.; no B. B. 510 lbs.

D.....	\$72.00
F.....	68.00
G.....	66.50
H.....	64.50
I.....	62.50
K.....	60.00
L.....	57.00

If B. B. is omitted deduct \$14.90

No. 5262¹/₂

Die.....4.2 x 1.0 x 2.10 .11.10
 B. Ba. (S.S.) .5.4 x 1.10 x 0.10 .8.2
 Weight complete 3600 lbs.

D.....	\$451.00
F.....	439.00
G.....	433.00
H.....	427.00
I.....	421.00
K.....	412.00
L.....	404.00

"M. M." finish

No. 5263

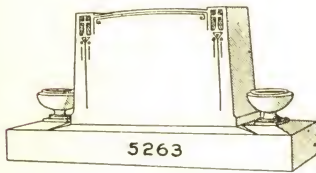

2 Vases.....1.4 x 1.4 x 1.0.. 1.9
 Die.....4.2 x 1.2 x 2.6.. 12.2
 B. Ba. (S.S.)..7.4 x 2.0 x 1.0.. 14.8
 Weight complete 5100 lbs.

D.....	\$399.00
F.....	386.00
G.....	380.00
H.....	374.00
I.....	368.00
K.....	359.00
L.....	349.00

"M. M." finish

No. 5263¹/₄

2 Vases.....1.2 x 1.2 x 0.10.. 1.2
 Die.....4.0 x 1.0 x 2.4.. 9.4
 B. Ba. (S.S.)..6.10 x 1.10 x 1.0.. 12.6
 Weight complete 4100 lbs.

D.....	\$324.00
F.....	314.00
G.....	310.00
H.....	305.00
I.....	300.00
K.....	293.00
L.....	286.00

"M. M." finish

No. 5263¹/₂

2 Vases.....1.0 x 1.0 x 0.8.. 0.8
 Die.....3.8 x 0.10 x 2.2.. 6.7
 B. Ba. (S.S.)..6.2 x 1.6 x 0.10.. 7.9
 Weight complete 2500 lbs.

D.....	\$248.00
F.....	242.00
G.....	238.00
H.....	235.00
I.....	232.00
K.....	227.00
L.....	222.00

"M. M." finish

No. 5264

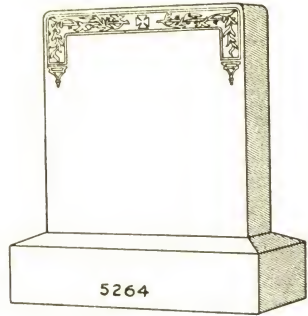

Die.....2.6 x 1.0 x 2.8.. 6.8
 B. Base.....3.2 x 1.6 x 1.0.. 4.9
 Weight complete 2000 lbs.; no B. B. 1150 lbs.

D.....	\$100.00
F.....	93.50
G.....	90.50
H.....	87.00
I.....	83.50
K.....	78.50
L.....	73.50

If B. B. is omitted deduct \$16.65

No. 5264¹/₄

Die.....2.4 x 0.10 x 2.6.. 4.10
 B. Base.....3.0 x 1.4 x 1.0.. 4.0
 Weight complete 1550 lbs.; no B. B. 830 lbs.

D.....	\$76.50
F.....	71.50
G.....	69.00
H.....	67.00
I.....	64.50
K.....	60.50
L.....	57.00

If B. B. is omitted deduct \$14.00

No. 5264¹/₂

Die.....2.2 x 0.8 x 2.4.. 3.4
 B. Base.....2.10 x 1.2 x 0.10.. 2.9
 Weight complete 1075 lbs.; no B. B. 575 lbs.

D.....	\$54.50
F.....	51.50
G.....	49.75
H.....	48.00
I.....	46.25
K.....	43.75
L.....	41.25

If B. B. is omitted deduct \$9.90

No. 5265

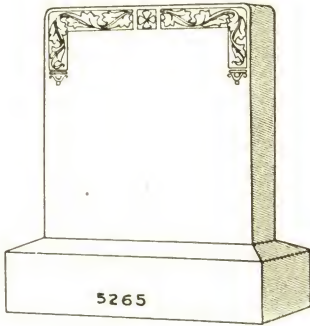

Die.....2.6 x 1.0 x 2.8..6.8
 B. Base.....3.2 x 1.6 x 1.0..4.9
 Weight complete 2000 lbs.; no B. B. 1150 lbs.

D.....	\$101.00
F.....	93.50
G.....	90.50
H.....	87.00
I.....	83.50
K.....	78.50
L.....	73.50

If B. B. is omitted deduct \$16.65

No. 5266

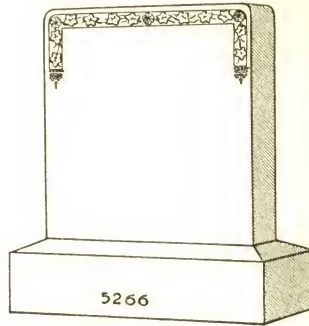

Die.....2.6 x 1.0 x 2.8..6.8
 B. Base.....3.2 x 1.6 x 1.0..4.9
 Weight complete 2000 lbs.; no B. B. 1150 lbs.

D.....	\$101.00
F.....	93.50
G.....	90.50
H.....	87.00
I.....	83.50
K.....	78.50
L.....	73.50

If B. B. is omitted deduct \$16.65

No. 5265¹/₄

Die.....2.4 x 0.10 x 2.6..4.10
 B. Base.....3.0 x 1.4 x 1.0..4.0
 Weight complete 1550 lbs.; no B. B. 830 lbs.

D.....	\$76.50
F.....	71.50
G.....	69.00
H.....	67.00
I.....	64.50
K.....	60.50
L.....	57.00

If B. B. is omitted deduct \$14.00

No. 5266¹/₄

Die.....2.4 x 0.10 x 2.6..4.10
 B. Base.....3.0 x 1.4 x 1.0..4.0
 Weight complete 1550 lbs.; no B. B. 830 lbs.

D.....	\$76.50
F.....	71.50
G.....	69.00
H.....	67.00
I.....	64.50
K.....	60.50
L.....	57.00

If B. B. is omitted deduct \$14.00

No. 5265¹/₂

Die.....2.2 x 0.8 x 2.4..3.4
 B. Base.....2.10 x 1.2 x 0.10..2.9
 Weight complete 1075 lbs.; no B. B. 575 lbs.

D.....	\$54.50
F.....	51.50
G.....	49.75
H.....	48.00
I.....	46.25
K.....	43.75
L.....	41.25

If B. B. is omitted deduct \$9.90

No. 5266¹/₂

Die.....2.2 x 0.8 x 2.4..3.4
 B. Base.....2.10 x 1.2 x 0.10..2.9
 Weight complete 1075 lbs.; no B. B. 575 lbs.

D.....	\$54.50
F.....	51.50
G.....	49.75
H.....	48.00
I.....	46.25
K.....	43.75
L.....	41.25

If B. B. is omitted deduct \$9.90

No. 5267

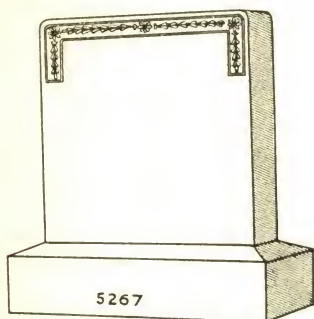

Die.....2.6 x 1.0 x 2.8..6.8
 B. Base.....3.2 x 1.6 x 1.0..4.9
 Weight complete 2000 lbs.; no B.B.1150 lbs.

D.....\$101.00
 F.....93.50
 G.....90.50
 H.....87.00
 I.....83.50
 K.....78.50
 L.....73.50

If B. B. is omitted deduct \$16.65

No. 5267¹/₄

Die.....2.4 x 0.10 x 2.6..4.10
 B. Base.....3.0 x 1.4 x 1.0..4.0
 Weight complete 1550 lbs.; no B. B. 830 lbs.

D.....\$76.50
 F.....71.50
 G.....69.00
 H.....67.00
 I.....64.50
 K.....60.50
 L.....57.00

If B. B. is omitted deduct \$14.00

No. 5267¹/₂

Die.....2.2 x 0.8 x 2.4..3.4
 B. Base.....2.10 x 1.2 x 0.10..2.9
 Weight complete 1075 lbs.; no B. B. 575 lbs.

D.....\$54.50
 F.....51.50
 G.....49.75
 H.....48.00
 I.....46.25
 K.....43.75
 L.....41.25

If B. B. is omitted deduct \$9.90

No. 5268

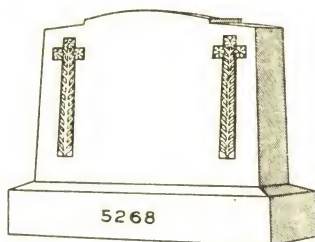

Die.....4.0 x 1.2 x 3.0..14.0
 B. Ba. (S.S.)..5.0 x 2.0 x 1.2..11.8
 Weight complete 4500 lbs.

D.....\$332.00
 F.....318.00
 G.....311.00
 H.....304.00
 I.....297.00
 K.....287.00
 L.....276.00

"M. M." finish

No. 5268¹/₄

Die.....3.6 x 1.0 x 2.8..9.4
 B. Ba. (S.S.)..4.6 x 1.10 x 1.0..8.3
 Weight complete 3000 lbs.

D.....\$255.00
 F.....245.00
 G.....241.00
 H.....236.00
 I.....231.00
 K.....224.00
 L.....217.00

"M. M." finish

No. 5268¹/₂

Die.....3.6 x 0.10 x 2.8..7.9
 B. Ba. (S.S.)..4.6 x 1.8 x 1.0..7.6
 Weight complete 2650 lbs.

D.....\$229.00
 F.....221.00
 G.....217.00
 H.....213.00
 I.....210.00
 K.....204.00
 L.....198.00

"M. M." finish

No. 5268³/₄

Die.....3.6 x 0.8 x 2.8..6.3
 B. Ba. (S.S.)..4.6 x 1.6 x 1.0..6.9
 Weight complete 2275 lbs.

D.....\$208.00
 F.....202.00
 G.....199.00
 H.....196.00
 I.....193.00
 K.....188.00
 L.....183.00

"M. M." finish

No. 5269

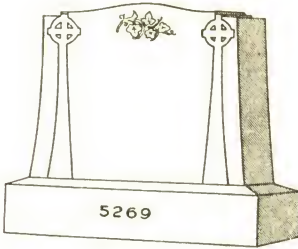

Die.....4.0 x 1.2 x 3.0..14.0
 B. Ba. (S.S.)..5.0 x 2.0 x 1.2..11.8
 Weight complete 4600 lbs.

D.....	\$327.00
F.....	313.00
G.....	306.00
H.....	299.00
I.....	292.00
K.....	282.00
L.....	271.00

"M. M." finish

No. 5270

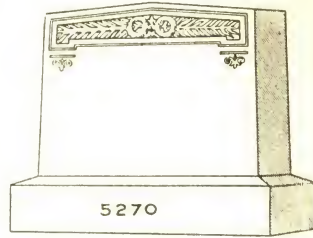

Die.....4.0 x 1.2 x 3.0..14.0
 B. Ba. (S.S.)..5.0 x 2.0 x 1.2..11.8
 Weight complete 4600 lbs.

D.....	\$322.00
F.....	308.00
G.....	301.00
H.....	294.00
I.....	287.00
K.....	277.00
L.....	266.00

"M. M." finish

No. 5269¹/₄

Die.....4.0 x 1.0 x 3.0..12.0
 B. Ba. (S.S.)..5.0 x 1.10 x 1.0..9.2
 Weight complete 3800 lbs.

D.....	\$287.00
F.....	275.00
G.....	269.00
H.....	263.00
I.....	257.00
K.....	248.00
L.....	239.00

"M. M." finish

No. 5270¹/₄

Die.....3.6 x 1.0 x 2.8..9.4
 B. Ba. (S.S.)..4.6 x 1.10 x 1.0..8.3
 Weight complete 3000 lbs.

D.....	\$243.00
F.....	233.00
G.....	229.00
H.....	224.00
I.....	219.00
K.....	212.00
L.....	205.00

"M. M." finish

No. 5269¹/₂

Die.....4.0 x 0.10 x 3.0..10.0
 B. Ba. (S.S.)..5.0 x 1.8 x 1.0..8.4
 Weight complete 3300 lbs.

D.....	\$256.00
F.....	246.00
G.....	241.00
H.....	236.00
I.....	231.00
K.....	224.00
L.....	216.00

"M. M." finish

No. 5270¹/₂

Die.....3.6 x 0.10 x 2.8..7.9
 B. Ba. (S.S.)..4.6 x 1.8 x 1.0..7.6
 Weight complete 2725 lbs.

D.....	\$217.00
F.....	209.00
G.....	205.00
H.....	201.00
I.....	198.00
K.....	192.00
L.....	186.00

"M. M." finish

No. 5269³/₄

Die.....4.0 x 0.8 x 3.0..8.0
 B. Ba. (S.S.)..5.0 x 1.6 x 1.0..7.6
 Weight complete 2775 lbs.

D.....	\$225.00
F.....	217.00
G.....	213.00
H.....	209.00
I.....	205.00
K.....	199.00
L.....	193.00

"M. M." finish

No. 5270³/₄

Die.....3.6 x 0.8 x 2.8..6.3
 B. Ba. (S.S.)..4.6 x 1.6 x 1.0..6.9
 Weight complete 2300 lbs.

D.....	\$194.00
F.....	188.00
G.....	185.00
H.....	182.00
I.....	179.00
K.....	174.00
L.....	169.00

"M. M." finish

No. 5271

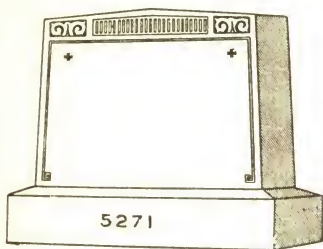

Die.....	4.0 x 1.2 x 3.0..	14.0
B. Ba. (S.S.)..	5.0 x 2.0 x 1.2..	11.8
Weight complete 4500 lbs.		
D.....		\$299.00
F.....		285.00
G.....		278.00
H.....		271.00
I.....		264.00
K.....		254.00
L.....		243.00
"M. M." finish		

No. 5271¹/₄

Die.....	3.6 x 1.0 x 2.8..	9.4
B. Ba. (S.S.)..	4.6 x 1.10 x 1.0..	8.3
Weight complete 3000 lbs.		
D.....		\$222.00
F.....		212.00
G.....		208.00
H.....		203.00
I.....		198.00
K.....		191.00
L.....		184.00
"M. M." finish		

No. 5271¹/₂

Die.....	3.6 x 0.10 x 2.8..	7.9
B. Ba. (S.S.)..	4.6 x 1.8 x 1.0..	7.6
Weight complete 2725 lbs.		
D.....		\$196.00
F.....		188.00
G.....		184.00
H.....		180.00
I.....		177.00
K.....		171.00
L.....		165.00
"M. M." finish		

No. 5271³/₄

Die.....	3.6 x 0.8 x 2.8..	6.3
B. Ba. (S.S.)..	4.6 x 1.6 x 1.0..	6.9
Weight complete 2300 lbs.		
D.....		\$173.00
F.....		167.00
G.....		164.00
H.....		161.00
I.....		158.00
K.....		153.00
L.....		148.00
"M. M." finish		

No. 5272



Die.....	4.0 x 1.2 x 3.0..	14.0
B. Ba. (S.S.)..	5.0 x 2.0 x 1.2..	11.8
Weight complete 4500 lbs.		
D.....		\$289.00
F.....		275.00
G.....		268.00
H.....		261.00
I.....		254.00
K.....		244.00
L.....		233.00
"M. M." finish		

No. 5272¹/₄

Die.....	3.6 x 1.0 x 2.8..	9.4
B. Ba. (S.S.)..	4.6 x 1.10 x 1.0..	8.3
Weight complete 3000 lbs.		
D.....		\$213.00
F.....		203.00
G.....		199.00
H.....		194.00
I.....		189.00
K.....		182.00
L.....		175.00
"M. M." finish		

No. 5272¹/₂

Die.....	3.6 x 0.10 x 2.8..	7.9
B. Ba. (S.S.)..	4.6 x 1.8 x 1.0..	7.6
Weight complete 2725 lbs.		
D.....		\$187.00
F.....		179.00
G.....		175.00
H.....		171.00
I.....		168.00
K.....		162.00
L.....		156.00
"M. M." finish		

No. 5272³/₄

Die.....	3.6 x 0.8 x 2.8..	6.3
B. Ba. (S.S.)..	4.6 x 1.6 x 1.0..	6.9
Weight complete 2300 lbs.		
D.....		\$163.00
F.....		157.00
G.....		154.00
H.....		151.00
I.....		148.00
K.....		143.00
L.....		138.00
"M. M." finish		

No. 5273

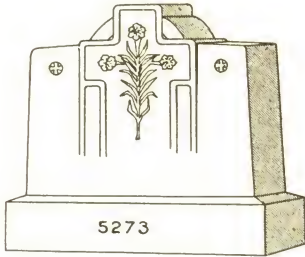

Die..... 4.6 x 1.2 x 3.10.. 20. 2
 B. Ba. (S.S.) .5.6 x 2.0 x 1. 2.. 12.10
 Weight complete 5800 lbs.

D.....	\$410.00
F.....	390.00
G.....	380.00
H.....	370.00
I.....	360.00
K.....	345.00
L.....	329.00

"M. M." finish

No. 5273¹/₄

Die..... 4.4 x 1. 0 x 3.8.. 15.11
 B. Ba. (S.S.) .5.4 x 1.10 x 1.0.. 9. 9
 Weight complete 4500 lbs.

D.....	\$338.00
F.....	322.00
G.....	314.00
H.....	306.00
I.....	298.00
K.....	286.00
L.....	274.00

"M. M." finish

No. 5273¹/₂

Die..... 4.0 x 0.10 x 3.4.. 11.1
 B. Ba. (S.S.) .5.0 x 1. 8 x 1.0.. 8.4
 Weight complete 3400 lbs.

D.....	\$284.00
F.....	272.00
G.....	267.00
H.....	261.00
I.....	256.00
K.....	248.00
L.....	239.00

"M. M." finish

No. 5273³/₄

Die..... 4. 0 x 0.8 x 3.4.. 8.11
 B. Ba. (S.S.) .4. 10 x 1.4 x 1.0.. 6. 5
 Weight complete 2675 lbs.

D.....	\$244.00
F.....	236.00
G.....	231.00
H.....	227.00
I.....	222.00
K.....	217.00
L.....	209.00

"M. M." finish

No. 5274

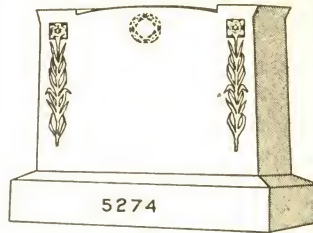

Die..... 4.0 x 1.2 x 3.0.. 14.0
 B. Ba. (S.S.) .5.0 x 2.0 x 1. 2.. 11.8
 Weight complete 4500 lbs.

D.....	\$294.00
F.....	280.00
G.....	273.00
H.....	266.00
I.....	259.00
K.....	249.00
L.....	238.00

"M. M." finish

No. 5274¹/₄

Die..... 3.8 x 1. 0 x 2.8.. 9.9
 B. Ba. (S.S.) .4.8 x 1.10 x 1.0.. 8.7
 Weight complete 3100 lbs.

D.....	\$223.00
F.....	213.00
G.....	208.00
H.....	203.00
I.....	199.00
K.....	191.00
L.....	184.00

"M. M." finish

No. 5274¹/₂

Die..... 3.8 x 0.10 x 2.8.. 8.2
 B. Ba. (S.S.) .4.8 x 1. 8 x 1.0.. 7.9
 Weight complete 2775 lbs.

D.....	\$198.00
F.....	190.00
G.....	186.00
H.....	182.00
I.....	178.00
K.....	172.00
L.....	165.00

"M. M." finish

No. 5274³/₄

Die..... 3.8 x 0.8 x 2.8.. 6.6
 B. Ba. (S.S.) .4.8 x 1.6 x 1.0.. 7.0
 Weight complete 2350 lbs.

D.....	\$172.00
F.....	166.00
G.....	163.00
H.....	159.00
I.....	156.00
K.....	151.00
L.....	146.00

"M. M." finish

No. 5275

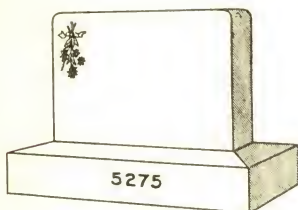

Die.....	2.0 x 0.8 x 1.6	2.0
B. Base.....	2.8 x 1.2 x 0.10	2.7
Weight complete 825 lbs.; no B. B. 360 lbs.		
D.....		\$46.00
F.....		44.00
G.....		43.00
H.....		42.00
I.....		41.00
K.....		39.50
L.....		38.00
If B. B. is omitted deduct \$9.39		

No. 5275¹/₄

Die.....	2.0 x 0.6 x 1.6	1.6
B. Base.....	2.8 x 1.0 x 0.10	2.3
Weight complete 675 lbs.; no B. B. 270 lbs.		
D.....		\$37.75
F.....		36.25
G.....		35.50
H.....		34.75
I.....		34.00
K.....		32.75
L.....		31.75
If B. B. is omitted deduct \$8.10		

No. 5275¹/₂

Die.....	1.8 x 0.4 x 1.4	0.9
B. Base.....	2.2 x 0.8 x 0.8	1.0
Weight complete 315 lbs.; no B. B. 135 lbs.		
D.....		\$20.00
F.....		19.00
G.....		18.75
H.....		18.25
I.....		18.00
K.....		17.50
L.....		16.75
If B. B. is omitted deduct \$3.75		

No. 5276

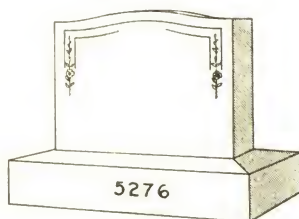

Die.....	4.0 x 1.2 x 3.0	14.0
B. Ba. (S.S.).....	5.0 x 2.0 x 1.2	11.8
Weight complete 4600 lbs.		
D.....		\$260.00
F.....		246.00
G.....		239.00
H.....		232.00
I.....		225.00
K.....		215.00
L.....		204.00
"M. M." finish		

No. 5276¹/₄

Die.....	3.6 x 1.0 x 2.8	9.4
B. Ba. (S.S.).....	4.6 x 1.10 x 1.0	8.3
Weight complete 3100 lbs.		
D.....		\$184.00
F.....		174.00
G.....		170.00
H.....		165.00
I.....		160.00
K.....		153.00
L.....		146.00
"M. M." finish		

No. 5276¹/₂

Die.....	3.6 x 0.10 x 2.8	7.9
B. Ba. (S.S.).....	4.6 x 1.8 x 1.0	7.6
Weight complete 2700 lbs.		
D.....		\$158.00
F.....		150.00
G.....		146.00
H.....		142.00
I.....		139.00
K.....		133.00
L.....		127.00
"M. M." finish		

No. 5276³/₄

Die.....	3.6 x 0.8 x 2.8	6.3
B. Ba. (S.S.).....	4.6 x 1.6 x 1.0	6.9
Weight complete 2300 lbs.		
D.....		\$134.00
F.....		128.00
G.....		125.00
H.....		122.00
I.....		119.00
K.....		114.00
L.....		109.00
"M. M." finish		

No. 5277

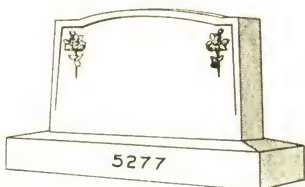

Die.....4.2 x 1.2 x 2.8..13.0
 B. Ba. (S.S.)..5.2 x 2.0 x 1.0..10.4
 Weight complete 4200 lbs.

D.....	\$293.00
F.....	281.00
G.....	274.00
H.....	268.00
I.....	261.00
K.....	251.00
L.....	242.00

"M. M." finish

No. 5278

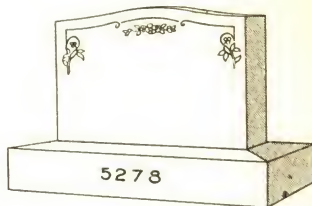

Die.....2.6 x 0.10 x 2. 0. 4.2
 B. Ba. (S.S.)..3.0 x 1. 4 x 0.10..3.4
 Weight complete 1300 lbs.

D.....	\$86.00
F.....	82.00
G.....	80.00
H.....	78.00
I.....	75.50
K.....	72.50
L.....	69.50

"M. M." finish

No. 5277¹/₄

Die.....3.10 x 1. 0 x 2. 6..9.7
 B. Ba. (S.S.)..4.10 x 1. 10 x 0.10..7.5
 Weight complete 2900 lbs.

D.....	\$238.00
F.....	228.00
G.....	223.00
H.....	219.00
I.....	214.00
K.....	207.00
L.....	199.00

"M. M." finish

No. 5278¹/₄

Die.....2.6 x 0.8 x 2. 0..3. 4
 B. Ba. (S.S.)..3.0 x 1.2 x 0.10..2.11
 Weight complete 1100 lbs.

D.....	\$72.50
F.....	69.50
G.....	67.50
H.....	66.00
I.....	64.50
K.....	62.00
L.....	59.50

"M. M." finish

No. 5277¹/₂

Die.....3.10 x 0.10 x 2. 6..8.0
 B. Ba. (S.S.)..4.10 x 1. 8 x 0.10..6.9
 Weight complete 2600 lbs.

D.....	\$215.00
F.....	207.00
G.....	203.00
H.....	199.00
I.....	195.00
K.....	189.00
L.....	183.00

"M. M." finish

No. 5278¹/₂

Die.....2.6 x 0.6 x 2. 0..2.6
 B. Ba. (S.S.)..3.0 x 1.0 x 0.10..2.6
 Weight complete 900 lbs.

D.....	\$59.00
F.....	57.00
G.....	55.50
H.....	54.50
I.....	53.00
K.....	51.00
L.....	49.50

"M. M." finish

No. 5279

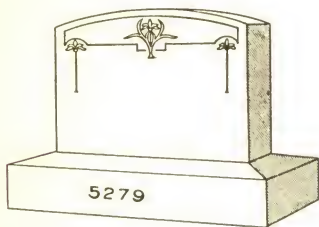

Die.....2.6 x 0.10 x 2. 0. 4.2
 B. Ba. (S.S.) .3.0 x 1. 4 x 0.10. .3.4

Weight complete 1300 lbs.

D.....	\$82.00
F.....	78.00
G.....	76.00
H.....	74.00
I.....	71.50
K.....	68.50
L.....	65.50

"M. M." finish

No. 5279¹/₄

Die.....2.6 x 0.8 x 2. 0. 3. 4
 B. Ba. (S.S.) .3.0 x 1.2 x 0.10. .2.11

Weight complete 1100 lbs.

D.....	\$69.50
F.....	66.50
G.....	64.50
H.....	63.00
I.....	61.50
K.....	59.00
L.....	56.50

"M. M." finish

No. 5279¹/₂

Die.....2.6 x 0.6 x 2. 0. 2.6
 B. Ba. (S.S.) .3.0 x 1.0 x 0.10. .2.6

Weight complete 900 lbs.

D.....	\$56.00
F.....	54.00
G.....	52.50
H.....	51.50
I.....	50.00
K.....	48.00
L.....	46.50

"M. M." finish

No. 5280

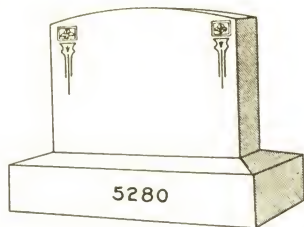

Die.....4.0 x 1.2 x 3.0. 14.0
 B. Ba. (S.S.) .5.0 x 2.0 x 1.2. 11.8

Weight complete 4600 lbs.

D.....	\$277.00
F.....	263.00
G.....	256.00
H.....	249.00
I.....	242.00
K.....	232.00
L.....	221.00

"M. M." finish

No. 5280¹/₄

Die.....3.6 x 1. 0 x 2.8. 9.4
 B. Ba. (S.S.) .4.6 x 1.10 x 1.0. 8.3

Weight complete 3100 lbs.

D.....	\$207.00
F.....	197.00
G.....	193.00
H.....	188.00
I.....	183.00
K.....	176.00
L.....	169.00

"M. M." finish

No. 5280¹/₂

Die.....3.6 x 0.10 x 2.8. 7.9
 B. Ba. (S.S.) .4.6 x 1. 8 x 1.0. 7.6

Weight complete 2700 lbs.

D.....	\$180.00
F.....	172.00
G.....	168.00
H.....	164.00
I.....	161.00
K.....	155.00
L.....	149.00

"M. M." finish

No. 5280³/₄

Die.....3.6 x 0.8 x 2.8. 6.3
 B. Ba. (S.S.) .4.6 x 1.6 x 1.0. 6.9

Weight complete 2300 lbs.

D.....	\$157.00
F.....	151.00
G.....	148.00
H.....	145.00
I.....	142.00
K.....	137.00
L.....	132.00

"M. M." finish

No. 5281

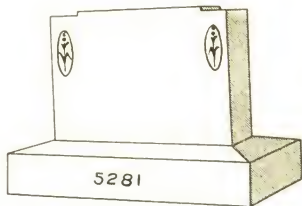

Die.....4.0 x 1.2 x 3.0..14.0
 B. Ba. (S.S.)..5.0 x 2.0 x 1.0..10.0

Weight complete 4300 lbs.

D.....\$241.00
 F.....227.00
 G.....220.00
 H.....213.00
 I.....206.00
 K.....196.00
 L.....185.00

"M. M." finish

No. 5282

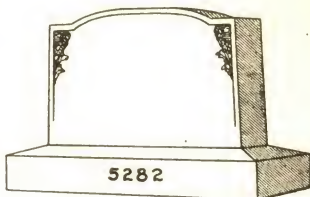

Die.....4.0 x 1.2 x 3.0..14.0
 B. Ba. (S.S.)..5.0 x 2.0 x 1.2..11.8

Weight complete 4500 lbs.

D.....\$282.00
 F.....268.00
 G.....261.00
 H.....254.00
 I.....247.00
 K.....236.00
 L.....226.00

"M. M." finish

No. 5281¹/₄

Die.....3.6 x 1.0 x 2.8..9.4
 B. Ba. (S.S.)..4.6 x 1.10 x 1.0..8.3

Weight complete 3100 lbs.

D.....\$175.00
 F.....165.00
 G.....161.00
 H.....156.00
 I.....151.00
 K.....144.00
 L.....137.00

"M. M." finish

No. 5282¹/₄

Die.....3.6 x 1.0 x 2.8..9.4
 B. Ba. (S.S.)..4.6 x 1.10 x 1.0..8.3

Weight complete 3100 lbs.

D.....\$209.00
 F.....199.00
 G.....195.00
 H.....190.00
 I.....185.00
 K.....178.00
 L.....171.00

"M. M." finish

No. 5281¹/₂

Die.....3.6 x 0.10 x 2.8..7.9
 B. Ba. (S.S.)..4.6 x 1.8 x 1.0..7.6

Weight complete 2700 lbs.

D.....\$150.00
 F.....142.00
 G.....138.00
 H.....134.00
 I.....131.00
 K.....125.00
 L.....119.00

"M. M." finish

No. 5282¹/₂

Die.....3.6 x 0.10 x 2.8..7.9
 B. Ba. (S.S.)..4.6 x 1.8 x 1.0..7.6

Weight complete 2700 lbs.

D.....\$189.00
 F.....181.00
 G.....177.00
 H.....173.00
 I.....169.00
 K.....164.00
 L.....158.00

"M. M." finish

No. 5281³/₄

Die.....3.6 x 0.8 x 2.8..6.3
 B. Ba. (S.S.)..4.6 x 1.4 x 1.0..6.0

Weight complete 2200 lbs.

D.....\$123.00
 F.....117.00
 G.....114.00
 H.....111.00
 I.....108.00
 K.....103.00
 L.....98.00

"M. M." finish

No. 5282³/₄

Die.....3.6 x 0.8 x 2.8..6.3
 B. Ba. (S.S.)..4.6 x 1.6 x 1.0..6.9

Weight complete 2300 lbs.

D.....\$166.00
 F.....160.00
 G.....157.00
 H.....154.00
 I.....150.00
 K.....146.00
 L.....141.00

"M. M." finish

No. 5283

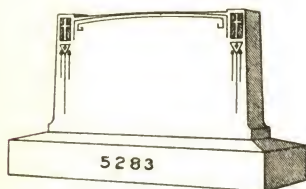

Die.....4.4 x 1.2 x 2.6..12.8
 B.Ba. (S.S.)..5.4 x 2.0 x 1.0..10.8
 Weight complete 4000 lbs.

D.....	\$301.00
F.....	289.00
G.....	282.00
H.....	276.00
I.....	270.00
K.....	260.00
L.....	251.00

"M. M." finish

No. 5284

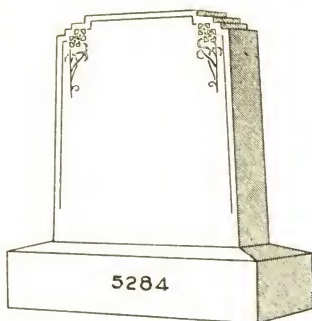

Die.....3.0 x 1.0 x 3.8..11.0
 B.Ba. (S.S.)..4.0 x 1.10 x 1.0..7.4
 Weight complete 3100 lbs.

D.....	\$210.00
F.....	200.00
G.....	194.00
H.....	189.00
I.....	183.00
K.....	175.00
L.....	167.00

"M. M." finish

No. 5283¹/₄

Die.....4.0 x 1.0 x 2.4..9.4
 B.Ba. (S.S.)..5.0 x 1.10 x 0.10..7.8
 Weight complete 2900 lbs.

D.....	\$243.00
F.....	233.00
G.....	229.00
H.....	224.00
I.....	219.00
K.....	212.00
L.....	205.00

"M. M." finish

No. 5284¹/₄

Die.....2.6 x 0.10 x 3.0..6.3
 B.Ba. (S.S.)..3.6 x 1.8 x 1.0..5.10
 Weight complete 2100 lbs.

D.....	\$143.00
F.....	137.00
G.....	134.00
H.....	131.00
I.....	128.00
K.....	123.00
L.....	118.00

"M. M." finish

No. 5283¹/₂

Die.....3.8 x 0.10 x 2.2..6.7
 B.Ba. (S.S.)..4.8 x 1.8 x 0.10..6.6
 Weight complete 2250 lbs.

D.....	\$200.00
F.....	194.00
G.....	190.00
H.....	187.00
I.....	184.00
K.....	179.00
L.....	174.00

"M. M." finish

No. 5284¹/₂

Die.....2.6 x 0.8 x 3.0..5.0
 B. Ba. (S.S.)..3.6 x 1.4 x 1.0..4.8
 Weight complete 1700 lbs.

D.....	\$119.00
F.....	115.00
G.....	112.00
H.....	110.00
I.....	107.00
K.....	103.00
L.....	100.00

"M. M." finish

No. 5285

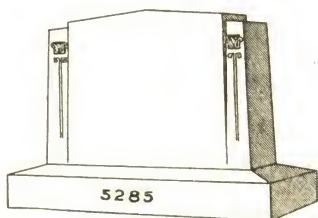

Die.....4.0 x 1.2 x 3. 0..14.0
 B.Ba. (S.S.) .5.0 x 2.0 x 0.10.. 8.4
 Weight complete 4000 lbs.

D.....	\$278.00
F.....	264.00
G.....	257.00
H.....	250.00
I.....	243.00
K.....	233.00
L.....	222.00

"M. M." finish

No. 5286

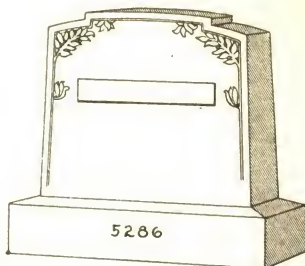

Die.....3. 0 x 1.0 x 2. 8..8.0
 B.Ba. (S.S.) .3.10 x 1.8 x 0.10..5.4
 Weight complete 2200 lbs.

D.....	\$212.00
F.....	204.00
G.....	200.00
H.....	196.00
I.....	192.00
K.....	186.00
L.....	180.00

"M. M." finish

No. 5285¹/₄

Die.....3.6 x 1. 0 x 2. 6..8. 9
 B.Ba. (S.S.) .4.6 x 1.10 x 0.10..6.11
 Weight complete 2800 lbs.

D.....	\$206.00
F.....	198.00
G.....	193.00
H.....	189.00
I.....	185.00
K.....	178.00
L.....	171.00

"M. M." finish

No. 5286¹/₄

Die.....3. 0 x 0.10 x 2. 8..6. 8
 B.Ba. (S.S.) .3.10 x 1. 6 x 0.10..4.10
 Weight complete 1920 lbs.

D.....	193.00
F.....	187.00
G.....	183.00
H.....	180.00
I.....	177.00
K.....	172.00
L.....	167.00

"M. M." finish

No. 5285¹/₂

Die.....3.6 x 0.10 x 2. 6..7.4
 B.Ba. (S.S.) .4.6 x 1. 8 x 0.10..6.3
 Weight complete 2400 lbs.

D.....	\$185.00
F.....	177.00
G.....	174.00
H.....	170.00
I.....	166.00
K.....	161.00
L.....	155.00

"M. M." finish

No. 5286¹/₂

Die.....3. 0 x 0.8 x 2. 8..5.4
 B.Ba. (S.S.) .3.10 x 1.4 x 0.10..4.3
 Weight complete 1625 lbs.

D.....	\$174.00
F.....	168.00
G.....	166.00
H.....	163.00
I.....	160.00
K.....	156.00
L.....	152.00

"M. M." finish

No. 5287

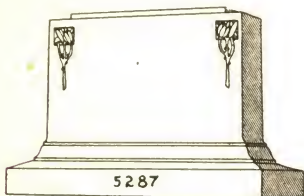

Die.....4.2 x 1.2 x 2.10..13.9
 Base.....4.8 x 1.8 x 0.4..2.7
 B.Ba. (S.S.) .5.8 x 2.8 x 0.10..12.7

Weight complete 4900 lbs.

D.....\$338.00
 F.....322.00
 G.....314.00
 H.....306.00
 I.....297.00
 K.....285.00
 L.....273.00

"M. M." finish

No. 5287¹/₄

Die.....4.0 x 1.0 x 2.8..10.8
 Base.....4.6 x 1.6 x 0.4..2.3
 B.Ba. (S.S.) .5.6 x 2.6 x 0.10..11.6

Weight complete 4150 lbs.

D.....\$290.00
 F.....278.00
 G.....271.00
 H.....265.00
 I.....258.00
 K.....248.00
 L.....239.00

"M. M." finish

No. 5287¹/₂

Die.....3.6 x 0.10 x 2.6..7.4
 Base.....3.11 x 1.1 x 0.4..1.8
 B.Ba. (S.S.) .4.9 x 2.1 x 0.10..8.3

Weight complete 2900 lbs.

D.....\$226.00
 F.....218.00
 G.....213.00
 H.....209.00
 I.....204.00
 K.....197.00
 L.....191.00

"M. M." finish

No. 5287³/₄

Die.....3.6 x 0.8 x 2.6..5.10
 Base.....3.11 x 1.1 x 0.4..1.5
 B.Ba. (S.S.) .4.9 x 1.11 x 0.10..7.7

Weight complete 2500 lbs.

D.....\$201.00
 F.....193.00
 G.....190.00
 H.....186.00
 I.....183.00
 K.....177.00
 L.....172.00

"M. M." finish

No. 5288

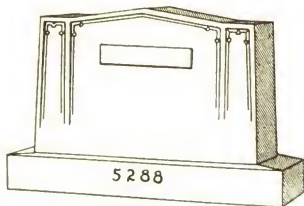

Die.....4.0 x 1.0 x 2.8..10.8
 B.Ba. (S.S.) .5.0 x 1.10 x 0.10..7.8

Weight complete 3100 lbs.

D.....\$220.00
 F.....210.00
 G.....204.00
 H.....199.00
 I.....194.00
 K.....186.00
 L.....178.00

"M. M." finish

No. 5288¹/₄

Die.....4.0 x 0.10 x 2.8..8.11
 B.Ba. (S.S.) .5.0 x 1.8 x 0.10..6.11

Weight complete 2750 lbs.

D.....\$194.00
 F.....186.00
 G.....181.00
 H.....177.00
 I.....172.00
 K.....165.00
 L.....159.00

"M. M." finish

No. 5288¹/₂

Die.....4.0 x 0.8 x 2.8..7.1
 B. Ba. (S.S.) .5.0 x 1.4 x 0.10..5.7

Weight complete 2150 lbs.

D.....\$171.00
 F.....163.00
 G.....160.00
 H.....156.00
 I.....153.00
 K.....148.00
 L.....142.00

"M. M." finish

No. 5289

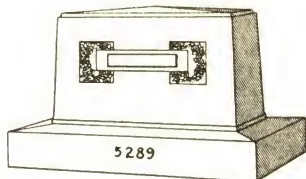

Die.....6. 0 x 2.0 x 3.4..40.0
 B.Ba. (S.S.) .7.10 x 3.6 x 1.0..27.5
 Weight complete 9200 lbs.

- D.....\$815.00
- F..... 775.00
- G..... 755.00
- H..... 735.00
- I..... 715.00
- K..... 685.00
- L..... 655.00

"M. M." finish

No. 5290

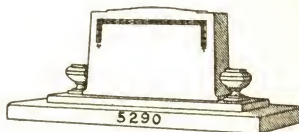

Die.....4. 0 x 1. 2 x 2.10..13.3
 2 Vases.....1. 2 x 1. 2 x 1. 0.. 2.8
 B.Ba. (S.S.) .7.10 x 1.10 x 0.10..12.0
 Weight complete 4100 lbs.

- D.....\$491.00
- F..... 375.00
- G..... 367.00
- H..... 359.00
- I..... 351.00
- K..... 339.00
- L..... 327.00

"M. M." finish

No. 5289¹/₄

Die.....5.6 x 1.8 x 3.0..27.6
 B. Ba. (S.S.) .7.2 x 3.0 x 1.0..21.6
 Weight complete 6600 lbs.

- D.....\$629.00
- F..... 601.00
- G..... 588.00
- H..... 574.00
- I..... 560.00
- K..... 539.00
- L..... 519.00

"M. M." finish

No. 5290¹/₄

Die.....3.8 x 1.0 x 2. 8..9.9
 2 Vases.....1.0 x 1.0 x 0.10..1.8
 B. Ba. (S.S.) .6.6 x 1.8 x 0.10..9.0
 Weight complete 3200 lbs.

- D.....\$312.00
- F..... 300.00
- G..... 295.00
- H..... 289.00
- I..... 283.00
- K..... 275.00
- L..... 266.00

"M. M." finish

No. 5289¹/₂

Die.....5.2 x 1.4 x 3.0..20.8
 B. Ba. (S.S.) .6.8 x 2.6 x 1.0..16.8
 Weight complete 5000 lbs.

- D.....\$510.00
- F..... 490.00
- G..... 479.00
- H..... 469.00
- I..... 459.00
- K..... 443.00
- L..... 428.00

"M. M." finish

No. 5290¹/₂

Die.....3. 8 x 0.10 x 2. 8..8. 2
 2 Vases.....0.10 x 0.10 x 0.10..1. 2
 B.Ba. (S.S.) .6. 4 x 1. 6 x 0.10..7.11
 Weight complete 2700 lbs.

- D.....\$290.00
- F..... 280.00
- G..... 276.00
- H..... 271.00
- I..... 266.00
- K..... 259.00
- L..... 252.00

"M. M." finish

No. 5291

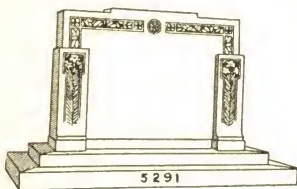

Die.....4.8 x 1.0 x 3. 0..14.0
 B.Ba. (S.S.) 7.0 x 2.8 x 0.10..15.7

Weight complete 4700 lbs.

D.....\$567.00
 F..... 553.00
 G..... 546.00
 H..... 539.00
 I..... 532.00
 K..... 522.00
 L..... 511.00

"M. M." finish

No. 5292



Cap.....8.2 x 2.8 x 1.2..25.5
 Die.....7.0 x 1.8 x 2.2..25.3
 Base.....8.2 x 2.8 x 0.8..14.5
 B. Ba. (S.S.) .9.8 x 4.0 x 1.0..38.8

Weight complete 16600 lbs.

D.....\$1273.00
 F..... 1207.00
 G..... 1175.00
 H..... 1142.00
 I..... 1110.00
 K..... 1061.00
 L..... 1012.00

"M. M." finish

No. 5292¹/₄

Cap.....7.6 x 2.5 x 1.1..19.8
 Die.....6.6 x 1.6 x 2.0..19.6
 Base.....7.6 x 2.5 x 0.6.. 9.1
 B. Ba. (S.S.) .9.0 x 3.8 x 1.0..33.0

Weight complete 12800 lbs.

D.....\$1014.00
 F..... 966.00
 G..... 942.00
 H..... 918.00
 I..... 894.00
 K..... 857.00
 L..... 821.00

"M. M." finish

No. 5291¹/₄

Die.....4.8 x 0.10 x 3. 0..11.8
 B.Ba. (S.S.) 7.0 x 2. 6 x 0.10..14.7

Weight complete 4200 lbs.

D.....\$521.00
 F.....\$509.00
 G..... 503.00
 H..... 498.00
 I..... 492.00
 K..... 483.00
 L..... 474.00

"M. M." finish

No. 5292¹/₂

Cap.....6.10 x 2.1 x 1. 0..14.3
 Die.....6. 0 x 1.4 x 1.10..14.8
 Base.....6.10 x 2.1 x 0. 6.. 7.1
 B.Ba. (S.S.) .8. 2 x 3.2 x 0.10..21.7

Weight complete 9200 lbs.

D.....\$778.00
 F..... 742.00
 G..... 724.00
 H..... 706.00
 I..... 688.00
 K..... 661.00
 L..... 634.00

"M. M." finish

No. 5293

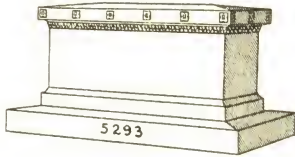

Cap.....7.9 x 2.4 x 0.11..16.7
 Die.....7.0 x 1.8 x 2.6..29.2
 Base.....7.6 x 2.1 x 0.8..10.6
 B.Ba. (S.S.) .9.2 x 3.6 x 1.0..32.2

Weight complete 15000 lbs.

D.....\$1108.00
 F.....1052.00
 G.....1024.00
 H.....996.00
 I.....968.00
 K.....925.00
 L.....883.00

"M. M." finish

No. 5293¹/₄

Cap.....7.4 x 2.2 x 0.10..13.2
 Die.....6.6 x 1.6 x 2.4..22.9
 Base.....7.0 x 1.11 x 0.8..9.0
 B.Ba. (S.S.) .8.6 x 3.2 x 1.0..27.0

Weight complete 12200 lbs.

D.....\$937.00
 F.....893.00
 G.....870.00
 H.....848.00
 I.....825.00
 K.....791.00
 L.....758.00

"M. M." finish

No. 5293¹/₂

Cap.....6.8 x 1.11 x 0.9..9.7
 Die.....6.0 x 1.4 x 2.2..17.4
 Base.....6.5 x 1.8 x 0.6..5.4
 B.Ba. (S.S.) .7.10 x 2.10 x 0.10..18.6

Weight complete 9000 lbs.

D.....\$721.00
 F.....689.00
 G.....673.00
 H.....657.00
 I.....641.00
 K.....616.00
 L.....592.00

"M. M." finish

No. 5294

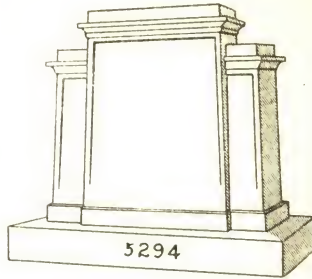

Cap.....3.4 x 1.6¹/₂ x 0.6..2.8
 Die.....5.0 x 1.4 x 4.0..26.8
 B.Ba. (S.S.) .6.2 x 2.0 x 0.8..8.3

Weight complete 6100 lbs.

C.....\$691.00
 D.....625.00
 F.....596.00
 G.....581.00
 H.....566.00
 I.....551.00
 K.....529.00
 L.....507.00

"M. M." finish

No. 5294¹/₄

Cap.....2.10 x 1.4 x 0.5..1.7
 Die.....4.4 x 1.2 x 3.6..17.8
 B.Ba. (S.S.) .5.4 x 1.10 x 0.8..6.6

Weight complete 4250 lbs.

C.....\$524.00
 D.....481.00
 F.....462.00
 G.....452.00
 H.....442.00
 I.....432.00
 K.....418.00
 L.....404.00

"M. M." finish

No. 5294¹/₂

Cap.....2.7 x 1.2 x 0.5..1.3
 Die.....4.0 x 1.0 x 3.4..13.4
 B.Ba. (S.S.) .4.10 x 1.6 x 0.8..4.10

Weight complete 3200 lbs.

C.....\$431.00
 D.....398.00
 F.....383.00
 G.....376.00
 H.....369.00
 I.....362.00
 K.....351.00
 L.....340.00

"M. M." finish

No. 5295

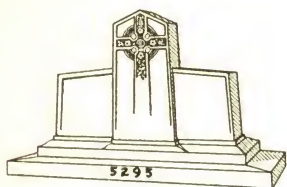

Die..... 2.4x1. 0x4.10..11. 3
 2 Wings..... 2.6x0.10x2. 9..11. 6
 Base..... 8.6x1. 8x0.10..11.10
 B. Ba. (S.S.) . 10.4x2. 8x0. 8..18. 5

Weight complete 9000 lbs.

C.....\$860.00
 D..... 782.00
 F..... 747.00
 G..... 730.00
 H..... 713.00
 I..... 696.00
 K..... 670.00
 L..... 644.00

"M. M." finish

No. 5296

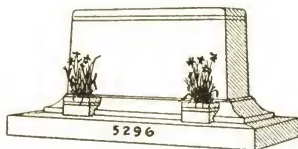

Die.....5.10 x 1.2 x 2. 8..18. 2
 Base..... 7. 2 x 2.2 x 0.10..13. 2
 B. Ba. (S.S.) . 9. 2 x 3.1 x 0. 8..18.10

Weight complete 8600 lbs.

C.....\$739.00
 D..... 668.00
 F..... 637.00
 G..... 621.00
 H..... 605.00
 I..... 589.00
 K..... 565.00
 L..... 541.00

"M. M." finish

No. 5295¹/₄

Die..... 2.4 x 0.10 x 4.10.. 9.5
 2 Wings..... 2.6 x 0. 8 x 2. 9.. 9.2
 Base..... 8.6 x 1. 6 x 0.10..10.8
 B. Ba. (S.S.) . 10.4 x 2. 6 x 0. 8..17.3

Weight complete 6300 lbs.

C.....\$782.00
 D..... 716.00
 F..... 687.00
 G..... 672.00
 H..... 657.00
 I..... 642.00
 K..... 620.00
 L..... 598.00

"M. M." finish

No. 5297¹/₂

Die.....3.0 x 0.8 x 2. 8..5.4
 B. Ba. (S.S.) . 4.0 x 1.6 x 0.10..5.0

Weight complete 1750 lbs.

C.....\$166.00
 D..... 154.00
 F..... 148.00
 G..... 145.00
 H..... 142.00
 I..... 139.00
 K..... 135.00
 L..... 131.00

"M. M." finish

No. 5297

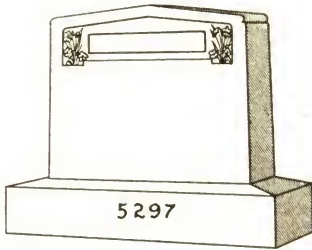

Die.....3.0 x 1.0 x 2.8..8.0
 B.Ba. (S.S.) .4.0 x 1.10 x 0.10..6.1
 Weight complete 2400 lbs.

- C.....\$206.00
- D.....188.00
- F.....180.00
- G.....176.00
- H.....172.00
- I.....168.00
- K.....162.00
- L.....156.00

"M. M." finish

No. 5298

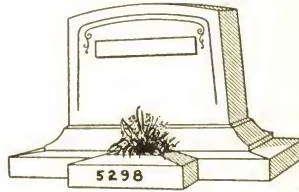

Die.....4.0 x 1.0 x 2.8..10.8
 Base.....5.0 x 1.2 x 0.10..4.10
 B.Ba. (S.S.) .6.8 x 2.8 x 0.8..11.10
 Weight complete 4500 lbs.

- C.....\$417.00
- D.....382.00
- F.....366.00
- G.....358.00
- H.....350.00
- I.....342.00
- K.....330.00
- L.....318.00

"M. M." finish

No. 5298¹/₄

Die.....3.6 x 0.10 x 2.4..6.10
 Base.....4.4 x 1.0 x 0.8..2.11
 B.Ba. (S.S.) .5.8 x 2.6 x 0.6..7.1
 Weight complete 2700 lbs.

- C.....\$300.00
- D.....278.00
- F.....268.00
- G.....263.00
- H.....258.00
- I.....253.00
- K.....246.00
- L.....239.00

"M. M." finish

No. 5297¹/₄

Die.....3.0 x 0.10 x 2.8..6.8
 B.Ba. (S.S.) .4.0 x 1.8 x 0.10..5.7
 Weight complete 2100 lbs.

- C.....\$183.00
- D.....168.00
- F.....162.00
- G.....159.00
- H.....156.00
- I.....153.00
- K.....148.00
- L.....143.00

"M. M." finish

No. 5298¹/₂

Die.....3.6 x 0.8 x 2.4..5.5
 Base.....4.4 x 0.10 x 0.8..2.5
 B. Ba. (S.S.) .5.8 x 2.4 x 0.6..6.7
 Weight complete 2300 lbs.

- C.....\$265.00
- D.....247.00
- F.....239.00
- G.....235.00
- H.....231.00
- I.....227.00
- K.....221.00
- L.....215.00

"M. M." finish

No. 5297¹/₂

See previous column

No. 5299

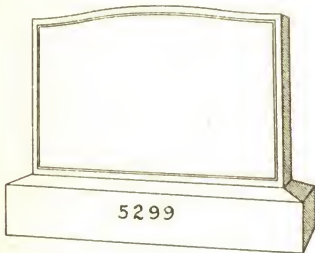

Die.....4.0 x 1.2 x 2.8..12.5
 B. Base.....5.0 x 2.0 x 1.0..10.0
 Weight complete 3925 lbs.; no B.B.1800 lbs.

C.....	\$237.00
D.....	209.00
F.....	197.00
G.....	191.00
H.....	185.00
I.....	179.00
K.....	170.00
L.....	161.00

If B. B. is omitted deduct \$35.00

No. 5299¹/₄

Die.....3.6 x 1.0 x 2.4..8.2
 B. Base....4.6 x 1.10 x 0.10..6.11
 Weight complete 2650 lbs.; no B.B.1245 lbs.

C.....	\$164.00
D.....	146.00
F.....	138.00
G.....	134.00
H.....	130.00
I.....	126.00
K.....	120.00
L.....	114.00

If B. B. is omitted deduct \$24.20

No. 5299¹/₂

Die.....3.6 x 0.10 x 2.4..6.10
 B. Base....4.6 x 1.8 x 0.10..6.3
 Weight complete 2300 lbs.; no B.B.1125 lbs.

C.....	\$141.00
D.....	126.00
F.....	119.00
G.....	116.00
H.....	113.00
I.....	110.00
K.....	105.00
L.....	100.00

If B. B. is omitted deduct \$21.90

No. 5299³/₄

Die.....3.6 x 0.8 x 2.4..5.5
 B. Base....4.6 x 1.6 x 0.10..5.8
 Weight complete 1950 lbs.; no B.B.1020 lbs.

C.....	\$120.00
D.....	108.00
F.....	103.00
G.....	100.00
H.....	97.00
I.....	94.00
K.....	90.00
L.....	86.00

If B. B. is omitted deduct \$19.85

No. 5300

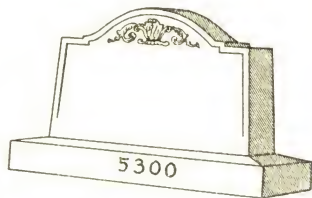

Die.....5.0 x 1.2 x 2.10..16.6
 B.Ba. (S.S.)..6.4 x 2.2 x 0.8..9.2
 Weight complete 4525 lbs.

D.....	\$355.00
F.....	339.00
G.....	331.00
H.....	323.00
I.....	315.00
K.....	303.00
L.....	291.00

"M. M." finish

No. 5300¹/₄

Die.....5.0 x 1.0 x 2.10..14.2
 B.Ba. (S.S.)..6.4 x 2.0 x 0.8..8.5
 Weight complete 4000 lbs.

D.....	\$321.00
F.....	307.00
G.....	300.00
H.....	293.00
I.....	286.00
K.....	275.00
L.....	264.00

"M. M." finish

No. 5300¹/₂

Die.....5.0 x 0.10 x 2.10..11.10
 B.Ba. (S.S.)..6.4 x 1.10 x 0.8..7.9
 Weight complete 3475 lbs.

D.....	\$294.00
F.....	282.00
G.....	276.00
H.....	270.00
I.....	264.00
K.....	255.00
L.....	246.00

"M. M." finish

No. 5301

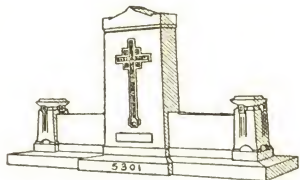

Cap.....	2. 9 x 1.2 x 0.10..	2.8
Die.....	2.10 x 1.2 x 5. 8..	16.0
2 Wings....	4. 1 x 1.2 x 1.10..	17.6
2 Bowls....	1. 7 x 1.7 x 0. 4..	1.8
B. Ba. (S.S.) in three pieces		
1 piece....	4. 4 x 2.9 x 0. 6..	6. 0
2 pieces...	3.11 x 2.6 x 0. 6..	9.10
C.....		\$1083.00
D.....		998.00
F.....		960.00
G.....		941.00
H.....		922.00
I.....		903.00
K.....		875.00
L.....		847.00

"M. M." finish

No. 5302

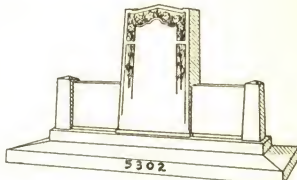

Die.....	3.0 x 0.10 x 5.0..	12.6
2 Wings....	2.6 x 0.10 x 2.0..	8.4
Base.....	8.0 x 1. 0 x 0.4..	2.8
B.Ba. (S.S.)	9.8 x 2. 4 x 0.6..	11.3
C.....		\$664.00
D.....		611.00
F.....		587.00
G.....		575.00
H.....		563.00
I.....		551.00
K.....		533.00
L.....		515.00

"M. M." finish

No. 5301¹/₄

Cap.....	2. 9 x 1.0 x 0.10..	2.4
Die.....	2.10 x 1.0 x 5. 8..	13.8
2 Wings....	4. 1 x 1.0 x 1.10..	15.0
2 Bowls....	1. 5 ¹ / ₂ x 1.5 ¹ / ₂ x 0. 4..	1.6
B. Ba. (S.S.) in three pieces		
1 piece....	4. 2 x 2.7 x 0. 6..	5.5
2 pieces...	3.11 x 2.4 x 0. 6..	9.2
C.....		\$978.00
D.....		905.00
F.....		872.00
G.....		856.00
H.....		840.00
I.....		824.00
K.....		800.00
L.....		776.00

"M. M." finish

No. 5302¹/₄

Die.....	3.0 x 0. 8 x 5.0..	10.0
2 Wings....	2.6 x 0. 8 x 2.0..	6.8
Base.....	8.0 x 0.10 x 0.4..	2.3
B.Ba. (S.S.)	9.8 x 2. 2 x 0.6..	10.6
C.....		\$584.00
D.....		541.00
F.....		522.00
G.....		513.00
H.....		504.00
I.....		495.00
K.....		481.00
L.....		467.00

"M. M." finish

No. 5303



Die.....2. 4 x 0.10 x 2. 0. .3.11
 B. Base...2.10 x 1. 4 x 0.10. .3. 2
 Weight complete 1225 lbs.; no B.B. 685 lbs.

C.....	\$109.00
D.....	100.00
F.....	96.00
G.....	94.00
H.....	92.00
I.....	90.00
K.....	87.00
L.....	84.00

If B. B. is omitted deduct \$11.10

No. 5303 $\frac{1}{4}$

Die.....2. 4 x 0.8 x 2. 0. .3.1
 B. Base...2.10 x 1.2 x 0.10. .2.9
 Weight complete 1000 lbs.; no B.B. 500 lbs.

C.....	\$94.00
D.....	87.00
F.....	84.00
G.....	82.50
H.....	81.00
I.....	79.50
K.....	77.00
L.....	74.50

If B. B is omitted deduct \$9.90

No. 5303 $\frac{1}{2}$

Die.....2. 4 x 0.6 x 2. 0. .2.4
 B. Base...2.10 x 1.0 x 0.10. .2.4
 Weight complete 825 lbs.: no B. B. 405 lbs.

C.....	\$80.50
D.....	75.00
F.....	72.75
G.....	71.50
H.....	70.50
I.....	69.00
K.....	67.00
L.....	65.00

If B. B. is omitted deduct \$8.40

No. 5304

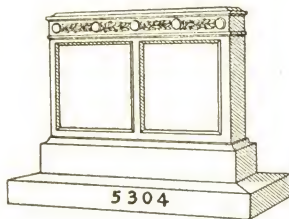

Cap.....5.9 x 1.3 x 0.10. .7 6.0
 Die.....5.6 x 1.0 x 2. 8. .14.8
 Base.....6.0 x 1.6 x 1. 0. . 9.0
 B.Ba. (S.S.) .7.0 x 2.6 x 0. 8. .11.8

Weight complete 7300 lbs.

C.....	\$705.00
D.....	638.00
F.....	608.00
G.....	593.00
H.....	578.00
I.....	563.00
K.....	541.00
L.....	519.00

"M. M." finish

No. 5304 $\frac{1}{4}$

Cap.....4. 8 x 1. 0 x 0. 8. .3.1
 Die.....4. 6 x 0.10 x 2. 4. .8.9
 Base.....4.10 x 1. 2 x 0.10. .4.8
 B.Ba. (S.S.) .5.10 x 2. 2 x 0. 6. .6.4

Weight complete 3900 lbs.

C.....	\$467.00
D.....	430.00
F.....	413.00
G.....	405.00
H.....	397.00
I.....	389.00
K.....	377.00
L.....	365.00

"M. M." finish

No. 5305

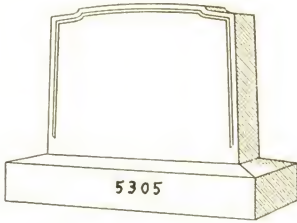

Die.....3.6 x 1. 0 x 3. 0..10. 6
 B.Ba. (S.S.) .4.6 x 1.10 x 0.10.. 6.11

Weight complete 3000 lbs.

- C.....\$218.00
- D.....194.00
- F.....183.00
- G.....178.00
- H.....173.00
- I.....168.00
- K.....160.00
- L.....152.00

"M. M." finish

No. 5305¹/₄

Die.....3.2 x 0.10 x 2.8 ..7.0
 B.Ba. (S.S.) .4.0 x 1. 6 x 0.10..5.0

Weight complete 2150 lbs.

- C.....\$160.00
- D.....144.00
- F.....137.00
- G.....133.00
- H.....129.00
- I.....125.00
- K.....120.00
- L.....115.00

"M. M." finish

No. 5305¹/₂

Die.....3.2 x 0.8 x 2. 8..5.8
 B. Ba. (S.S.) .4.0 x 1. 4 x 0.10..4.5

Weight complete 1775 lbs.

- C.....\$132.00
- D.....119.00
- F.....113.00
- G.....110.00
- H.....107.00
- I.....104.00
- K.....100.00
- L.....96.00

"M. M." finish

No. 5306

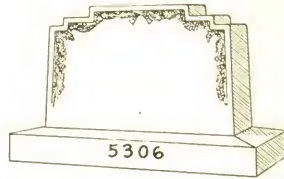

Die.....4.6 x 1.2 x 2.6..13.2
 B. Ba. (S.S.) .5.6 x 2.0..0.8.. 7.4

Weight complete 3500 lbs.

- C.....\$461.00
- D.....431.00
- F.....418.00
- G.....411.00
- H.....404.00
- I.....397.00
- K.....387.00
- L.....377.00

"M. M." finish

No. 5306¹/₄

Die.....4. 0 x 1.0 x 2.4..9.4
 B. Ba. (S.S.) .4.10 x 1. 8 x 0.6..4.0

Weight complete 2250 lbs.

- C.....\$365.00
- D.....344.00
- F.....335.00
- G.....330.00
- H.....325.00
- I.....320.00
- K.....313.00
- L.....306.00

"M. M." finish

No. 5306¹/₂

Die.....4. 0 x 0.10 x 2.4..7.9
 B.Ba. (S.S.) .4.10 x 1. 6 x 0.6..3.8

Weight complete 1900 lbs.

- C.....\$338.00
- D.....321.00
- F.....313.00
- G.....309.00
- H.....305.00
- I.....301.00
- K.....295.00
- L.....289.00

"M. M." finish

No. 5306³/₄

Die.....4. 0 x 0.8 x 2.4..6.3
 B. Ba. (S.S.) .4.10 x 1. 4 x 0.6..3.3

Weight complete 1600 lbs.

- C.....\$311.00
- D.....297.00
- F.....291.00
- G.....288.00
- H.....285.00
- I.....282.00
- K.....277.00
- L.....272.00

"M. M." finish

No. 5307

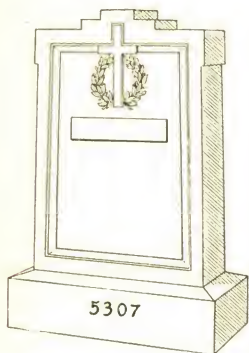

Die.....2.6 x 1.0 x 3.6..8.9
 B. Ba. (S.S.)..3.2 x 1.8 x 0.10..4.5
 Weight complete 2200 lbs.

C.....	\$274.00
D.....	254.00
F.....	245.00
G.....	241.00
H.....	237.00
I.....	233.00
K.....	226.00
L.....	219.00

"M. M." finish

No. 5307¹/₄

Die.....2.6 x 0.10 x 3.6..7.4
 B. Ba. (S.S.)..3.2 x 1.6 x 0.10..4.0
 Weight complete 1900 lbs.

C.....	\$251.00
D.....	234.00
F.....	227.00
G.....	223.00
H.....	219.00
I.....	209.00
K.....	215.00
L.....	203.00

"M. M." finish

No. 5307¹/₂

Die.....2.6 x 0.8 x 3.6..5.10
 B. Ba. (S.S.)..3.2 x 1.4 x 0.10..3.6
 Weight complete 1575 lbs.

C.....	\$223.00
D.....	210.00
F.....	204.00
G.....	201.00
H.....	198.00
I.....	195.00
K.....	191.00
L.....	187.00

"M. M." finish

No. 5308

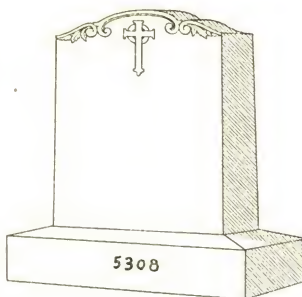

Die.....3.0 x 1.0 x 3.6..10.6
 B. Ba. (S.S.)..4.0 x 1.10 x 0.10..6.1
 Weight complete 2900 lbs.

C.....	\$300.00
D.....	276.00
F.....	265.00
G.....	260.00
H.....	255.00
I.....	250.00
K.....	242.00
L.....	234.00

"M. M." finish

If Cross is omitted deduct \$12.00

No. 5308¹/₄

Die.....2.6 x 0.10 x 3.0..6.3
 B. Ba. (S.S.)..3.4 x 1.6 x 0.8..3.4
 Weight complete 1675 lbs.

C.....	\$210.00
D.....	196.00
F.....	190.00
G.....	187.00
H.....	184.00
I.....	181.00
K.....	176.00
L.....	171.00

"M. M." finish

If Cross is omitted deduct \$12.00

No. 5308¹/₂

Die.....2.6 x 0.8 x 3.0..5.0
 B. Ba. (S.S.)..3.4 x 1.4 x 0.8..3.0
 Weight complete 1400 lbs.

C.....	\$189.00
D.....	178.00
F.....	173.00
G.....	170.00
H.....	167.00
I.....	164.00
K.....	160.00
L.....	156.00

"M. M." finish

If Cross is omitted deduct \$12.00

No. 5309

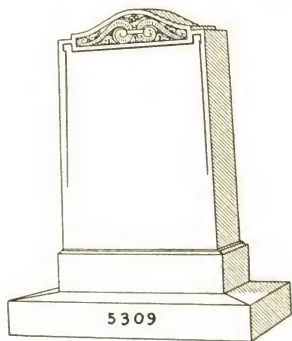

Die.....2.4 x 1.0 x 3.6..8.2
 Base.....2.6 x 1.2 x 0.8..1.11
 B.Ba. (S.S.) .3.6 x 1.10 x 0.6..3.3

Weight complete 2100 lbs.

C.....\$285.00
 D.....262.00
 F.....252.00
 G.....247.00
 H.....242.00
 I.....237.00
 K.....229.00
 L.....221.00

"M. M." finish

No. 5309¹/₄

Die.....2.4 x 0.10 x 3.6..6.10
 Base.....2.6 x 1.0 x 0.8..1.8
 B.Ba. (S.S.) .3.6 x 1.8 x 0.6..2.11

Weight complete 1980 lbs.

C.....\$252.00
 D.....233.00
 F.....224.00
 G.....220.00
 H.....216.00
 I.....212.00
 K.....206.00
 L.....200.00

"M. M." finish

No. 5309¹/₂

Die.....2.4 x 0.8 x 3.6..5.5
 Base.....2.6 x 0.10 x 0.8..1.5
 B.Ba. (S.S.) .3.6 x 1.6 x 0.6..2.8

Weight complete 1650 lbs.

C.....\$214.00
 D.....199.00
 F.....192.00
 G.....189.00
 H.....186.00
 I.....183.00
 K.....178.00
 L.....173.00

"M. M." finish

No. 5310

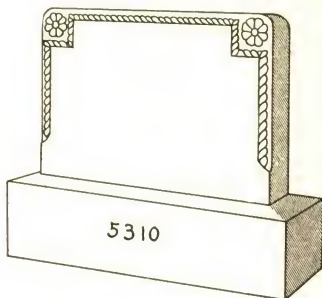

Die.....2.8 x 0.6 x 2.0..2.8
 B. Base.....3.2 x 1.0 x 0.10..2.8

Weight complete 925 lbs.; no B. B. 445 lbs.

C.....\$60.50
 D.....54.50
 F.....52.00
 G.....50.50
 H.....49.25
 I.....48.00
 K.....46.00
 L.....44.00

If B. B. is omitted deduct \$9.60

No. 5310¹/₄

Die.....2.8 x 0.4 x 2.0..1.9
 B. Base.....3.2 x 0.10 x 0.10..2.2

Weight complete 675 lbs.; no B. B. 285 lbs.

C.....\$47.00
 D.....43.00
 F.....41.25
 G.....40.25
 H.....39.25
 I.....38.25
 K.....37.00
 L.....35.75

If B. B. is omitted deduct \$7.80

No. 6502

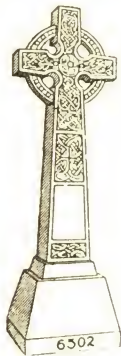

Cross..... 2.4 x 0.10 x 6.0.. 11.8
 Base..... 2.2 x 1.10 x 1.10.. 7.3

Weight complete 2900 lbs.

C.....	\$384.00
D.....	341.00
F.....	322.00
G.....	313.00
H.....	304.00
I.....	295.00
K.....	281.00
L.....	267.00

No. 6502¹/₄

Cross..... 2.2 x 0.8 x 5.6.. 7.11
 Base..... 2.0 x 1.8 x 1.8.. 5.7

Weight complete 2100 lbs.

C.....	\$289.00
D.....	259.00
F.....	245.00
G.....	239.00
H.....	233.00
I.....	226.00
K.....	216.00
L.....	206.00

No. 6502¹/₂

Cross..... 2.0 x 0.6 x 5.0.. 5.0
 Base..... 1.10 x 1.6 x 1.6.. 4.2

Weight complete 1400 lbs.

C.....	\$243.00
D.....	222.00
F.....	213.00
G.....	208.00
H.....	203.00
I.....	198.00
K.....	191.00
L.....	184.00

No. 6503

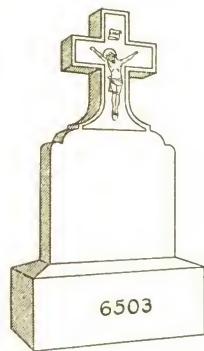

Cross..... 1.6 x 0.4 x 2.10.. 1.5
 B. Base..... 2.0 x 0.10 x 0.10.. 1.5

Weight complete 475 lbs.; no B. B. 220 lbs.

C.....	\$39.25
D.....	36.00
F.....	34.50
G.....	33.75
H.....	33.00
I.....	32.50
K.....	31.25
L.....	30.25

If B. B. is omitted deduct \$5.10
 Face only polished

No. 6503¹/₄

Cross..... 1.4 x 0.4 x 2.6.. 1.1
 B. Base..... 1.9 x 0.9 x 0.10.. 1.1

Weight complete 375 lbs.; no B. B. 180 lbs.

C.....	\$32.50
D.....	30.00
F.....	29.00
G.....	28.50
H.....	27.75
I.....	27.25
K.....	26.50
L.....	25.75

If B. B. is omitted deduct \$3.90
 Face only polished

No. 6503¹/₂

Cross..... 1.4 x 0.3 x 2.6.. 0.10
 B. Base..... 1.9 x 0.8 x 0.8.. 0.9

Weight complete 250 lbs.; no B. B. 115 lbs.

C.....	\$26.25
D.....	24.50
F.....	23.50
G.....	23.25
H.....	22.75
I.....	22.25
K.....	21.75
L.....	21.00

If B. B. is omitted deduct \$2.80
 Face only polished

No. 6504

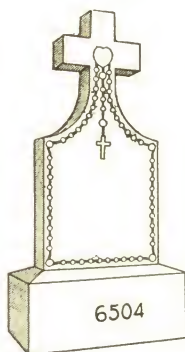

Cross.....1.6 x 0. 4 x 3. 0..1.6
 B. Base.....2.0 x 0.10 x 0.10..1.5
 Weight complete 490 lbs.; no B. B. 235 lbs.

- C.....\$42.00
- D.....38.50
- F.....37.00
- G.....36.25
- H.....35.50
- I.....34.75
- K.....33.50
- L.....32.50

If B. B. is omitted deduct \$5.10
 Face only polished

No. 6504¹/₄

Cross.....1.4 x 0.4 x 2.10..1.3
 B. Base.....1.9 x 0.9 x 0.10..1.1
 Weight complete 400 lbs.; no B. B. 205 lbs.

- C.....\$35.25
- D.....32.50
- F.....31.00
- G.....30.50
- H.....29.75
- I.....29.25
- K.....28.25
- L.....27.25

If B. B. is omitted deduct \$3.90
 Face only polished

No. 6504¹/₂

Cross.....1.4 x 0.3 x 2.10..0.11
 B. Base.....1.9 x 0.8 x 0. 8..0. 9
 Weight complete 275 lbs.; no B. B. 140 lbs.

- C.....\$27.75
- D.....25.75
- F.....24.75
- G.....24.25
- H.....23.75
- I.....23.50
- K.....22.75
- L.....22.00

If B. B. is omitted deduct \$2.80
 Face only polished

No. 6505

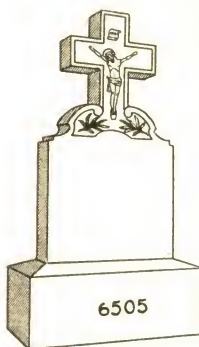

Cross.....1.6 x 0. 4 x 2.10..1.5
 B. Base.....2.0 x 0.10 x 0.10..1.5
 Weight complete 475 lbs.; no B. B. 220 lbs.

- C.....\$42.75
- D.....39.50
- F.....38.00
- G.....37.25
- H.....36.50
- I.....36.00
- K.....34.75
- L.....33.75

If B. B. is omitted deduct \$5.10
 Face only polished

No. 6505¹/₄

Cross.....1.4 x 0.4 x 2. 6..1.1
 B. Base.....1.9 x 0.9 x 0.10..1.1
 Weight complete 375 lbs.; no B. B. 180 lbs.

- C.....\$33.75
- D.....31.25
- F.....30.25
- G.....29.75
- H.....29.00
- I.....28.50
- K.....27.75
- L.....27.00

If B. B. is omitted deduct \$3.90
 Face only polished

No. 6505¹/₂

Cross.....1.4 x 0.3 x 2.6..0.10
 B. Base.....1.9 x 0.8 x 0.8..0. 9
 Weight complete 225 lbs.; no B. B. 90 lbs.

- C.....\$28.50
- D.....26.75
- F.....25.75
- G.....25.50
- H.....25.00
- I.....24.50
- K.....24.00
- L.....23.25

If B. B. is omitted deduct \$2.80
 Face only polished

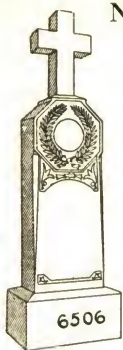

No. 6506

Cross.....	1. 2 x 0. 4 x 1.6..	0.7
Die.....	1. 4 x 0.10 x 3.0..	3.4
B. Base.....	1.10 x 1. 4 x 1.0..	2.5
Weight complete 1140 lbs.; no B. B. 705 lbs.		
D.....		\$67.00
G.....		61.00
H.....		59.00
I.....		57.00
K.....		54.00
L.....		51.50
If B. B. is omitted deduct \$8.70		

No. 6506¹/₄

Cross.....	1. 0 x 0.4 x 1. 4..	0.5
Die.....	1. 4 x 0.8 x 2.10..	2.6
B. Base.....	1.10 x 1.2 x 1. 0..	2.2
Weight complete 915 lbs.; no B. B. 525 lbs.		
D.....		\$55.00
G.....		50.50
H.....		49.00
I.....		47.75
K.....		45.50
L.....		43.25
If B. B. is omitted deduct \$7.80		

No. 6506¹/₂

Cross.....	1.0 x 0.4 x 1. 4..	0. 5
Die.....	1.2 x 0.8 x 2.10..	2. 2
B. Base.....	1.8 x 1.2 x 1. 0..	1.11
Weight complete 810 lbs.; no B. B. 465 lbs.		
D.....		\$51.00
G.....		47.50
H.....		46.00
I.....		44.75
K.....		43.00
L.....		41.00
If B. B. is omitted deduct \$6.90		

No. 6506³/₄

Cross.....	0.10 x 0. 3 x 1. 2..	0. 3
Die.....	1. 0 x 0. 6 x 2. 8..	1. 4
B. Base.....	1. 4 x 0.10 x 0.10..	0.11
Weight complete 450 lbs.; no B. B. 285 lbs.		
D.....		\$32.00
G.....		29.75
H.....		28.75
I.....		28.00
K.....		27.00
L.....		25.75
If B. B. is omitted deduct \$3.45		

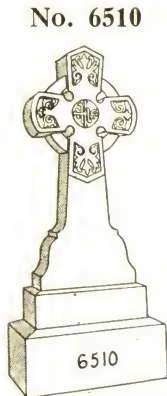

No. 6510

Cross.....	2.4 x 0.10 x 4.10..	9. 5
Base.....	2.6 x 1. 2 x 0. 8..	1.11
B. Base.....	3.0 x 1. 8 x 1. 2..	5.10
Weight complete 2800 lbs.; no B. B. 1750 lbs.		

C.....		\$242.00
D.....		217.00
F.....		205.00
G.....		200.00
H.....		194.00
I.....		188.00
K.....		180.00
L.....		171.00

If B. B. is omitted deduct \$20.40

No. 6510¹/₄

Cross.....	2.0 x 0.8 x 4.2..	5.7
Base.....	2.2 x 1.0 x 0.8..	1.5
B. Base.....	2.8 x 1.6 x 1.0..	4.0
Weight complete 1800 lbs.; no B. B. 1080 lbs.		

C.....		\$172.00
D.....		157.00
F.....		150.00
G.....		146.00
H.....		143.00
I.....		139.00
K.....		134.00
L.....		129.00

If B. B. is omitted deduct \$14.00

No. 6510¹/₂

Cross.....	1. 8 x 0. 6 x 3.6..	2.11
Base.....	1.10 x 0.10 x 0.6..	0. 9
B. Base.....	2. 4 x 1. 4 x 1.0..	3. 1
Weight complete 1100 lbs.; no B. B. 545 lbs.		

C.....		\$114.00
D.....		106.00
F.....		102.00
G.....		100.00
H.....		98.50
I.....		96.50
K.....		94.00
L.....		91.00

If B. B. is omitted deduct \$10.80

No. 6518

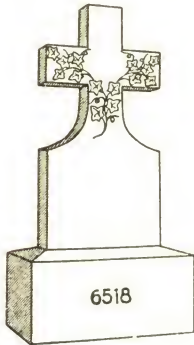

Cross.....1.4 x 0.4 x 2.4 .1.0
 B. Base.....1.9 x 0.9 x 0.10 .1.1
 Weight complete 325 lbs.; no B. B. 130 lbs.

- C.....\$28.00
- D.....25.75
- F.....24.75
- G.....24.25
- H.....23.75
- I.....23.25
- K.....22.50
- L.....21.75

If B. B. is omitted deduct \$3.90
 Face only polished; back and edges sand finished.

No. 6518¹/₄

Cross.....1.0 x 0.4 x 2.0 .0.8
 B. Base.....1.4 x 0.8 x 0.8 .0.7
 Weight complete 200 lbs.; no B. B. 95 lbs.

- C.....\$20.25
- D.....18.75
- F.....18.25
- G.....17.75
- H.....17.50
- I.....17.25
- K.....16.75
- L.....16.25

If B. B. is omitted deduct \$2.20
 Face only polished; back and edges sand finished.

No. 6518¹/₂

Cross.....1.0 x 0.3 x 1.8 .0.5
 B. Base.....1.4 x 0.7 x 0.6 .0.5
 Weight complete 125 lbs.; no B. B. 50 lbs.

- C.....\$15.00
- D.....14.00
- F.....13.75
- G.....13.50
- H.....13.25
- I.....13.00
- K.....12.50
- L.....12.25

If B. B. is omitted deduct \$1.55
 Face only polished; back and edges sand finished.

No. 6519

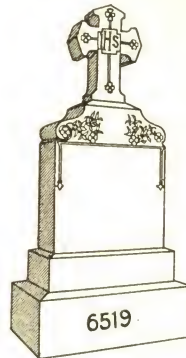

Cross.....1.6 x 0.6 x 2.0 .1.6
 Die.....2.6 x 1.0 x 3.0 .7.6
 Base.....2.10 x 1.4 x 0.8 .2.6
 B. Base.....3.4 x 1.10 x 1.2 .7.2
 Weight complete 3000 lbs.; no B. B. 1710 lbs.

- D.....\$195.00
- G.....178.00
- H.....172.00
- I.....166.00
- K.....157.00
- L.....149.00

If B. B. is omitted deduct \$25.10
 Edges of cross and cut parts of die sand finished.

No. 6519¹/₄

Cross.....1.4 x 0.5 x 1.10 .1.0
 Die.....2.4 x 0.10 x 2.10 .5.6
 Base.....2.8 x 1.2 x 0.8 .2.1
 B. Base.....3.2 x 1.8 x 1.0 .5.3
 Weight complete 2300 lbs.; no B. B. 1355 lbs.

- D.....\$152.00
- G.....139.00
- H.....135.00
- I.....131.00
- K.....124.00
- L.....118.00

If B. B. is omitted deduct \$18.40
 Edges of cross and cut parts of die sand finished.

No. 6519¹/₂

Cross.....1.2 x 0.4 x 1.8 .0.8
 Die.....2.2 x 0.8 x 2.8 .3.10
 Base.....2.6 x 1.0 x 0.8 .1.8
 B. Base.....3.0 x 1.6 x 1.0 .4.6
 Weight complete 1850 lbs.; no B. B. 1040 lbs.

- D.....\$118.00
- G.....109.00
- H.....106.00
- I.....103.00
- K.....98.00
- L.....93.50

If B. B. is omitted deduct \$15.75
 Edges of cross and cut parts of die sand finished.

No. 6520

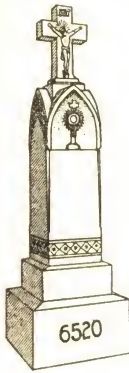

Cross.....1.0 x 0.6 x 1.7 .0.10
 Die.....1.2 x 1.2 x 3.8 .5. 0
 Base.....1.6 x 1.6 x 0.8 .1. 6
 B. Base.....2.0 x 2.0 x 1.2 .4. 8
 Weight complete 2000 lbs.; no B. B. 1160 lbs.

C.....\$175.00
 D.....159.00
 F.....151.00
 G.....148.00
 H.....144.00
 I.....140.00
 K.....135.00
 L.....129.00

If B. B. is omitted deduct \$16.35

If emblem on face of die is omitted and face traced same as other three sides deduct \$13.00.

No. 6520¹/₄

Cross.....1. 0 x 0. 5 x 1.6 .0.8
 Die.....1. 0 x 1. 0 x 3.4 .3.4
 Base.....1. 4 x 1. 4 x 0.8 .1.2
 B. Base.....1.10 x 1.10 x 1.0 .3.4
 Weight complete 1450 lbs.; no B. B. 850 lbs.

C. \$134.00 H. \$112.00
 D. 123.00 I. 110.00
 F. 117.00 K. 106.00
 G. 115.00 L. 102.00

If B. B. is omitted deduct \$11.65

If emblem on face of die is omitted and face traced same as other three sides deduct \$12.00.

No. 6520¹/₂

Cross.....0.10 x 0. 4 x 1.4 .0. 4
 Die.....0.10 x 0.10 x 3.0 .2. 1
 Base.....1. 2 x 1. 2 x 0.8 .0.11
 B. Base.....1. 6 x 1. 6 x 1.0 .2. 3
 Weight complete 950 lbs.; no B. B. 545 lbs.

C. \$103.00 H. \$88.50
 D. 95.00 I. 87.00
 F. 92.00 K. 84.50
 G. 90.00 L. 82.00

If B. B. is omitted deduct \$8.10

If emblem on face of die is omitted and face traced same as other three sides deduct \$11.50.

No. 6522



Cross.....1.0 x 0.6 x 1.7 .0.10
 Die.....1.2 x 1.2 x 3.8 .5. 0
 Base.....1.6 x 1.6 x 0.8 .1. 6
 B. Base.....2.0 x 2.0 x 1.2 .4. 8
 Weight complete 2000 lbs.; no B. B. 1160 lbs.

C.....\$146.00
 D.....130.00
 F.....122.00
 G.....119.00
 H.....115.00
 I.....111.00
 K.....106.00
 L.....100.00

If B. B. is omitted deduct \$16.35

No. 6522¹/₄

Cross.....1. 0 x 0. 5 x 1.6 .0.8
 Die.....1. 0 x 1. 0 x 3.4 .3.4
 Base.....1. 4 x 1. 4 x 0.8 .1.2
 B. Base.....1.10 x 1.10 x 1.0 .3.4
 Weight complete 1450 lbs.; no B. B. 850 lbs.

C.....\$105.00
 D.....93.50
 F.....88.50
 G.....86.00
 H.....83.50
 I.....80.50
 K.....77.00
 L.....73.00

If B. B. is omitted deduct \$11.65

No. 6522¹/₂

Cross.....0.10 x 0. 4 x 1.4 .0. 4
 Die.....0.10 x 0.10 x 3.0 .2. 1
 Base.....1. 2 x 1. 2 x 0.8 .0.11
 B. Base.....1. 6 x 1. 6 x 1.0 .2. 3
 Weight complete 950 lbs.; no B. B. 545 lbs.

C.....\$75.50
 D.....68.00
 F.....65.00
 G.....63.00
 H.....61.50
 I.....60.00
 K.....57.50
 L.....55.00

If B. B. is omitted deduct \$8.10

No. 6524

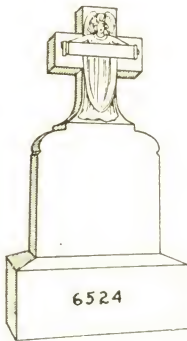

Cross.....1.8 x 0.8 x 3.6 .3.11
 B. Base.....2.2 x 1.2 x 1.0 .2. 6
 Weight complete 1000 lbs.; no B. B. 550 lbs.

- C.....\$97.50
- D.....88.50
- F.....84.50
- G.....82.50
- H.....80.50
- I.....78.50
- K.....75.50
- L.....73.00

If B. B. is omitted deduct \$9.00
 All polished
 If face only polished deduct \$4.50

No. 6525

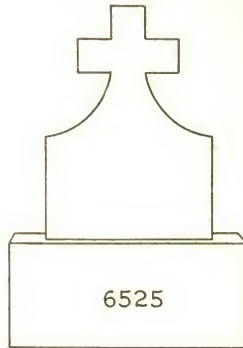

Cross.....1.2 x 0.4 x 1.6 .0.7
 B. Base.....1.7 x 0.9 x 0.6 .0.7
 Weight complete 175 lbs.; no B. B. 70 lbs.

- C.....\$18.25
- D.....17.00
- F.....16.50
- G.....16.25
- H.....15.75
- I.....15.50
- K.....15.25
- L.....14.75

If B. B. is omitted deduct \$2.20
 Face only polished

No. 6525¹/₄

Cross.....1.0 x 0.4 x 1.6 .0.6
 B. Base.....1.5 x 0.9 x 0.6 .0.6
 Weight complete 150 lbs.; no B. B. 60 lbs.

- C.....\$15.75
- D.....14.50
- F.....14.00
- G.....13.75
- H.....13.50
- I.....13.25
- K.....12.75
- L.....12.50

If B. B. is omitted deduct \$1.90
 Face only polished

No. 6524¹/₄

Cross.....1.6 x 0.6 x 3. 0. .2.3
 B. Base.....2.0 x 1.0 x 0.10 .1.8
 Weight complete 600 lbs.; no B. B. 300 lbs.

- C.....\$64.00
- D.....59.00
- F.....57.00
- G.....55.50
- H.....54.50
- I.....53.50
- K.....52.00
- L.....50.00

If B. B. is omitted deduct \$6.00
 All polished
 If face only polished deduct \$3.50

No. 6525¹/₂

Cross.....0.10 x 0.3 x 1.2 .0.3
 B. Base.....1. 2 x 0.7 x 0.4 .0.3
 Weight complete 75 lbs.; no B. B. 30 lbs.

- C.....\$9.50
- D.....9.00
- F.....8.75
- G.....8.50
- H.....8.50
- I.....8.25
- K.....8.00
- L.....7.75

If B. B. is omitted deduct \$.95
 Face only polished

No. 6526



Cross.....1.2 x 0.4 x 1.6 . . 0.7
 B. Base.....1.7 x 0.9 x 0.6 . . 0.7

Weight complete 175 lbs.; no B. B. 70 lbs.

- C.....\$18.25
- D.....17.00
- F.....16.50
- G.....16.25
- H.....15.75
- I.....15.50
- K.....15.25
- L.....14.75

If B. B. is omitted deduct \$2.20
 Face only polished

No. 6526¹/₄

Cross.....1.0 x 0.4 x 1.6 . . 0.6
 B. Base.....1.5 x 0.9 x 0.6 . . 0.6

Weight complete 150 lbs.; no B. B. 60 lbs.

- C.....\$15.75
- D.....14.50
- F.....14.00
- G.....13.75
- H.....13.50
- I.....13.25
- K.....12.75
- L.....12.50

If B. B. is omitted deduct \$1.90
 Face only polished

No. 6526¹/₂

Cross.....0.10 x 0.3 x 1.2 . . 0.3
 B. Base.....1.2 x 0.7 x 0.4 . . 0.3

Weight complete 75 lbs.; no B. B. 30 lbs.

- C.....\$9.50
- D.....9.00
- F.....8.75
- G.....8.50
- H.....8.50
- I.....8.25
- K.....8.00
- L.....7.75

If B. B. is omitted deduct \$.95
 Face only polished

No. 6527

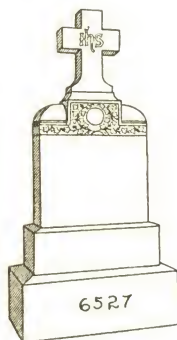

Cross.....1.6 x 0.6 x 2.0 . . 1.6
 Die.....2.6 x 1.0 x 3.0 . . 7.6

Base.....2.10 x 1.4 x 0.10 . . 3.2

B. Base...3.4 x 1.10 x 1.2 . . 7.2

Weight complete 3100 lbs.; no B. B. 2200 lbs.

- D.....\$196.00
- G.....178.00
- H.....172.00
- I.....166.00
- K.....157.00
- L.....147.00

If B. B. is omitted deduct \$25.10
 Edges of cross and cut parts of die sand finished.

No. 6527¹/₄

Cross.....1.4 x 0.5 x 1.10 . . 1.0
 Die.....2.4 x 0.10 x 2.10 . . 5.6

Base.....2.8 x 1.2 x 0.8 . . 2.1

B. Base...3.2 x 1.8 x 1.0 . . 5.3

Weight complete 2550 lbs.; no B. B. 1635 lbs.

- D.....\$142.00
- G.....131.00
- H.....126.00
- I.....122.00
- K.....115.00
- L.....108.00

If B. B. is omitted deduct \$18.40
 Edges of cross and cut parts of die sand finished.

No. 6527¹/₂

Cross.....1.2 x 0.5 x 1.8 . . 0.10
 Die.....2.2 x 0.8 x 2.8 . . 3.10

Base.....2.6 x 1.0 x 0.8 . . 1.8

B. Base...3.0 x 1.6 x 1.0 . . 4.6

Weight complete 2000 lbs.; no B. B. 1140 lbs.

- D.....\$113.00
- G.....104.00
- H.....101.00
- I.....97.00
- K.....92.50
- L.....88.00

If B. B. is omitted deduct \$15.75
 Edges of cross and cut parts of die sand finished.

No. 6528

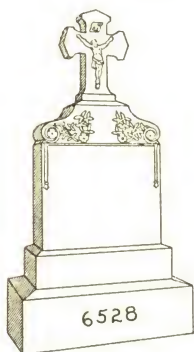

Cross.....1. 6 x 0. 6 x 2. 0. .1. 6
 Die.....2. 6 x 1. 0 x 3. 0. .7. 6
 Base.....2. 10 x 1. 4 x 0. 8. .2. 6
 B. Base....3. 4 x 1. 10 x 1. 2. .7. 2
 Weight complete 3000 lbs.; no B. B. 1710 lbs.

C.....\$250.00
 D.....224.00
 F.....212.00
 G.....207.00
 H.....201.00
 I.....195.00
 K.....186.00
 L.....178.00

If B. B. is omitted deduct \$25.10
 Edges of cross and cut parts of die sand finished.

No. 6528¹/₄

Cross.....1. 4 x 0. 5 x 1. 10. .1. 0
 Die.....2. 4 x 0. 10 x 2. 10. .5. 6
 Base.....2. 8 x 1. 2 x 0. 8. .2. 1
 B. Base....3. 2 x 1. 8 x 1. 0. .5. 3
 Weight complete 2300 lbs.; no B. B. 1355 lbs.

C.....\$195.00
 D.....175.00
 F.....167.00
 G.....162.00
 H.....158.00
 I.....154.00
 K.....147.00
 L.....141.00

If B. B. is omitted deduct \$18.40
 Edges of cross and cut parts of die sand finished.

No. 6528¹/₂

Cross.....1. 2 x 0. 4 x 1. 8. .0. 8
 Die.....2. 2 x 0. 8 x 2. 8. .3. 10
 Base.....2. 6 x 1. 0 x 0. 8. .1. 8
 B. Base....3. 0 x 1. 6 x 1. 0. .4. 6
 Weight complete 1850 lbs.; no B. B. 1040 lbs.

C.....\$152.00 I.....\$126.00
 D.....138.00 L.....123.00
 F.....132.00 K.....118.00
 G.....129.00 L.....113.00

If B. B. is omitted deduct \$15.75
 Edges of cross and cut parts of die sand finished

No. 6529

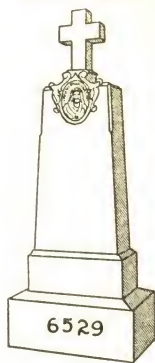

Cross.....0. 11 x 0. 4 x 1. 3. .0. 5
 Die.....1. 10 x 0. 10 x 3. 4. .5. 1
 Base.....2. 0 x 1. 0 x 0. 8. .1. 4
 B. Base....2. 6 x 1. 6 x 1. 0. .3. 9
 Weight complete 1750 lbs.; no B. B. 1075 lbs.

C.....\$185.00
 D.....169.00
 F.....163.00
 G.....159.00
 H.....156.00
 I.....152.00
 K.....147.00
 L.....142.00

If B. B. is omitted deduct \$13.15

No. 6529¹/₄

Cross.....0. 9 x 0. 3 x 1. 0. .0. 2
 Die.....1. 6 x 0. 8 x 3. 0. .3. 0
 Base.....1. 8 x 0. 10 x 0. 8. .0. 11
 B. Base....2. 2 x 1. 4 x 0. 10. .2. 5
 Weight complete 1000 lbs.; no B. B. 565 lbs.

C.....\$136.00
 D.....127.00
 F.....123.00
 G.....121.00
 H.....119.00
 I.....117.00
 K.....114.00
 L.....111.00

If B. B. is omitted deduct \$8.70

No. 6529¹/₂

Cross.....0. 9 x 0. 3 x 1. 0. .0. 2
 Die.....1. 6 x 0. 6 x 3. 0. .2. 3
 Base.....1. 8 x 0. 8 x 0. 6. .0. 7
 B. Base....2. 2 x 1. 2 x 0. 10. .2. 1
 Weight complete 800 lbs.; no B. B. 425 lbs.

C.....\$119.00
 D.....113.00
 F.....110.00
 G.....108.00
 H.....107.00
 I.....105.00
 K.....103.00
 L.....101.00

If B. B. is omitted deduct \$7.50

No. 6530

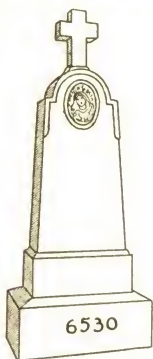

Cross.....	0.11 x 0.4 x 1.3..	0.5
Die.....	1.10 x 0.10 x 3.4..	5.1
Base.....	2.0 x 1.0 x 0.8..	1.4
B. Base....	2.6 x 1.6 x 1.0..	3.9
Weight complete 1750 lbs.; no B. B. 1075 lbs.		
C.....		\$179.00
D.....		163.00
F.....		157.00
G.....		153.00
H.....		150.00
I.....		146.00
K.....		141.00
L.....		136.00
If B. B. is omitted deduct \$13.15		

No. 6530¹/₄

Cross.....	0.8 x 0.3 x 0.11..	0.2
Die.....	1.6 x 0.8 x 3.0..	3.0
Base.....	1.8 x 0.10 x 0.8..	0.11
B. Base....	2.2 x 1.4 x 0.10..	2.5
Weight complete 1000 lbs.; no B. B. 565 lbs.		
C.....		\$128.00
D.....		119.00
F.....		115.00
G.....		113.00
H.....		111.00
I.....		109.00
K.....		106.00
L.....		103.00
If B. B. is omitted deduct \$3.70		

No. 6530¹/₂

Cross.....	0.8 x 0.3 x 0.11..	0.2
Die.....	1.6 x 0.6 x 3.0..	2.3
Base.....	1.8 x 0.8 x 0.6..	0.7
B. Base....	2.2 x 1.2 x 0.10..	2.1
Weight complete 800 lbs.; no B. B. 425 lbs.		
C.....		\$113.00
D.....		106.00
F.....		104.00
G.....		102.00
H.....		101.00
I.....		99.00
K.....		97.00
L.....		94.50
If B. B. is omitted deduct \$7.50		

No. 6532

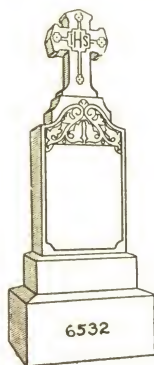

Cross.....	1.2 x 0.5 x 1.8..	0.10
Die.....	1.8 x 0.10 x 3.0..	4.2
Base.....	2.0 x 1.2 x 0.8..	1.7
B. Base....	2.6 x 1.8 x 1.2..	4.10
Weight complete 2000 lbs.; no B. B. 1130 lbs.		
C.....		\$143.00
D.....		128.00
F.....		122.00
G.....		118.00
H.....		115.00
I.....		112.00
K.....		107.00
L.....		102.00
If B. B. is omitted deduct \$16.90		

No. 6532¹/₄

Cross.....	1.2 x 0.5 x 1.8..	0.10
Die.....	1.6 x 0.10 x 3.0..	3.9
Base.....	1.10 x 1.2 x 0.8..	1.5
B. Base....	2.4 x 1.8 x 1.2..	4.6
Weight complete 1825 lbs.; no B. B. 1015 lbs.		
C.....		\$131.00
D.....		117.00
F.....		111.00
G.....		108.00
H.....		105.00
I.....		102.00
K.....		97.50
L.....		93.00
If B. B. is omitted deduct \$15.75		

No. 6532¹/₂

Cross.....	1.1 x 0.4 x 1.6..	0.7
Die.....	1.4 x 0.8 x 2.10..	2.6
Base.....	1.8 x 1.0 x 0.8..	1.1
B. Base....	2.0 x 1.4 x 0.10..	2.3
Weight complete 1100 lbs.; no B. B. 695 lbs.		
C.....		\$94.00
D.....		84.50
F.....		80.50
G.....		78.50
H.....		76.50
I.....		74.00
K.....		71.00
L.....		68.00
If B. B. is omitted deduct \$8.10		

No. 6533

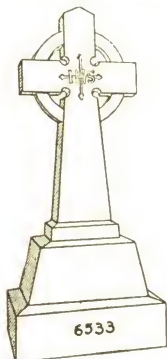

Cross.....2.9 x 0.10 x 5.0.. 11.6
 Die.....2.9 x 1.8 x 1.8.. 7.8
 B. Base....3.5 x 2.4 x 1.0.. 8.0
 Weight complete 4400 lbs.; no B.B.2960 lbs.

- C.....\$343.00
- D.....300.00
- F.....281.00
- G.....271.00
- H.....261.00
- I.....251.00
- K.....237.00
- L.....223.00

If B. B. is omitted deduct \$28.00
 Sand finished

No. 6533¹/₄

Cross.....2.6 x 0.8 x 4.8.. 7.9
 Die.....2.6 x 1.6 x 1.6.. 5.8
 B. Base....3.0 x 2.0 x 1.0.. 6.0
 Weight complete 3100 lbs.; no B.B.2020 lbs.

- C.....\$246.00
- D.....216.00
- F.....203.00
- G.....196.00
- H.....189.00
- I.....182.00
- K.....172.00
- L.....162.00

If B. B. is omitted deduct \$21.00
 Sand finished

No. 6533¹/₂

Cross.....2.0 x 0.6 x 4.0.. 4.0
 Die.....2.0 x 1.4 x 1.4.. 3.7
 B. Base....2.6 x 1.10 x 0.10.. 3.10
 Weight complete 1800 lbs.; no B.B.1110 lbs.

- C.....\$164.00
- D.....147.00
- F.....139.00
- G.....135.00
- H.....131.00
- I.....127.00
- K.....121.00
- L.....115.00

If B. B. is omitted deduct \$13.40
 Sand finished

No. 6535

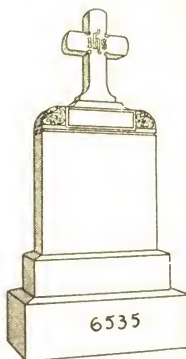

Cross.....1.6 x 0.6 x 2.0.. 1.6
 Die.....2.6 x 1.0 x 3.0.. 7.6
 Base.....2.10 x 1.4 x 0.8.. 2.6
 B. Base....3.4 x 1.10 x 1.2.. 7.2
 Weight complete 3000 lbs.; no B.B.1710 lbs.

- C.....\$225.00
- D.....199.00
- F.....187.00
- G.....182.00
- H.....176.00
- I.....170.00
- K.....161.00
- L.....153.00

If B. B. is omitted deduct \$25.10

No. 6535¹/₄

Cross.....1.4 x 0.5 x 1.10.. 1.0
 Die.....2.4 x 0.10 x 2.10.. 5.6
 Base.....2.8 x 1.2 x 0.8.. 2.1
 B. Base....3.2 x 1.8 x 1.0.. 5.3
 Weight complete 2200 lbs.; no B.B.1255 lbs.

- C.....\$174.00
- D.....154.00
- F.....146.00
- G.....141.00
- H.....137.00
- I.....133.00
- K.....126.00
- L.....120.00

If B. B. is omitted deduct \$18.40

No. 6535¹/₂

Cross.....1.2 x 0.4 x 1.8.. 0.8
 Die.....2.2 x 0.8 x 2.8.. 3.10
 Base.....2.6 x 1.0 x 0.8.. 1.8
 B. Base....3.0 x 1.6 x 1.0.. 4.6
 Weight complete 1800 lbs.; no B. B. 990 lbs.

- C.....\$136.00
- D.....122.00
- F.....116.00
- G.....113.00
- H.....110.00
- I.....107.00
- K.....102.00
- L.....97.50

If B. B. is omitted deduct \$15.75

No. 6536

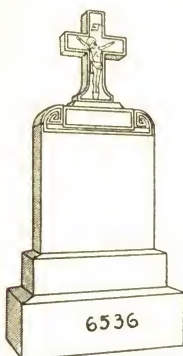

Cross.....1. 6 x 0. 6 x 2.0..1.6
 Die.....2. 6 x 1. 0 x 3.0..7.6
 Base.....2.10 x 1. 4 x 0.8..2.6
 B. Base....3. 4 x 1.10 x 1.2..7.2
 Weight complete 3000 lbs.; no B.B.1710 lbs.

C.....\$215.00
 D.....189.00
 F.....177.00
 G.....172.00
 H.....166.00
 I.....160.00
 K.....151.00
 L.....143.00
 If B. B. is omitted deduct \$25.10

No. 6536¹/₄

Cross.....1.4 x 0. 5 x 1.10..1.0
 Die.....2.4 x 0.10 x 2.10..5.6
 Base.....2.8 x 1. 2 x 0. 8..2.1
 B. Base....3.2 x 1. 8 x 1. 0..5.3
 Weight complete 2200 lbs.; no B.B.1255 lbs.

C.....\$166.00
 D.....146.00
 F.....138.00
 G.....133.00
 H.....129.00
 I.....125.00
 K.....118.00
 L.....112.00
 If B. B. is omitted deduct \$18.40

No. 6536¹/₂

Cross.....1.2 x 0.4 x 1.8..0.8
 Die.....2.2 x 0.8 x 2.8..3.10
 Base.....2.6 x 1.0 x 0.8..1.8
 B. Base....3.0 x 1.6 x 1.0..4.6
 Weight complete 1800 lbs.; no B. B. 990 lbs.

C.....\$128.00
 D.....114.00
 F.....108.00
 G.....105.00
 H.....102.00
 I.....98.50
 K.....94.00
 L.....89.50
 If B. B. is omitted deduct \$15.75

No. 6537

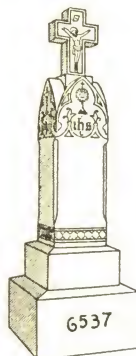

Cross.....1.0 x 0.4 x 1. 4..0.5
 Die.....1.2 x 1.2 x 3. 4..4.6
 Base.....1.6 x 1.6 x 0.10..1.11
 B. Base....2.0 x 2.0 x 1. 0..4.0
 Weight complete 1850 lbs.; no B.B.1130 lbs.

H.....\$110.00
 I.....106.00
 K.....101.00
 L.....96.00
 If B. B. is omitted deduct \$14.03

No. 6537¹/₄

Cross.....0.10 x 0. 4 x 1.2..0.4
 Die.....1. 0 x 1. 0 x 3.0..3.0
 Base.....1. 4 x 1. 4 x 0.8..1.2
 B. Base....1.10 x 1.10 x 1.0..3.4
 Weight complete 1300 lbs.; no B.B.700 lbs.

H.....\$80.00
 I.....77.50
 K.....74.00
 L.....71.00
 If B. B. is omitted deduct \$11.65

No. 6537¹/₂

Cross.....0.10 x 0. 3 x 1. 2..0.3
 Die.....0.10 x 0.10 x 2.10..2.0
 Base.....1. 2 x 1. 2 x 0. 8..0.11
 B. Base....1. 6 x 1. 6 x 0.10..1.11
 Weight complete 850 lbs.; no B. B. 505 lbs.

H.....\$61.00
 I.....59.00
 K.....57.00
 L.....54.50
 If B. B. is omitted deduct \$6.90

No. 6537³/₄

Cross.....0.8 x 0.2 x 1. 0..0.1
 Die.....0.8 x 0.8 x 2. 6..1.1
 Base.....1.0 x 1.0 x 0. 6..0.6
 B. Base....1.4 x 1.4 x 0.10..1.6
 Weight complete 500 lbs.; no B. B. 230 lbs.

H.....\$43.75
 I.....43.00
 K.....41.75
 L.....40.50
 If B. B. is omitted deduct \$5.40

No. 6538



Cross.....2.0 x 0.10 x 5.6 . .9.2
 B. Base.....2.0 x 1.8 x 0.8 . .2.3
 Weight complete 1900 lbs.; no E. B. 1495 lbs.

C.....	\$237.00
D.....	217.00
F.....	207.00
G.....	203.00
H.....	198.00
I.....	194.00
K.....	187.00
L.....	180.00

If B. B. is omitted deduct \$8.10
 Pumice finished

No. 6538¹/₄

Cross.....1.10 x 0.8 x 5.0 . .6.1
 B. Base.....1.10 x 1.6 x 0.6 . .1.5
 Weight complete 1200 lbs.; no B. B. 975 lbs.

C.....	\$182.00
D.....	168.00
F.....	162.00
G.....	159.00
H.....	156.00
I.....	153.00
K.....	148.00
L.....	144.00

If B. B. is omitted deduct \$5.10
 Pumice finished

No. 6538¹/₂

Cross.....1.8 x 0.6 x 4.6 . .3.9
 B. Base.....1.8 x 1.4 x 0.6 . .1.1
 Weight complete 725 lbs.; no B. B. 530 lbs.

C.....	\$135.00
D.....	127.00
F.....	123.00
G.....	121.00
H.....	119.00
I.....	118.00
K.....	115.00
L.....	112.00

If B. B. is omitted deduct \$3.90
 Pumice finished

No. 6539

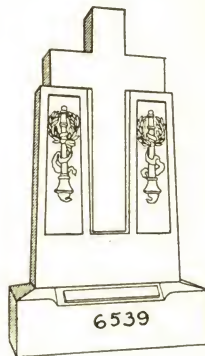

Die.....2.6 x 0.10 x 4.6 . .9.5
 B. Base.....3.2 x 1.6 x 1.2 . .5.7
 Weight complete 2350 lbs.

C.....	\$224.00
D.....	203.00
F.....	193.00
G.....	189.00
H.....	184.00
I.....	179.00
K.....	172.00
L.....	165.00

If B. B. is omitted deduct \$19.55

No. 6539¹/₄

Die.....2.6 x 0.8 x 4.6 . .7.6
 B. Base.....3.2 x 1.4 x 1.0 . .4.3
 Weight complete 1900 lbs.

C.....	\$190.00
D.....	173.00
F.....	165.00
G.....	162.00
H.....	158.00
I.....	154.00
K.....	148.00
L.....	143.00

If B. B. is omitted deduct \$14.90

No. 6540

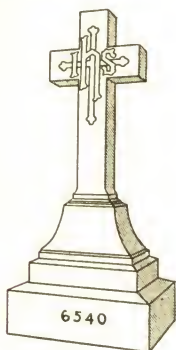

Cross.....	2.4 x 0.10 x 4.4..	8. 5
Die.....	2.4 x 1. 8 x 1.6..	5. 10
Base.....	2.8 x 2. 0 x 0.6..	2. 8
B. Base....	3.4 x 2. 8 x 1.2..	10. 4
Weight complete 4905 lbs.; no B. B. 3045 lbs.		
C.....		\$327.00
D.....		288.00
F.....		272.00
G.....		263.00
H.....		255.00
I.....		246.00
K.....		233.00
L.....		221.00
If B. B. is omitted deduct \$36.15		
All sand finished		

No. 6540¹/₄

Cross.....	2.2 x 0. 8 x 4.2..	6. 0
Die.....	2.2 x 1. 6 x 1.4..	4. 4
Base.....	2.6 x 1.10 x 0.6..	2. 4
B. Base....	3.2 x 2. 6 x 1.0..	7. 11
Weight complete 3705 lbs.; no B. B. 2280 lbs.		
C.....		\$253.00
D.....		224.00
F.....		212.00
G.....		205.00
H.....		199.00
I.....		193.00
K.....		183.00
L.....		174.00
If B. B. is omitted deduct \$27.70		
All sand finished		

No. 6540¹/₂

Cross.....	2.0 x 0.6 x 4.0..	4. 0
Die.....	2.0 x 1.4 x 1.2..	3. 1
Base.....	2.4 x 1.8 x 0.6..	1. 11
B. Base....	3.0 x 2.4 x 1.0..	7. 0
Weight complete 2880 lbs.; no B. B. 1620 lbs.		
C.....		\$207.00
D.....		187.00
F.....		178.00
G.....		173.00
H.....		\$169.00
I.....		164.00
K.....		157.00
L.....		151.00
If B. B. is omitted deduct \$24.50		
All sand finished		

No. 6541

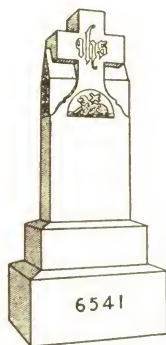

Die.....	1.4 x 0.10 x 3.0..	3.4
Base.....	1.8 x 1. 2 x 0.8..	1.4
B. Base....	2.2 x 1. 8 x 1.0..	3.7
Weight complete 1495 lbs.; no B. B. 840 lbs.		
C.....		\$100.00
D.....		89.50
F.....		84.50
G.....		82.50
H.....		80.00
I.....		77.50
K.....		74.00
L.....		70.50
If B. B. is omitted deduct \$12.55		

No. 6541¹/₄

Die.....	1.2 x 0.8 x 2.8..	2. 1
Base.....	1.6 x 1.0 x 0.8..	1. 0
B. Base....	2.0 x 1.6 x 1.0..	3. 0
Weight complete 1095 lbs.; no B. B. 555 lbs.		
C.....		\$74.50
D.....		67.50
F.....		64.50
G.....		63.00
H.....		61.50
I.....		60.00
K.....		57.50
L.....		55.00
If B. B. is omitted deduct \$10.80		

No. 6541¹/₂

Die.....	1.0 x 0. 6 x 2. 6..	1. 3
Base.....	1.4 x 0.10 x 0. 6..	0. 7
B. Base....	1.8 x 1. 2 x 0.10..	1. 7
Weight complete 615 lbs.; no B. B. 330 lbs.		
C.....		\$48.50
D.....		44.50
F.....		42.50
G.....		41.75
H.....		40.75
I.....		39.75
K.....		38.50
L.....		37.00
If B. B. is omitted deduct \$5.70		

No. 6542

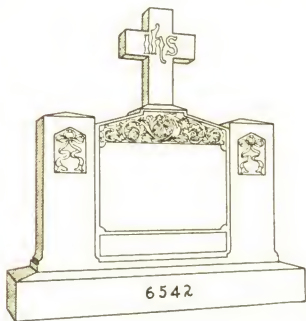

Cross.....1. 3 x 0.5 x 1.6..0. 9
 Die.....3. 4 x 1.0 x 2.2..7. 3
 B. Base....3.10 x 1.6 x 0.6..2.11
 Weight complete 1965 lbs.; no B.B.1440 lbs.

- C.....\$184.00
- D.....166.00
- F.....158.00
- G.....154.00
- H.....150.00
- I.....146.00
- K.....140.00
- L.....134.00

If B. B. is omitted deduct \$10.50

No. 6542¹/₄

Cross.....1. 0 x 0.4 x 1.4..0.5
 Die.....3. 4 x 0.10 x 2.2..6.0
 B. Base....3.10 x 1.4 x 0.6..2.7
 Weight complete 1620 lbs.; no B.B.1155 lbs.

- C.....\$157.00
- D.....142.00
- F.....136.00
- G.....133.00
- H.....129.00
- I.....126.00
- K.....121.00
- L.....117.00

If B. B. is omitted deduct \$9.30

No. 6542¹/₂

Cross.....1. 0 x 0.4 x 1.4..0. 5
 Die.....3. 4 x 0.8 x 2.2..4.10
 B. Base....3.10 x 1.2 x 0.6..2. 3
 Weight complete 1345 lbs.; no B. B. 945 lbs.

- C.....\$138.00
- D.....127.00
- F.....121.00
- G.....119.00
- H.....116.00
- I.....114.00
- K.....110.00
- L.....106.00

If B. B. is omitted deduct \$8.10

No. 6543



Cross.....1.2 x 0.5 x 1.6..0. 9
 Die.....1.8 x 0.10 x 2.10..3.11
 Base.....2.0 x 1.2 x 0.8..1. 7
 B. Base....2.6 x 1.8 x 1.0..4. 2
 Weight complete 1875 lbs.; no B.B.1125 lbs.

- G.....\$137.00
- H.....134.00
- I.....131.00
- K.....126.00
- L.....121.00

If B. B. is omitted deduct \$14.60

No. 6543¹/₄

Cross.....1. 0 x 0.4 x 1.4..0.5
 Die.....1.6 x 0.8 x 2.8..2.8
 Base.....1.10 x 1.0 x 0.8..1.3
 B. Base....2.4 x 1.6 x 1.0..3.6
 Weight complete 1410 lbs.; no B. B. 780 lbs.

- G.....\$107.00
- H.....105.00
- I.....102.00
- K.....99.00
- L.....96.00

If B. B. is omitted deduct \$12.25

No. 6543¹/₂

Cross.....0.10 x 0.3 x 1.2..0. 3
 Die.....1.4 x 0.6 x 2.6..1. 8
 Base.....1.8 x 0.10 x 0.6..0. 8
 B. Base....2.2 x 1.4 x 1.0..2.11
 Weight complete 990 lbs.; no B. B. 465 lbs.

- G.....\$85.50
- H.....84.00
- I.....83.00
- K.....81.00
- L.....79.00

If B. B. is omitted deduct \$10.50

No. 6543³/₄

Cross.....0.10 x 0.3 x 1.2..0.3
 Die.....1.2 x 0.6 x 2.6..1.6
 Base.....1.6 x 0.10 x 0.6..0.8
 B. Base....2.0 x 1.4 x 1.0..2.8
 Weight complete 915 lbs.; no B. B. 435 lbs.

- G.....\$79.50
- H.....78.50
- I.....77.00
- K.....75.50
- L.....73.50

If B. B. is omitted deduct \$9.60

No. 6544

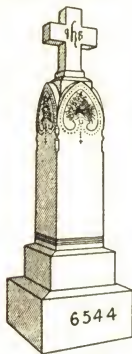

Cross.....1.2 x 0.5 x 1. 6. .0. 9
 Die.....1.2 x 1.2 x 3. 4. .4. 6
 Base.....1.6 x 1.6 x 0.10. .1.11
 B. Base....2.0 x 2.0 x 1. 0. .4. 0
 Weight complete 2010 lbs.; no B.B.1290 lbs.
 G.....\$113.00
 H.....109.00
 I.....106.00
 K.....100.00
 L.....95.00
 If B. B. is omitted deduct \$14.00

No. 6544¹/₄

Cross.....1. 0 x 0. 5 x 1.4. .0.7
 Die.....1. 0 x 1. 0 x 3.2. .3.2
 Base.....1. 4 x 1. 4 x 0.8. .1.2
 B. Base....1.10 x 1.10 x 1.0. .3.4
 Weight complete 1485 lbs.; no B. B. 885 lbs.
 G.....\$83.50
 H.....81.00
 I.....78.50
 K.....75.00
 L.....71.50
 If B. B. is omitted deduct \$11.65

No. 6544¹/₂

Cross....0.10 x 0. 4 x 1. 2. .0. 4
 Die.....0.10 x 0.10 x 3. 0. .2. 1
 Base.....1. 2 x 1. 2 x 0. 8. .0.11
 B. Base....1. 6 x 1. 6 x 0.10. .1.11
 Weight complete 945 lbs.; no B. B. 600 lbs.
 G.....\$61.50
 H.....60.00
 I.....58.50
 K.....56.00
 L.....53.50
 If B. B. is omitted deduct \$6.90

No. 6544³/₄

Cross.....0.8 x 0.3 x 1. 0. .0.2
 Die.....0.8 x 0.8 x 2. 8. .1.2
 Base.....1.0 x 1.0 x 0. 6. .0.6
 B. Base....1.4 x 1.4 x 0.10. .1.6
 Weight complete 600 lbs.; no B. B. 330 lbs.
 G.....\$40.75
 H.....39.75
 I.....38.75
 K.....37.50
 L.....36.00
 If B. B. is omitted deduct \$5.40

No. 6546

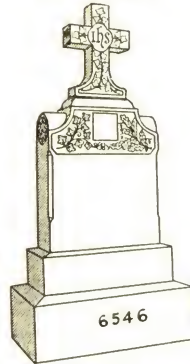

Cross.....1.4 x 0. 5 x 1.10. .1.0
 Die.....2.4 x 0.10 x 2.10. .5.6
 Base.....2.8 x 1. 2 x 0. 8. .2.1
 B. Base....3.2 x 1. 8 x 1. 2. .6.2
 Weight complete 2500 lbs.; no B.B.1400 lbs.
 C.....\$167.00
 D.....147.00
 F.....139.00
 G.....134.00
 H.....130.00
 I.....126.00
 K.....119.00
 L.....113.00
 If B. B. is omitted deduct \$21.60

No. 6546¹/₄

Cross.....1.2 x 0.4 x 1.8. .0. 8
 Die.....2.2 x 0.8 x 2.8. .3.10
 Base.....2.6 x 1.0 x 0.8. .1. 8
 B. Base....3.0 x 1.6 x 1.0. .4. 6
 Weight complete 1850 lbs.; no B.B.1050 lbs.
 C.....\$125.00
 D.....111.00
 F.....105.00
 G.....102.00
 H.....99.00
 I.....95.50
 K.....91.00
 L.....86.50
 If B. B. is omitted deduct \$15.75

No. 6546¹/₂

Cross.....1. 0 x 0. 3 x 1.4. .0. 4
 Die.....1.10 x 0. 6 x 2.6. .2. 4
 Base.....2. 2 x 0.10 x 0.6. .0.11
 B. Base....2. 8 x 1. 4 x 1.0. .3. 7
 Weight complete 1200 lbs.; no B. B. 575 lbs.
 C.....\$84.00
 D.....76.00
 F.....72.00
 G.....70.50
 H.....68.50
 I.....67.00
 K.....64.00
 L.....61.50
 If B. B. is omitted deduct \$12.55

No. 6547

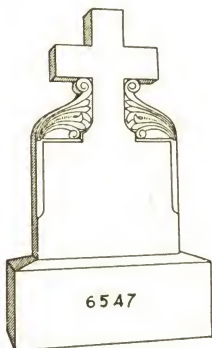

Cross.....1.6 x 0. 4 x 2.10..1.5
 B. Base....2.0 x 0.10 x 0.10..1.5
 Weight complete 475 lbs.; no B. B. 220 lbs.

C.....	\$42.75
D.....	39.50
F.....	38.00
G.....	37.25
H.....	36.50
I.....	36.00
K.....	34.75
L.....	33.75

If B. B. is omitted deduct \$5.10
 Face only polished; balance sand finished

No. 6547¹/₄

Cross.....1.4 x 0.4 x 2. 6..1.1
 B. Base....1.9 x 0.9 x 0.10..1.1
 Weight complete 375 lbs.; no B. B. 180 lbs.

C.....	\$34.75
D.....	32.25
F.....	31.25
G.....	30.75
H.....	30.00
I.....	29.50
K.....	28.75
L.....	28.00

If B. B. is omitted deduct \$3.90
 Face only polished; balance sand finished

No. 6547¹/₂

Cross.....1.4 x 0.3 x 2.6..0.10
 B. Base....1.9 x 0.8 x 0.8..0. 9
 Weight complete 250 lbs.; no B. B. 115 lbs.

C.....	\$28.00
D.....	26.25
F.....	25.25
G.....	25.00
H.....	24.50
I.....	24.25
K.....	23.50
L.....	22.75

If B. B. is omitted deduct \$2.80
 Face only polished; balance sand finished

No. 6548

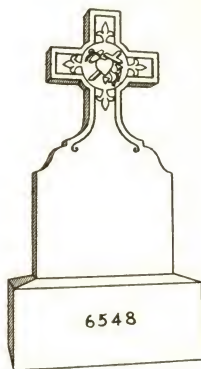

Cross.....1.6 x 0. 4 x 2.10..1.5
 B. Base....2.0 x 0.10 x 0.10..1.5
 Weight complete 475 lbs.; no B. B. 220 lbs.

C.....	\$42.75
D.....	39.50
F.....	38.00
G.....	37.25
H.....	36.50
I.....	36.00
K.....	34.75
L.....	33.75

If B. B. is omitted deduct \$5.10
 Face only polished; balance sand finished

No. 6548¹/₄

Cross.....1.4 x 0.4 x 2. 8..1.2
 B. Base....1.9 x 0.9 x 0.10..1.1
 Weight complete 375 lbs.; no B. B. 180 lbs.

C.....	\$34.00
D.....	31.50
F.....	30.50
G.....	30.00
H.....	29.25
I.....	28.75
K.....	28.00
L.....	27.25

If B. B. is omitted deduct \$3.90
 Face only polished; balance sand finished

No. 6548¹/₂

Cross.....1.4 x 0.3 x 2.8..0.11
 B. Base....1.9 x 0.8 x 0.8..0. 9
 Weight complete 275 lbs.; no B. B. 140 lbs.

C.....	\$27.75
D.....	26.00
F.....	25.00
G.....	24.75
H.....	24.25
I.....	24.00
K.....	23.25
L.....	22.50

If B. B. is omitted deduct \$2.80
 Face only polished; balance sand finished

No. 6549

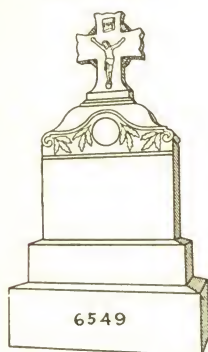

Cross.....1. 2 x 0.6 x 1.10..1. 1
 Die.....2. 6 x 1.2 x 2. 8..7. 9
 Base.....2.10 x 1.6 x 0. 8..2.10
 B. Base....3. 6 x 2.2 x 1. 2..8.10
 Weight complete 3690 lbs.; no B.B.2100 lbs.

C.....	\$254.00
D.....	228.00
F.....	216.00
G.....	210.00
H.....	205.00
I.....	199.00
K.....	190.00
L.....	181.00

If B. B. is omitted deduct \$30.90

No. 6549¹/₄

Cross.....1.2 x 0. 5 x 1.8..0.10
 Die.....2.4 x 1. 0 x 2.6..5.10
 Base.....2.8 x 1. 4 x 0.8..2. 4
 B. Base....3.2 x 1.10 x 1.2..6. 9
 Weight complete 2835 lbs.; no B.B.1620 lbs.

C.....	\$203.00
D.....	183.00
F.....	174.00
G.....	169.00
H.....	165.00
I.....	160.00
K.....	153.00
L.....	147.00

If B. B. is omitted deduct \$23.65

No. 6549¹/₂

Cross.....1.1 x 0. 5 x 1.6..0. 8
 Die.....2.2 x 0.10 x 2.4..4. 3
 Base.....2.6 x 1. 2 x 0.8..1.11
 B. Base....3.0 x 1. 8 x 1.0..5. 0
 Weight complete 2130 lbs.; no B.B.1230 lbs.

C.....	\$161.00
D.....	145.00
F.....	139.00
G.....	135.00
H.....	132.00
I.....	128.00
K.....	123.00
L.....	118.00

If B. B. is omitted deduct \$17.50

No. 6550

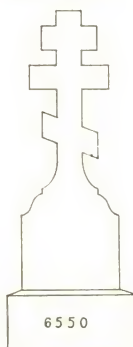

Cross.....1.6 x 0.6 x 4. 4..3.3
 B. Base....2.0 x 1.0 x 0.10..1.8
 Weight complete 750 lbs.; no B. B. 450 lbs.

C.....	\$75.00
D.....	67.50
F.....	64.50
G.....	63.00
H.....	61.00
I.....	59.50
K.....	57.00
L.....	54.50

If B. B. is omitted deduct \$6.00
 Face only polished; balance sand finished

No. 6550¹/₄

Cross.....1.6 x 0. 4 x 4. 0..2.0
 B. Base....2.0 x 0.10 x 0.10..1.5
 Weight complete 550 lbs.; no B. B. 295 lbs.

C.....	\$53.00
D.....	48.25
F.....	46.25
G.....	45.25
H.....	44.25
I.....	43.25
K.....	41.75
L.....	40.25

If B. B. is omitted deduct \$5.10
 Face only polished; balance sand finished

No. 6550¹/₂

Cross.....1.4 x 0.4 x 3.10..1.8
 B. Base....1.9 x 0.9 x 0.10..1.1
 Weight complete 425 lbs.; no B. B. 230 lbs.

C.....	\$46.00
D.....	42.25
F.....	40.75
G.....	39.75
H.....	39.00
I.....	38.25
K.....	37.00
L.....	35.75

If B. B. is omitted deduct \$3.90
 Face only polished; balance sand finished

No. 6551

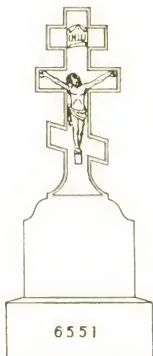

Cross.....1.6 x 0.6 x 4. 4. 3.3
 B. Base.....2.0 x 1.0 x 0.10..1.8
 Weight complete 750 lbs.; no B. B. 450 lbs.

C.....	\$77.50
D.....	70.00
F.....	67.00
G.....	65.50
H.....	63.50
I.....	62.00
K.....	59.00
L.....	57.00

If B. B. is omitted deduct \$6.00
 Face only polished; balance sand finished

No. 6551¹/₄

Cross.....1.6 x 0. 4 x 4. 0. 2.0
 B. Base.....2.0 x 0.10 x 0.10..1.5
 Weight complete 550 lbs.; no B. B. 295 lbs.

C.....	\$55.50
D.....	51.00
F.....	48.75
G.....	47.75
H.....	46.75
I.....	45.75
K.....	44.25
L.....	42.75

If B. B. is omitted deduct \$5.10
 Face only polished; balance sand finished

No. 6551¹/₂

Cross.....1.4 x 0.4 x 3.10..1.8
 B. Base.....1.9 x 0.9 x 0.10..1.1
 Weight complete 425 lbs.; no B. B. 230 lbs.

C.....	\$48.50
D.....	44.75
F.....	43.25
G.....	42.25
H.....	41.50
I.....	40.75
K.....	39.50
L.....	38.25

If B. B. is omitted deduct \$3.90
 Face only polished; balance sand finished

No. 6552

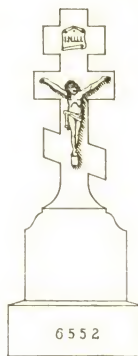

Cross.....1.6 x 0.6 x 4. 4. 3.3
 B. Base.....2.0 x 1.0 x 0.10..1.8
 Weight complete 750 lbs.; no B. B. 450 lbs.

C.....	\$98.00
D.....	90.50
F.....	87.50
G.....	86.00
H.....	84.00
I.....	82.50
K.....	80.00
L.....	77.50

If B. B. is omitted deduct \$6.00
 Face only polished; balance sand finished

No. 6552¹/₄

Cross.....1.6 x 0. 4 x 4. 0. 2.0
 B. Base.....2.0 x 0.10 x 0.10..1.5
 Weight complete 550 lbs.; no B. B. 295 lbs.

C.....	\$71.00
D.....	66.50
F.....	64.50
G.....	63.50
H.....	62.50
I.....	61.50
K.....	60.00
L.....	58.50

If B. B. is omitted deduct \$5.10
 Face only polished; balance sand finished

No. 6552¹/₂

Cross.....1.4 x 0.4 x 3 10..1.8
 B. Base.....1.9 x 0 9 x 0.10..1.1
 Weight complete 425 lbs.; no B. B. 230 lbs.

C.....	\$64.00
D.....	60.50
F.....	58.50
G.....	58.00
H.....	57.00
I.....	56.00
K.....	55.00
L.....	53.50

If B. B. is omitted deduct \$3.90
 Face only polished; balance sand finished

No. 6553

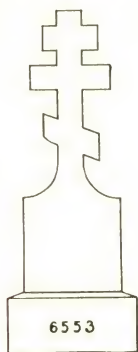

Cross.....1.6 x 0.6 x 4. 4. 3.3
 B. Base.....2.0 x 1.0 x 0.10. 1.8
 Weight complete 750 lbs.; no B. B. 450 lbs.

C.....	\$75.00
D.....	67.50
F.....	64.50
G.....	63.00
H.....	61.00
I.....	59.50
K.....	57.00
L.....	54.50

If B. B. is omitted deduct \$6.00
 Face only polished; balance sand finished

No. 6553¹/₄

Cross.....1.6 x 0. 4 x 4. 0. 2.0
 B. Base.....2.0 x 0.10 x 0.10. 1.5
 Weight complete 550 lbs.; no B. B. 295 lbs.

C.....	\$53.00
D.....	48.25
F.....	46.25
G.....	45.25
H.....	44.25
I.....	43.25
K.....	41.75
L.....	40.25

If B. B. is omitted deduct \$5.10
 Face only polished; balance sand finished

No. 6553¹/₂

Cross.....1.4 x 0.4 x 3.10. 1.8
 B. Base.....1.9 x 0.9 x 0.10. 1.1
 Weight complete 425 lbs.; no B. B. 230 lbs.

C.....	\$46.00
D.....	42.25
F.....	40.75
G.....	39.75
H.....	39.00
I.....	38.25
K.....	37.00
L.....	35.75

If B. B. is omitted deduct \$3.90
 Face only polished; balance sand finished

No. 6554

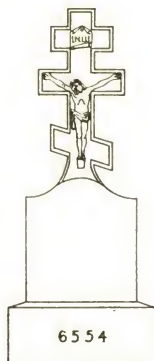

Cross.....1.6 x 0.6 x 4. 4. 3.3
 B. Base.....2.0 x 1.0 x 0.10. 1.8
 Weight complete 750 lbs.; no B. B. 450 lbs.

C.....	\$77.50
D.....	70.00
F.....	67.00
G.....	65.50
H.....	63.50
I.....	62.00
K.....	59.00
L.....	57.00

If B. B. is omitted deduct \$6.00
 Face only polished; balance sand finished

No. 6554¹/₄

Cross.....1.6 x 0. 4 x 4. 0. 2.0
 B. Base.....2.0 x 0.10 x 0.10. 1.5
 Weight complete 550 lbs.; no B. B. 295 lbs.

C.....	\$55.50
D.....	51.00
F.....	48.75
G.....	47.75
H.....	46.75
I.....	45.75
K.....	44.25
L.....	42.75

If B. B. is omitted deduct \$5.10
 Face only polished; balance sand finished

No. 6554¹/₂

Cross.....1.4 x 0.4 x 3.10. 1.8
 B. Base.....1.9 x 0.9 x 0.10. 1.1
 Weight complete 425 lbs.; no B. B. 230 lbs.

C.....	\$48.50
D.....	44.75
F.....	43.25
G.....	42.25
H.....	41.50
I.....	40.75
K.....	39.50
L.....	38.25

If B. B. is omitted deduct \$3.90
 Face only polished; balance sand finished

No. 6555

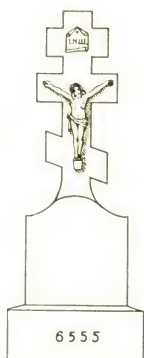

Cross.....1.6 x 0.6 x 4. 4..3.3
 B. Base.....2.0 x 1.0 x 0.10..1.8
 Weight complete 750 lbs.; no B. B. 450 lbs.

C.....	\$98.00
D.....	90.50
F.....	87.50
G.....	86.00
H.....	84.00
I.....	82.50
K.....	80.00
L.....	77.50

If B. B. is omitted deduct \$6.00
 Face only polished; balance sand finished

No. 6555¹/₄

Cross.....1.6 x 0.4 x 4. 0..2.0
 B. Base.....2.0 x 0.10 x 0.10..1.5
 Weight complete 550 lbs.; no B. B. 295 lbs.

C.....	\$71.00
D.....	66.50
F.....	64.50
G.....	63.50
H.....	62.50
I.....	61.50
K.....	60.00
L.....	58.50

If B. B. is omitted deduct \$5.10
 Face only polished; balance sand finished

No. 6555¹/₂

Cross.....1.4 x 0.4 x 3.10..1.8
 B. Base.....1.9 x 0.9 x 0.10..1.1
 Weight complete 425 lbs.; no B. B. 230 lbs.

C.....	\$64.00
D.....	60.50
F.....	58.50
G.....	58.00
H.....	57.00
I.....	56.00
K.....	55.00
L.....	53.50

If B. B. is omitted deduct \$3.90
 Face only polished; balance sand finished

No. 6556

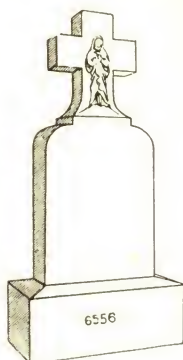

Cross.....1.8 x 0.8 x 3.10..4.3
 B. Base.....2.2 x 1.2 x 1. 0..2.6
 Weight complete 1050 lbs.; no B. B. 600 lbs.

C.....	\$116.00
D.....	106.00
F.....	102.00
G.....	100.00
H.....	97.50
I.....	95.50
K.....	92.50
L.....	89.00

If B. B. is omitted deduct \$9.00
 All polished. If face only is polished deduct \$4.50.

No. 6556¹/₄

Cross.....1.6 x 0.6 x 3. 6..2.8
 B. Base.....2.0 x 1.0 x 0.10..1.8
 Weight complete 675 lbs.; no B. B. 375 lbs.

C.....	\$83.50
D.....	77.50
F.....	74.50
G.....	73.50
H.....	72.00
I.....	70.50
K.....	68.50
L.....	66.50

If B. B. is omitted deduct \$6.00
 All polished. If face only is polished deduct \$3.50.

No. 6557

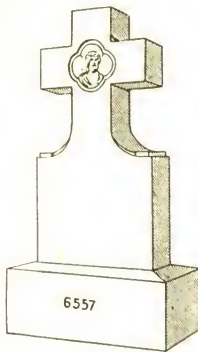

Cross.....1.8 x 0.8 x 3.6 .3.11
 B. Base.....2.2 x 1.2 x 1.0 .2. 6
 Weight complete 1000 lbs.; no B. B. 550 lbs.

C.....	\$104.00
D.....	95.50
F.....	91.50
G.....	89.50
H.....	87.50
I.....	85.50
K.....	82.50
L.....	80.00

If B. B. is omitted deduct \$9.00
 Face only polished; balance sand finished. If back is polished extra \$2.00.
 If back and edges are polished extra \$4.50.

No. 6557¹/₄

Cross.....1.6 x 0.6 x 3. 0. .2.3
 B. Base.....2.0 x 1.0 x 0.10 .1.8
 Weight complete 600 lbs.; no B. B. 300 lbs.

C.....	\$75.00
D.....	70.00
F.....	68.00
G.....	67.00
H.....	65.50
I.....	64.50
K.....	63.00
L.....	61.00

If B. B. is omitted deduct \$6.00
 Face only polished; balance sand finished. If back is polished extra \$1.75.
 If back and edges are polished extra \$3.50.

No. 6560

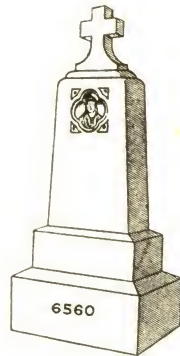

Cross.....1. 0 x 0. 4 x 1. 2 .0.5
 Die.....1.10 x 0.10 x 2.10 .4.4
 Base.....2. 2 x 1. 2 x 0. 8 .1.8
 B. Base.....2.10 x 1.10 x 1. 0 .5.2
 Weight complete 1900 lbs.; no B. B. 970 lbs.

C.....	\$168.00
D.....	153.00
F.....	147.00
G.....	144.00
H.....	140.00
I.....	137.00
K.....	132.00
L.....	128.00

If B. B. is omitted deduct \$18.10

No. 6560¹/₄

Cross.....0.10 x 0.3 x 1.0 .0.3
 Die.....1. 6 x 0.8 x 2.6 .2.6
 Base.....1.10 x 1.0 x 0.8 .1.3
 B. Base.....2. 4 x 1.6 x 1.0 .3.6
 Weight complete 1200 lbs.; no B. B. 570 lbs.

C.....	\$125.00
D.....	116.00
F.....	112.00
G.....	110.00
H.....	108.00
I.....	106.00
K.....	103.00
L.....	100.00

If B. B. is omitted deduct \$12.25

No. 6560¹/₂

Cross.....0.10 x 0. 3 x 1.0 .0. 3
 Die.....1. 6 x 0. 6 x 2.6 .1.11
 Base.....1.10 x 0.10 x 0.6 .0. 9
 B. Base.....2. 4 x 1. 4 x 1.0 .3. 1
 Weight complete 1000 lbs.; no B. B. 445 lbs.

C.....	\$106.00
D.....	99.00
F.....	96.00
G.....	94.50
H.....	93.00
I.....	91.50
K.....	89.50
L.....	87.50

If B. B. is omitted deduct \$10.80

No. 6561

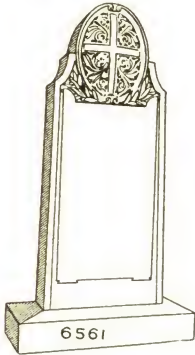

Die.....2.4 x 1.0 x 5.6..12.10
 B. Base...3.4 x 1.10 x 0.8.. 4. 1
 Weight complete 2800 lbs.; no B. B. 2075 lbs.

C.....	\$322.00
D.....	293.00
F.....	281.00
G.....	274.00
H.....	268.00
I.....	261.00
K.....	252.00
L.....	242.00

If B. B. is omitted deduct \$14.30

No. 6561¹/₄

Die.....2.4 x 0.10 x 5.6..10.8
 B. Base...3.4 x 1.8 x 0.8.. 3.8
 Weight complete 2400 lbs.; no B. B. 1560 lbs.

C.....	\$286.00
D.....	262.00
F.....	252.00
G.....	246.00
H.....	241.00
I.....	236.00
K.....	228.00
L.....	220.00

If B. B. is omitted deduct \$12.85

No. 6561¹/₂

Die.....2.4 x 0.8 x 5.6..8.7
 B. Base...3.4 x 1.6 x 0.8..3.4
 Weight complete 2000 lbs.; no B. B. 1400 lbs.

C.....	\$253.00
D.....	233.00
F.....	225.00
G.....	220.00
H.....	216.00
I.....	212.00
K.....	205.00
L.....	199.00

If B. B. is omitted deduct \$11.65

No. 6562

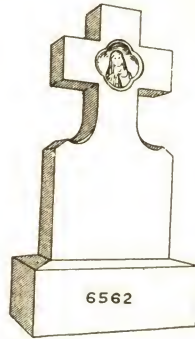

Cross.....1.8 x 0.8 x 3.6..3.11
 B. Base....2.2 x 1.2 x 1.0..2.6
 Weight complete 975 lbs.; no B. B. 525 lbs.

C.....	\$100.00
D.....	91.00
F.....	87.00
G.....	85.00
H.....	83.00
I.....	81.00
K.....	78.00
L.....	75.50

If B. B. is omitted deduct \$9.00
 Face polished; balance sand finished

No. 6562¹/₄

Cross.....1.6 x 0.6 x 3.0..2.3
 B. Base....2.0 x 1.0 x 0.10..1.8
 Weight complete 600 lbs.; no B. B. 300 lbs.

C.....	\$70.00
D.....	65.00
F.....	63.00
G.....	62.00
H.....	60.50
I.....	59.50
K.....	58.00
L.....	56.00

If B. B. is omitted deduct \$6.00
 Face polished; balance sand finished

No. 6563

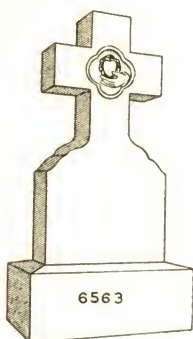

Cross.....1.8 x 0.8 x 3.6..3.11
 B. Base.....2.2 x 1.2 x 1.0..2.6
 Weight complete 975 lbs.; no B. B. 525 lbs.

C.....	\$98.50
D.....	89.50
F.....	85.50
G.....	83.50
H.....	81.50
I.....	79.50
K.....	76.50
L.....	74.00

If B. B. is omitted deduct \$9.00
 Face only polished; balance sand finished

No. 6564

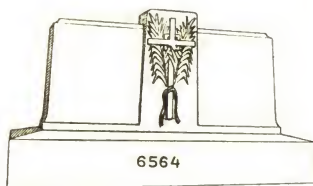

Die.....4. 0 x 1.0 x 2. 0..8.0
 B. Base....4.10 x 1.8 x 0.10..6.9
 Weight complete 2400 lbs.; no B. B.1185 lbs.

C.....	\$213.00
D.....	195.00
F.....	187.00
G.....	183.00
H.....	179.00
I.....	175.00
K.....	169.00
L.....	163.00

If B. B. is omitted deduct \$23.65
 Sand finished

No. 6564¹/₄

Die.....4. 0 x 0.10 x 2. 0..6.8
 B. Base....4.10 x 1.6 x 0.10..6.1
 Weight complete 2075 lbs.; no B. B. 980 lbs.

C.....	\$187.00
D.....	172.00
F.....	166.00
G.....	162.00
H.....	159.00
I.....	156.00
K.....	151.00
L.....	146.00

If B. B. is omitted deduct \$21.30
 Sand finished

No. 6563¹/₄

Cross.....1.6 x 0.6 x 3. 0..2.3
 B. Base.....2.0 x 1.0 x 0.10..1.8
 Weight complete 600 lbs.; no B. B. 300 lbs.

C.....	\$69.00
D.....	64.00
F.....	62.00
G.....	61.00
H.....	59.50
I.....	58.50
K.....	57.00
L.....	55.00

If B. B. is omitted deduct \$6.00
 Face only polished; balance sand finished

No. 6564¹/₂

Die.....4. 0 x 0.8 x 2. 0..5.4
 B. Base....4.10 x 1.2 x 0.10..4.8
 Weight complete 1800 lbs.; no B. B. 960 lbs.

C.....	\$166.00
D.....	154.00
F.....	148.00
G.....	146.00
H.....	143.00
I.....	140.00
K.....	136.00
L.....	132.00

If B. B. is omitted deduct \$16.35
 Sand finished

No. 6565

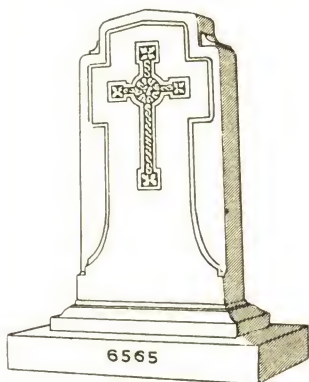

Die.....2.6 x 1.0 x 4.6 .11 3
 Base.....3.4 x 1.6 x 0.6 .2 6
 B.Ba. (S.S.) .4.2 x 2.2 x 1.0 . 9.0
 Weight complete 3800 lbs.

D.....	\$373.00
F.....	359.00
G.....	352.00
H.....	345.00
I.....	339.00
K.....	328.00
L.....	318.00

No. 6565¹/₄

Die.....2.6 x 0.10 x 4. 6 .9. 5
 Base.....3.4 x 1. 4 x 0. 6 .2. 3
 B.Ba. (S.S.) .4.2 x 2. 0 x 0.10 .6.11
 Weight complete 3200 lbs.

D.....	\$336.00
F.....	324.00
G.....	318.00
H.....	313.00
I.....	306.00
K.....	298.00
L.....	289.00

No. 6565¹/₂

Die.....2.6 x 0. 8 x 4. 6 .7. 6
 Base.....3.4 x 1. 2 x 0. 6 .1.11
 B.Ba. (S.S.) .4.2 x 1.10 x 0.10 .6. 4
 Weight complete 2700 lbs.

D.....	\$298.00
F.....	288.00
G.....	284.00
H.....	279.00
I.....	274.00
K.....	267.00
L.....	260.00

No. 6566



Cross.....2.2 x 0. 6 x 6.2 .6. 8
 Base.....2.4 x 1. 8 x 0.6 .1.11
 B.Ba. (S.S.) .3.6 x 2.10 x 0.6 .5. 0
 Weight complete 1800 lbs.

D.....	\$361.00
F.....	353.00
G.....	348.00
H.....	344.00
I.....	340.00
K.....	333.00
L.....	327.00

"M. M." finish

No. 6567

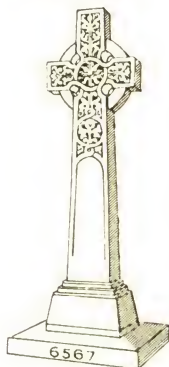

Cross.....2.4 x 0.8 x 6.10 .10.8
 Die.....2.0 x 1.6 x 1. 4 .4 .0
 B.Ba. (S.S.) .3.4 x 2.8 x 0. 6 . 4.5
 Weight complete 2500 lbs.

D.....	\$454.00
F.....	440.00
G.....	432.00
H.....	425.00
I.....	418.00
K.....	407.00
L.....	396.00

"M. M." finish

No. 6568



Cross.....	3.1 x 0.10 x 9. 2. .23. 6
Base.....	3.0 x 2. 2 x 0.10.. 5. 5
B.Ba. (S.S.)	4.8 x 3. 6 x 0. 8. .10.11

Weight complete 6000 lbs.

D.....	\$873.00
F.....	845.00
G.....	830.00
H.....	816.00
I.....	801.00
K.....	779.00
L.....	758.00

"M. M." finish

No. 6569

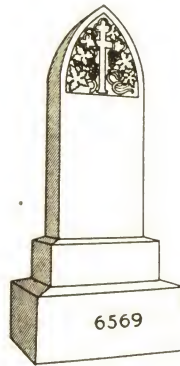

Die.....	1.4 x 0.10 x 3.6.. 3.11
Base.....	1.8 x 1. 2 x 0.8.. 1. 4
B. Base.....	2.2 x 1. 8 x 1.0.. 3. 7

Weight complete 1500 lbs.; no B. B. 855 lbs.

D.....	\$128.00
F.....	122.00
G.....	120.00
H.....	117.00
I.....	115.00
K.....	111.00
L.....	107.00

If B. B. is omitted deduct \$12 55

No. 6569¹/₄

Die.....	1.4 x 0.8 x 3.6.. 3.1
Base.....	1.8 x 1.0 x 0.8.. 1.1
B. Base.....	2.2 x 1.6 x 1.0.. 3.3

Weight complete 1300 lbs.; no B. B. 715 lbs.

D.....	\$111.00
F.....	107.00
G.....	105.00
H.....	103.00
I.....	101.00
K.....	97.50
L.....	94.50

If B. B. is omitted deduct \$11.40

No. 6569¹/₂

Die.....	1.4 x 0. 6 x 3. 6.. 2.4
Base.....	1.8 x 0.10 x 0. 6.. 0.8
B. Base.....	2.2 x 1. 4 x 0.10.. 2.5

Weight complete 950 lbs.; no B. B. 515 lbs.

D.....	\$94.50
F.....	91.50
G.....	90.00
H.....	88.50
I.....	87.00
K.....	85.00
L.....	82.50

If B. B. is omitted deduct \$8.70

No. 6569¹/₂

See previous column

No. 6570

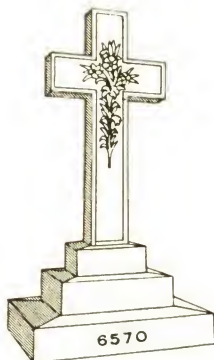

Cross.....3.0 x 0.9 x 5.10..13.2
 Base.....1.9 x 1.3 x 0.8.. 1.6
 Base.....2.9 x 2.0 x 0.9.. 4.2
 B.Ba. (S.S.) .4.4 x 3.2 x 0.10..11.5

Weight complete 4800 lbs.

D.....\$439.00
 F..... 421.00
 G..... 411.00
 H..... 402.00
 I..... 392.00
 K..... 378.00
 L..... 364.00

Sand finished

No. 6571

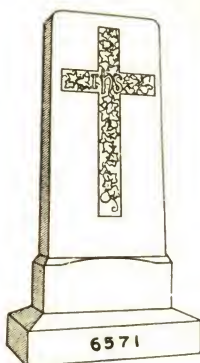

Die.....2.4 x 0.10 x 4.6..8.9
 Base.....2.6 x 1.0 x 1.0..2.6
 B.Ba. (S.S.) .3.4 x 1.10 x 0.10..5.1

Weight complete 2750 lbs.

D.....\$271.00
 F..... 259.00
 G..... 254.00
 H..... 248.00
 I..... 243.00
 K..... 234.00
 L..... 226.00

Hone finished

No. 6572³/₄

Cross.....1.0 x 0.4 x 1.6..0.6
 Die.....3.6 x 0.8 x 2.8..6.3
 B. Ba. (S.S.) .4.6 x 1.6 x 1.0..6.9

Weight complete 2325 lbs.

D.....\$183.00
 F..... 177.00
 G..... 173.00
 H..... 170.00
 I..... 167.00
 K..... 161.00
 L..... 156.00

"M. M." finish

No. 6571¹/₄

Die.....2.4 x 0.8 x 4.6..7.0
 Base.....2.6 x 0.10 x 0.10..1.9
 B.Ba. (S.S.) .3.4 x 1.6 x 0.10..4.2

Weight complete 2150 lbs.

D.....\$237.00
 F..... 229.00
 G..... 224.00
 H..... 220.00
 I..... 216.00
 K..... 209.00
 L..... 202.00

Hone finished

No. 6572

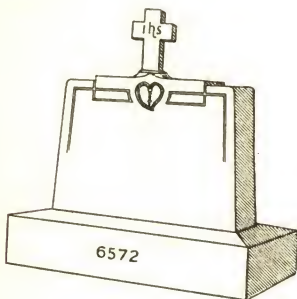

Cross.....1.4 x 0.7 x 1.10.. 1.5
 Die.....4.0 x 1.2 x 3.0..14.0
 B.Ba. (S.S.)..5.0 x 2.0 x 1.2..11.8
 Weight complete 4600 lbs.

D.....	\$323.00
F.....	307.00
G.....	300.00
H.....	292.00
I.....	284.00
K.....	273.00
L.....	261.00

"M. M." finish

No. 6572¹/₄

Cross.....1.2 x 0.6 x 1.8..1.0
 Die.....3.6 x 1.0 x 2.8..9.4
 B. Ba. (S.S.)..4.6 x 1.10 x 1.0..8.3
 Weight complete 3100 lbs.

D.....	\$241.00
F.....	231.00
G.....	226.00
H.....	221.00
I.....	215.00
K.....	208.00
L.....	200.00

"M. M." finish

No. 6572¹/₂

Cross.....1.0 x 0.5 x 1.6..0.8
 Die.....3.6 x 0.10 x 2.8..7.9
 B. Ba. (S.S.)..4.6 x 1.8 x 1.0..7.6
 Weight complete 2725 lbs.

D.....	\$210.00
F.....	202.00
G.....	198.00
H.....	193.00
I.....	189.00
K.....	183.00
L.....	177.00

"M. M." finish

No. 6572³/₄

See previous page

No. 6573

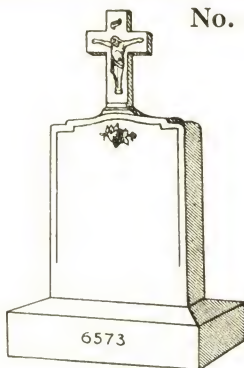

Cross.....1.2 x 0.6 x 1.8.. 1.0
 Die.....3.0 x 1.0 x 4.0..12.0
 B.Ba. (S.S.)..4.0 x 1.10 x 1.0.. 7.4
 Weight complete 3500 lbs.

D.....	\$271.00
F.....	259.00
G.....	252.00
H.....	246.00
I.....	239.00
K.....	229.00
L.....	220.00

"M. M." finish

No. 6573¹/₄

Cross.....1.2 x 0.5 x 1.8..0.10
 Die.....3.0 x 0.10 x 4.0..10.0
 B.Ba. (S.S.)..4.0 x 1.8 x 1.0.. 6.8
 Weight complete 3000 lbs.

D.....	\$239.00
F.....	229.00
G.....	223.00
H.....	218.00
I.....	212.00
K.....	204.00
L.....	196.00

"M. M." finish

No. 6573¹/₂

Cross.....1.2 x 0.5 x 1.8..0.10
 Die.....2.8 x 0.10 x 3.6..7.9
 B.Ba. (S.S.)..3.8 x 1.6 x 1.0..5.6
 Weight complete 2400 lbs.

D.....	\$206.00
F.....	198.00
G.....	193.00
H.....	189.00
I.....	185.00
K.....	178.00
L.....	172.00

"M. M." finish

No. 6573³/₄

Cross.....1.2 x 0.4 x 1.8..0.8
 Die.....2.8 x 0.8 x 3.6..6.3
 B. Ba. (S.S.)..3.8 x 1.4 x 1.0..4.11
 Weight complete 2025 lbs.

D.....	\$181.00	I.....	164.00
F.....	175.00	K.....	159.00
G.....	171.00	L.....	154.00
H.....	168.00		

"M. M." finish

No. 6574

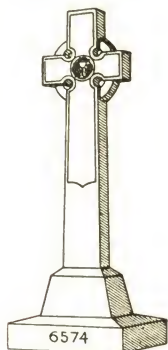

Cross.....2.8 x 0.11 x 6.10..16.8
 Die.....2.8 x 1.10 x 1. 6.. 7.4
 B. Ba. (S.S.)..3.8 x 2.10 x 0.10.. 8.8

Weight complete 5500 lbs.

D.....\$427.00
 F..... 403.00
 G..... 391.00
 H..... 379.00
 I..... 367.00
 K..... 349.00
 L..... 331.00

"M. M." finish

No. 6574¹/₄

Cross.....2.4 x 0.9 x 6.6..11.5
 Die.....2.4 x 1.6 x 1.4.. 4.8
 B. Ba. (S.S.)..3.4 x 2.6 x 0.8.. 5.7

Weight complete 3500 lbs.

D.....\$320.00
 F..... 304.00
 G..... 296.00
 H..... 288.00
 I..... 280.00
 K..... 268.00
 L..... 256.00

"M. M." finish

No. 6574¹/₂

Cross.....2.0 x 0.7 x 6.2..7.2
 Die.....2.0 x 1.4 x 1.2..3.1
 B. Ba. (S.S.)..3.0 x 2.4 x 0.8..4.8

Weight complete 2500 lbs.

D.....\$237.00
 F..... 227.00
 G..... 222.00
 H..... 217.00
 I..... 212.00
 K..... 204.00
 L..... 196.00

"M. M." finish

No. 6575

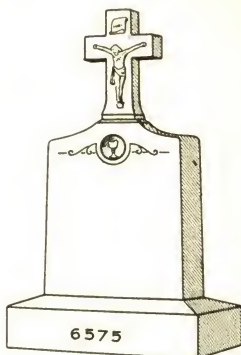

Cross.....1.4 x 0. 6 x 2.0..1.4
 Die.....2.6 x 1. 0 x 3.0..7.6
 B. Ba. (S.S.)..3.6 x 1.10 x 1.0..6.5

Weight complete 2500 lbs.

D.....\$199.00
 F..... 191.00
 G..... 186.00
 H..... 182.00
 I..... 177.00
 K..... 171.00
 L..... 164.00

"M. M." finish

No. 6575¹/₄

Cross.....1.4 x 0. 5 x 2.0..1. 1
 Die.....2.6 x 0.10 x 3.0..6. 3
 B. Ba. (S.S.)..3.6 x 1. 8 x 1.0..5.10

Weight complete 2200 lbs.

D.....\$174.00
 F..... 166.00
 G..... 163.00
 H..... 159.00
 I..... 155.00
 K..... 150.00
 L..... 144.00

"M. M." finish

No. 6575¹/₂

Cross.....1.4 x 0.4 x 1.10..0.10
 Die.....2.6 x 0.8 x 3. 0..5. 0
 B. Ba. (S.S.)..3.4 x 1.4 x 1. 0..4. 5

Weight complete 1700 lbs.

D.....\$152.00
 F..... 146.00
 G..... 143.00
 H..... 140.00
 I..... 137.00
 K..... 133.00
 L..... 129.00

"M. M." finish

No. 6576

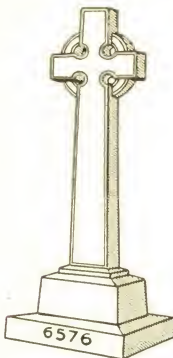

Cross.....2.6 x 0.10 x 6.0..12.6
 Die.....2.6 x 1.8 x 1.2..4.10
 B. Base....3.6 x 2.6 x 0.8..5.10

Weight complete 3600 lbs.; no B. B. 2550 lbs.

D.....\$331.00
 F.....313.00
 G.....305.00
 H.....296.00
 I.....287.00
 K.....274.00
 L.....261.00

If B. B. is omitted deduct \$20.40
 Grit finished

No. 6576 1/4

Cross.....2.0 x 0.8 x 5.6..7.4
 Die.....2.0 x 1.6 x 1.0..3.0
 B. Base....2.10 x 2.2 x 0.6..3.1

Weight complete 2100 lbs.; no B. B. 1550 lbs.

D.....\$235.00
 F.....225.00
 G.....220.00
 H.....215.00
 I.....209.00
 K.....202.00
 L.....194.00

If B. B. is omitted deduct \$10.80
 Grit finished

No. 6576 1/2

Cross.....1.9 x 0.6 x 5.2..4.6
 Die.....1.10 x 1.4 x 1.0..2.5
 B. Base....2.8 x 2.0 x 0.6..2.8

Weight complete 1650 lbs.; no B. B. 1170 lbs.

D.....\$180.00
 F.....174.00
 G.....170.00
 H.....167.00
 I.....163.00
 K.....158.00
 L.....153.00

If B. B. is omitted deduct \$9.60
 Grit finished

No. 6577

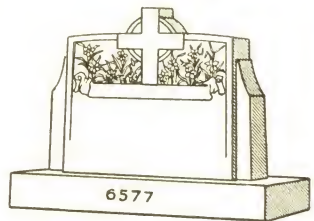

Die.....6.0 x 1.4 x 4.8..37.4
 B. Ba. (S.S.)..7.8 x 2.2 x 1.0..16.7

Weight complete 9650 lbs.

D.....\$728.00
 F.....690.00
 G.....672.00
 H.....653.00
 I.....634.00
 K.....606.00
 L.....578.00

"M. M." finish

No. 6577 1/4

Die.....5.0 x 1.0 x 4.0..20.0
 B. Ba. (S.S.)..6.6 x 1.10 x 1.0..11.11

Weight complete 5800 lbs.

D.....\$484.00
 F.....464.00
 G.....454.00
 H.....444.00
 I.....434.00
 K.....419.00
 L.....404.00

"M. M." finish

No. 6577 1/2

Die.....5.0 x 0.10 x 4.0..16.8
 B. Ba. (S.S.)..6.6 x 1.8 x 1.0..10.10

Weight complete 4900 lbs.

D.....\$436.00
 F.....420.00
 G.....411.00
 H.....403.00
 I.....395.00
 K.....382.00
 L.....370.00

"M. M." finish

No. 6577 3/4

Die.....5.0 x 0.8 x 4.0..13.4
 B. Ba. (S.S.)..6.6 x 1.6 x 1.0..9.9

Weight complete 4100 lbs.

D.....\$389.00
 F.....375.00
 G.....369.00
 H.....362.00
 I.....355.00
 K.....345.00
 L.....335.00

"M. M." finish

No. 6578

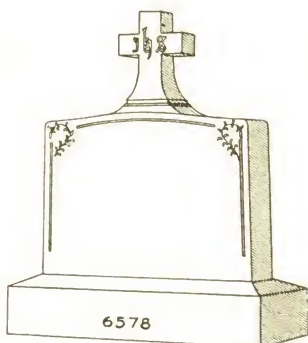

Cross.....1.4 x 0.6 x 2. 0.. 1.4
 Die.....4.0 x 1.2 x 2.10..13.3
 B.Ba. (S.S.) 5.0 x 2.0 x 1. 2..11.8
 Weight complete 4550 lbs.
 D.....\$284.00
 F.....270.00
 G.....262.00
 H.....255.00
 I.....248.00
 K.....237.00
 L.....226.00

"M. M." finish

No. 6578¹/₄

Cross.....1.3 x 0. 5 x 1.10..0.11
 Die.....3.6 x 1. 0 x 2. 8..9. 4
 B.Ba. (S.S.) 4.6 x 1.10 x 1. 0..8. 3
 Weight complete 3200 lbs.
 D.....\$214.00
 F.....204.00
 G.....199.00
 H.....194.00
 I.....189.00
 K.....181.00
 L.....173.00

"M. M." finish

No. 6578¹/₂

Cross.....1.2 x 0. 4 x 1.10..0.9
 Die.....3.6 x 0.10 x 2. 8..7.9
 B.Ba. (S.S.) 4.6 x 1. 8 x 1. 0..7.6
 Weight complete 2775 lbs.
 D...\$188.00 I..... 167.00
 F... 180.00 K..... 161.00
 G... 176.00 L..... 154.00
 H.... 171.00

"M. M." finish

No. 6578³/₄

Cross.....1.2 x 0.4 x 1.10..0.9
 Die.....3.6 x 0.8 x 2. 8..6.3
 B. Ba. (S.S.) 4.6 x 1.6 x 1. 0..6.9
 Weight complete 2400 lbs.
 D...\$164.00 I..... 147.00
 F... 158.00 K..... 142.00
 G... 154.00 L..... 137.00
 H.... 151.00

"M. M." finish

No. 6579

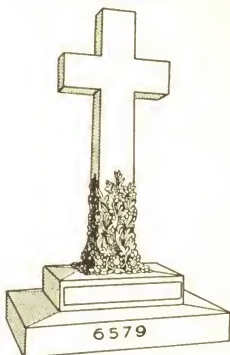

Cross.....3.6 x 1.2 x 8.10..36.1
 Neat.....8. 6
 Base.....3.8 x 2.9 x 1. 0..10.1
 B.Ba. (S.S.) 6.4 x 4.9 x 1. 0..30.1
 Weight complete 12000 lbs.

D.....\$1408.00
 F.....1362.00
 G.....1339.00
 H.....1316.00
 I.....1293.00
 K.....1258.00
 L.....1223.00

Pumice finished

No. 6579¹/₄

Cross.....2.8 x 1.0 x 6. 7..17.7
 Neat.....6. 4
 Base.....2.9 x 2.2 x 0.10.. 5.0
 B.Ba. (S.S.) 4.8 x 3.6 x 0.10..13.7
 Weight complete 5700 lbs.

D.....\$911.00
 F.....889.00
 G.....877.00
 H.....866.00
 I.....855.00
 K.....838.00
 L.....821.00

Pumice finished

No. 6580

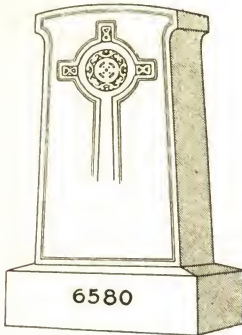

Die.....2.4 x 1.0 x 4.2 .9.9
 B. Ba. (S.S.) .3.4 x 1.10 x 1.0 .6.1
 Weight complete 2700 lbs.
 D.....\$210.00
 F.....200.00
 G.....195.00
 H.....190.00
 I.....186.00
 K.....178.00
 L.....171.00
 "M. M." finish

No. 6580¹/₄

Die.....2.4 x 0.10 x 4.2 .8.1
 B. Ba. (S.S.) .3.4 x 1.8 x 1.0 .5.7
 Weight complete 2350 lbs.
 D.....\$187.00
 F.....179.00
 G.....175.00
 H.....171.00
 I.....167.00
 K.....161.00
 L.....155.00
 "M. M." finish

No. 6580¹/₂

Die.....2.4 x 0.8 x 4.2 .6.6
 B. Ba. (S.S.) .3.2 x 1.4 x 1.0 .4.3
 Weight complete 1825 lbs.
 D.....\$159.00
 F.....153.00
 G.....150.00
 H.....146.00
 I.....143.00
 K.....138.00
 L.....133.00
 "M. M." finish

No. 6581

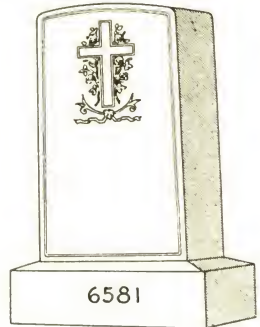

Die.....2.0 x 0.10 x 3.6 .5.10
 B. Ba. (S.S.) .2.10 x 1.6 x 1.0 .4.3
 Weight complete 1800 lbs.
 D.....\$134.00
 F.....128.00
 G.....125.00
 H.....122.00
 I.....119.00
 K.....115.00
 L.....111.00
 "M. M." finish

No. 6581¹/₄

Die.....2.0 x 0.8 x 3.6 .4.8
 B. Ba. (S.S.) .2.10 x 1.4 x 1.0 .3.9
 Weight complete 1500 lbs.
 D.....\$117.00
 F.....113.00
 G.....110.00
 H.....108.00
 I.....106.00
 K.....102.00
 L.....99.50
 "M. M." finish

No. 6581¹/₂

Die.....1.10 x 0.6 x 3.0 .2.9
 B. Ba. (S.S.) .2.6 x 1.0 x 0.10 .2.1
 Weight complete 870 lbs.
 D.....\$82.50
 F.....79.50
 G.....78.50
 H.....77.00
 I.....75.50
 K.....73.50
 L.....71.50
 "M. M." finish

No. 6582

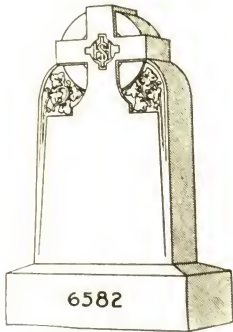

Die..... 2.4 x 1.0 x 4.4..10.1
 B. Ba. (S.S.) .3.4 x 1.10 x 1.0.. 6.1
 Weight complete 2900 lbs.

D.....	\$245.00
F.....	235.00
G.....	230.00
H.....	225.00
I.....	220.00
K.....	212.00
L.....	205.00

"M. M." finish

No. 6582¹/₄

Die..... 2.4 x 0.10 x 4.4..8.5
 B. Ba. (S.S.) .3.4 x 1.8 x 1.0..5.7
 Weight complete 2500 lbs.

D.....	\$219.00
F.....	211.00
G.....	207.00
H.....	202.00
I.....	198.00
K.....	192.00
L.....	186.00

"M. M." finish

No. 6582¹/₂

Die..... 2.4 x 0.8 x 4.4..6.9
 B. Ba. (S.S.) .3.2 x 1.4 x 1.0..4.3
 Weight complete 1900 lbs.

D.....	190.00
F.....	184.00
G.....	180.00
H.....	177.00
I.....	174.00
K.....	168.00
L.....	163.00

"M. M." finish

No. 6583

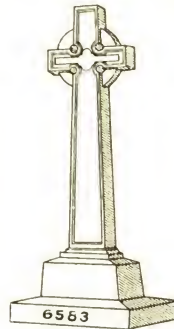

Cross..... 2.6 x 0.10 x 6.0..12.6
 Die..... 2.6 x 1.8 x 1.2.. 4.10
 B. Ba. (S.S.) .3.6 x 2.4 x 0.8.. 5.5
 Weight complete 2550 lbs.

D.....	\$314.00
F.....	296.00
G.....	288.00
H.....	279.00
I.....	270.00
K.....	257.00
L.....	244.00

"M. M." finish

No. 6583¹/₄

Cross..... 2.0 x 0.8 x 5.6..7.4
 Die..... 2.0 x 1.6 x 1.0..3.0
 B. Ba. (S.S.) .2.10 x 2.2 x 0.6..3.1
 Weight complete 1550 lbs.

D.....	\$199.00
F.....	189.00
G.....	184.00
H.....	179.00
I.....	173.00
K.....	166.00
L.....	158.00

"M. M." finish

No. 6583¹/₂

Cross..... 1.9 x 0.6 x 5.2..4.6
 Die..... 1.10 x 1.4 x 1.0..2.5
 B. Ba. (S.S.) .2.8 x 2.0 x 0.6..2.8
 Weight complete 1650 lbs.

D.....	\$153.00
F.....	147.00
G.....	143.00
H.....	140.00
I.....	136.00
K.....	131.00
L.....	126.00

"M. M." finish

No. 6584

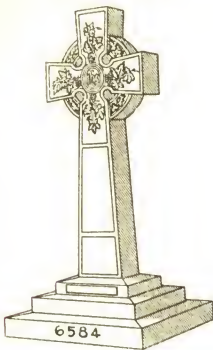

Cross.....3.5 x 1.0 x 8.11..30.6
 Base.....3.6 x 3.0 x 0.11.. 9.8
 B.Ba. (S.S.) .4.8 x 4.2 x 0. 8..13.0

Weight complete 7400 lbs.

D.....	\$880.00
F.....	840.00
G.....	820.00
H.....	800.00
I.....	780.00
K.....	750.00
L.....	719.00

"M. M." finish

No. 6585

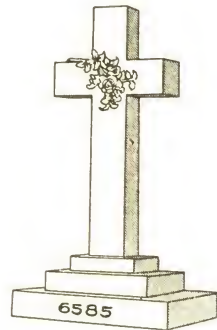

Cross.....3.0 x 1.0 x 6. 0..18.0
 Base.....3.0 x 2.2 x 1. 0.. 6.6
 B.Ba. (S.S.) .4.8 x 3.2 x 0.10..12.4

Weight complete 6600 lbs.

D.....	\$509.00
F.....	485.00
G.....	473.00
H.....	460.00
I.....	448.00
K.....	430.00
L.....	411.00

"M. M." finish

No. 6584¹/₄

Cross.....2.11 x 0.10x7. 6. 18. 3
 Base.....3. 0 x 2. 6x0.11.. 6.11
 B.Ba. (S.S.) .4. 0 x 3. 6x0. 8. 9. 4

Weight complete 4900 lbs.

D.....	\$623.00
F.....	597.00
G.....	585.00
H.....	572.00
I.....	560.00
K.....	541.00
L.....	522.00

"M. M." finish

No. 6585¹/₄

Cross.....2. 6 x 0.10x5. 0..10. 5
 Base.....2. 6x1.10x0.10.. 3.10
 B.Ba. (S.S.) .3.10x2. 8x0. 8.. 6.10

Weight complete 3750 lbs.

D.....	\$347.00
F.....	333.00
G.....	326.00
H.....	319.00
I.....	312.00
K.....	301.00
L.....	290.00

"M. M." finish

No. 6584¹/₂

Cross.....2.4 x 0. 8 x 6. 2..9.7
 Base.....2.6 x 2. 0 x 0.11..4.7
 B.Ba. (S.S.) .3.4 x 2.10 x 0. 8..6.4

Weight complete 3000 lbs.

D.....	\$417.00
F.....	403.00
G.....	396.00
H.....	389.00
I.....	382.00
K.....	371.00
L.....	360.00

"M. M." finish

No. 6585¹/₂

Cross.....2.0 x 0.8 x 4.0..5. 4
 Base.....2.0 x 1.5 x 0.8..1.11
 B. Ba. (S.S.) .3.2 x 2.2 x 0.6..3. 5

Weight complete 1900 lbs.

D.....	\$231.00
F.....	223.00
G.....	220.00
H.....	216.00
I.....	213.00
K.....	207.00
L.....	202.00

"M. M." finish

No. 6586



Cross.....1.4 x 0.6 x 1. 6..1.0
 Die.....1.4 x 1.0 x 0.10..1.1

Weight complete 375 lbs.

- D.....\$92.50
- F.....90.50
- G.....89.50
- H.....88.50
- I.....87.50
- K.....86.00
- L.....84.00

"M. M." finish

No. 6586¹/₄

Cross.....1.4 x 0.4 x 1. 6..0.8
 Die.....1.4 x 0.8 x 0.10..0.9

Weight complete 250 lbs.

- D.....\$82.00
- F.....81.00
- G.....80.00
- H.....79.50
- I.....78.50
- K.....77.50
- L.....76.50

"M. M." finish

No. 6587

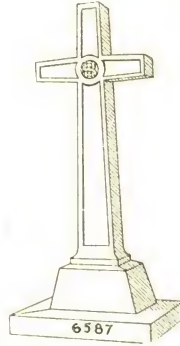

Cross.....3.2 x 1. 0 x 7.2..22.8
 Die.....2.6 x 1.10 x 1.3.. 5.9
 B.Ba. (S.S.) 3.4 x 2. 6 x 0.8.. 5.7

Weight complete 4200 lbs.

- C.....\$549.00
- D.....485.00
- F.....457.00
- G.....443.00
- H.....429.00
- I.....415.00
- K.....394.00
- L.....373.00

"M. M." finish

No. 6587¹/₄

Cross.....2.7 x 0.10 x 5.8..12.2
 Die.....2.0 x 1. 6 x 1.0.. 3.0
 B.Ba. (S.S.) 2.8 x 2. 0 x 0.6.. 2.8

Weight complete 2250 lbs.

- C.....\$352.00
- D.....318.00
- F.....303.00
- G.....295.00
- H.....287.00
- I.....279.00
- K.....268.00
- L.....257.00

"M. M." finish

No. 6587¹/₂

Cross.....2.0 x 0.8 x 4. 6..6.0
 Die.....1.6 x 1.2 x 0.10..1.6
 B. Ba. (S.S.) 2.0 x 1.7 x 0. 6..1.7

Weight complete 1300 lbs.

- C.....\$225.00
- D.....208.00
- F.....200.00
- G.....196.00
- H.....192.00
- I.....188.00
- K.....182.00
- L.....176.00

"M. M." finish

No. 6588

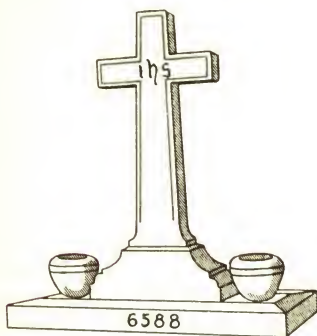

Cross.....4.0 x 1.0 x 7.6 .30.0
 Die.....4.0 x 1.2 x 1.8 . 7.9
 2 Vases.....1.8 x 1.8 x 1.6 . 8.4
 B. Ba. (S.S.) .9.0 x 2.6 x 1.0 .22.6

Weight complete 10200 lbs.

D.....\$795.00
 F..... 749.00
 G..... 726.00
 H..... 703.00
 I..... 680.00
 K..... 645.00
 L..... 610.00

"M. M." finish

No. 6588¹/₄

Cross.....3.4 x 0.10 x 6.2 .17.2
 Die.....3.4 x 1.0 x 1.6 . 5.0
 2 Vases.....1.5 x 1.5 x 1.3 . 5.0
 B. Ba. (S.S.) .7.10 x 2.0 x 0.10 .13.1

Weight complete 6000 lbs.

D.....\$519.00
 F..... 492.00
 G..... 468.00
 H..... 454.00
 I..... 440.00
 K..... 420.00
 L..... 400.00

"M. M." finish

No. 6588¹/₂

Cross.....2.8 x 0.8 x 5.0 .8.11
 Die.....2.8 x 0.10 x 1.2 . 2.7
 2 Vases.....1.2 x 1.2 x 1.0 . 2.8
 B. Ba. (S.S.) .6.4 x 1.8 x 0.8 . 7.0

Weight complete 3100 lbs.

D.....\$331.00
 F..... 317.00
 G..... 310.00
 H..... 303.00
 I..... 296.00
 K..... 285.00
 L..... 274.00

"M. M." finish

No. 6589



Cross.....2.2 x 0.10 x 3.10 .6.11
 B. Ba. (S.S.) .2.8 x 1.10 x 1.2 . 5.8

Weight complete 1875 lbs.

C.....\$261.00
 D..... 245.00
 F..... 238.00
 G..... 235.00
 H..... 232.00
 I..... 229.00
 K..... 224.00
 L..... 219.00

"M. M." finish

No. 6589¹/₄

Cross.....1.10 x 0.8 x 3.4 .4.1
 B. Ba. (S.S.) .2.4 x 1.6 x 1.0 .3.6

Weight complete 1100 lbs.

C.....\$187.00
 D..... 178.00
 F..... 174.00
 G..... 172.00
 H..... 170.00
 I..... 168.00
 K..... 165.00
 L..... 162.00

"M. M." finish

No. 6589¹/₂

Cross.....1.6 x 0.6 x 2.10 .2.2
 B. Ba. (S.S.) .2.0 x 1.4 x 1.0 .2.8

Weight complete 700 lbs.

C.....\$138.00
 D..... 133.00
 F..... 131.00
 G..... 130.00
 H..... 129.00
 I..... 128.00
 K..... 126.00
 L..... 124.00

"M. M." finish

No. 6590



Cross.....2.4 x 0.10 x 5. 2..10.1
 B.Ba. (S.S.) .3.2 x 1. 4 x 0.10.. 3.6
 Weight complete 2000 lbs.

- C.....\$403.00
- D..... 380.00
- F..... 370.00
- G..... 365.00
- H..... 360.00
- I..... 355.00
- K..... 347.00
- L..... 339.00

Hone finish

No. 6590¹/₄

Cross.....2. 0 x 0.8 x 4.6..6.0
 B. Ba. (S.S.) .2.10 x 1.2 x 0.8..2.2
 Weight complete 1200 lbs.

- C.....\$303.00
- D..... 289.00
- F..... 283.00
- G..... 280.00
- H..... 277.00
- I..... 274.00
- K..... 269.00
- L..... 264.00

Hone finish

No. 6590¹/₂

Cross.....2. 0 x 0.6 x 4.6..4. 6
 B.Ba. (S.S.) .2.10 x 1.0 x 0.8..1.11
 Weight complete 950 lbs.

- C.....\$272.00
- D..... 262.00
- F..... 257.00
- G..... 255.00
- H..... 253.00
- I..... 251.00
- K..... 248.00
- L..... 245.00

Hone finish

No. 7000



Cross.....3.6 x 1.0 x 10.0..35.0
 B.Ba. (S.S.) .4.6 x 3.0 x 2.0..27.0
 Weight complete 9000 lbs.

- D.....\$697.00
- F..... 662.00
- G..... 644.00
- H..... 626.00
- I..... 608.00
- K..... 582.00
- L..... 556.00

"M. M." finish
 Carved on face only

No. 7000¹/₄

Cross.....3.0 x 0.10 x 7.0..17.6
 B.Ba. (S.S.) .4.0 x 2. 0 x 1.6..12.0
 Weight complete 4100 lbs.

- D.....\$365.00
- F..... 347.00
- G..... 338.00
- H..... 329.00
- I..... 320.00
- K..... 307.00
- L..... 294.00

"M. M." finish
 Carved on face only

No. 7000¹/₂

Cross.....2.6 x 0. 8 x 5.0..8.4
 B. Ba. (S.S.) .3.6 x 1.10 x 1.4..8.7
 Weight complete 2500 lbs.

- D.....\$225.00
- F..... 217.00
- G..... 213.00
- H..... 209.00
- I..... 205.00
- K..... 199.00
- L..... 193.00

"M. M." finish
 Carved on face only

No. 7020

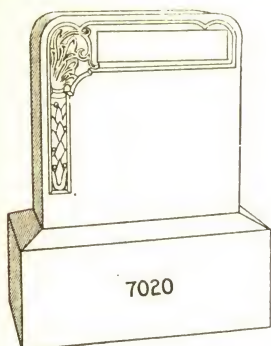

Die.....2.6 x 0.10 x 2.6 .5 3
 B. Base.....3.0 x 1.4 x 1.2 .4 8
 Weight complete 1725 lbs.; no B. B. 885 lbs.

- C.....\$104.00
- D.....92.00
- F.....87.00
- G.....84.50
- H.....81.50
- I.....79.00
- K.....75.00
- L.....71.00

If B. B. is omitted deduct \$16.35

No. 7020¹/₄

Die.....2.4 x 0.8 x 2.4 .3 8
 B. Base.....2.10 x 1.2 x 1.0 .3 4
 Weight complete 1225 lbs.; no B. B. 625 lbs.

- C.....\$78.50
- D.....70.50
- F.....66.50
- G.....65.00
- H.....63.00
- I.....61.00
- K.....58.50
- L.....55.50

If B. B. is omitted deduct \$11.65

No. 7020¹/₂

Die.....2.0 x 0.8 x 2.0 .2 8
 B. Base.....2.6 x 1.2 x 1.0 .2 11
 Weight complete 1175 lbs.; no B. B. 650 lbs.

- C.....\$64.00
- D.....58.00
- F.....55.00
- G.....54.00
- H.....52.50
- I.....51.00
- K.....49.00
- L.....47.00

If B. B. is omitted deduct \$10.50

No. 7021

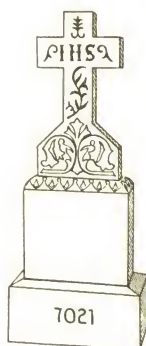

Cross.....1.2 x 0.4 x 2.4 .0 11
 Die.....1.6 x 0.8 x 1.8 .1 8
 B. Base.....1.10 x 1.0 x 0.10 .1 6
 Weight complete 650 lbs.; no B. B. 380 lbs.

- C.....\$61.00
- D.....55.50
- F.....52.50
- G.....51.50
- H.....50.00
- I.....48.75
- K.....47.00
- L.....45.00

If B. B. is omitted deduct \$5.40

No. 7021¹/₄

Cross.....1.0 x 0.4 x 2.0 .0 8
 Die.....1.4 x 0.8 x 1.6 .1 4
 B. Base.....1.8 x 1.0 x 0.10 .1 5
 Weight complete 550 lbs.; no B. B. 295 lbs.

- C.....\$52.50
- D.....48.00
- F.....46.00
- G.....45.00
- H.....44.00
- I.....43.00
- K.....41.50
- L.....40.00

If B. B. is omitted deduct \$5.10

No. 7025

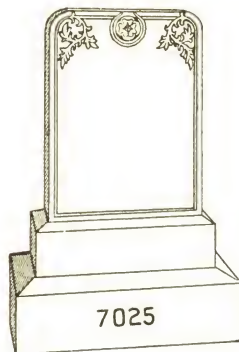

Die.....1.6 x 0.6 x 2. 0..1.6
 Base.....1.9 x 0.9 x 0. 5..0.7
 B. Base.....2.2 x 1.2 x 0.10..2.1
 Weight complete 750 lbs.; no B. B. 375 lbs.

- C.....\$47.00
- D.....42.25
- F.....40.25
- G.....39.25
- H.....38.00
- I.....37.00
- K.....35.50
- L.....34.00

If B. B. is omitted deduct \$7.50

No. 7026

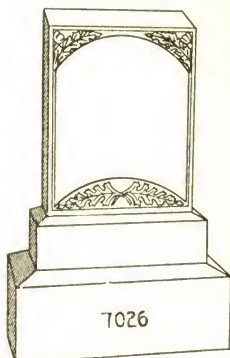

Die.....1.6 x 0.6 x 2. 0..1.6
 Base.....1.9 x 0.9 x 0. 5..0.7
 B. Base.....2.2 x 1.2 x 0.10..2.1
 Weight complete 725 lbs.; no B. B. 350 lbs.

- C.....\$45.75
- D.....41.00
- F.....39.00
- G.....38.00
- H.....36.75
- I.....35.75
- K.....34.25
- L.....32.75

If B. B. is omitted deduct \$7.50

No. 7025¹/₄

Die.....1.6 x 0.4 x 2. 0..1. 0
 Base.....1.9 x 0.7 x 0. 4..0. 4
 B. Base.....2.2 x 1.0 x 0.10..1.10
 Weight complete 570 lbs.; no B. B. 240 lbs.

- C.....\$35.50
- D.....32.50
- F.....31.00
- G.....30.50
- H.....29.75
- I.....29.00
- K.....28.00
- L.....27.00

If B. B. is omitted deduct \$6.60

No. 7026¹/₄

Die.....1.6 x 0.4 x 2. 0..1. 0
 Base.....1.9 x 0.7 x 0. 4..0. 4
 B. Base.....2.2 x 1.0 x 0.10..1.10
 Weight complete 550 lbs.; no B. B. 220 lbs.

- C.....\$34.25
- D.....31.25
- F.....29.75
- G.....29.25
- H.....28.50
- I.....27.75
- K.....26.75
- L.....25.75

If B. B. is omitted deduct \$6.60

No. 7028

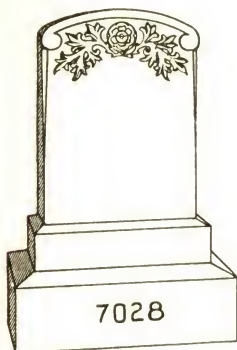

Die.....1.6 x 0.6 x 2. 0. .1.6
 Base.....1.9 x 0.9 x 0. 5. .0.7
 B. Base.....2.2 x 1.2 x 0.10. .2.1
 Weight complete 725 lbs.; no B. B. 350 lbs.

C.....\$47.00
 D.....42.25
 F.....40.25
 G.....39.25
 H.....38.00
 I.....37.00
 K.....35.50
 L.....34.00
 If B. B. is omitted deduct \$7.50

No. 7029

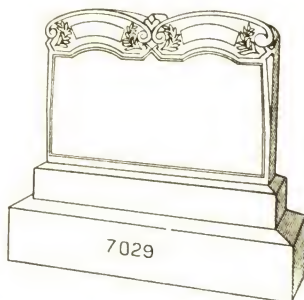

Die.....2. 8 x 0.6 x 1.10. .2.5
 Base.....2.11 x 0.9 x 0. 6. .1.1
 B. Base.....3. 4 x 1.2 x 0.10. .3.3
 Weight complete 1175 lbs.; no B. B. 590 lbs.

C.....\$72.00
 D.....64.00
 F.....60.50
 G.....59.00
 H.....57.50
 I.....55.50
 K.....53.00
 L.....50.50
 If B. B. is omitted deduct \$11.40

No. 7028¹/₄

Die.....1.6 x 0.4 x 2. 0. .1. 0
 Base.....1.9 x 0.7 x 0. 4. .0. 4
 B. Base.....2.2 x 1.0 x 0.10. .1. 10
 Weight complete 550 lbs.; no B. B. 220 lbs.

C.....\$35.50
 D.....32.50
 F.....31.00
 G.....30.50
 H.....29.75
 I.....29.00
 K.....28.00
 L.....27.00
 If B. B. is omitted deduct \$6.60

No. 7029¹/₄

Die.....2. 8 x 0.4 x 1.10. .1.8
 Base.....2.11 x 0.7 x 0. 5. .0.9
 B. Base.....3. 4 x 1.0 x 0.10. .2.9
 Weight complete 900 lbs.; no B. B. 405 lbs.

C.....\$55.00
 D.....49.50
 F.....47.00
 G.....45.75
 H.....44.75
 I.....43.50
 K.....41.50
 L.....39.75
 If B. B. is omitted deduct \$9.90

No. 7045

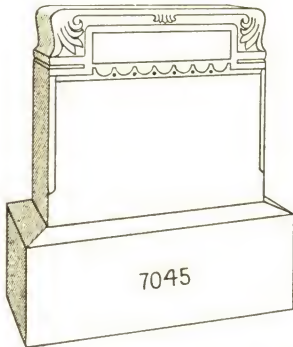

Die.....2.6 x 1.0 x 2.4 .5.10
 B. Base.....3.0 x 1.6 x 1.2 .5. 3
 Weight complete 1925 lbs.; no B. B. 980 lbs.
 C.....\$108.00
 D.....94.50
 F.....88.50
 G.....85.50
 H.....83.00
 I.....80.00
 K.....75.50
 L.....71.00
 If B. B. is omitted deduct \$18.40

No. 7052

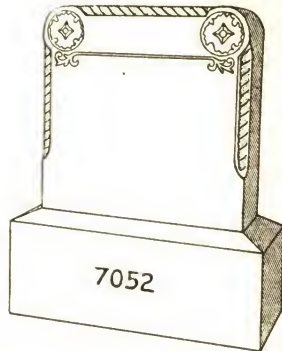

Die.....2.4 x 0.10 x 2.4 .4.6
 B. Base.....2.10 x 1.4 x 1.0 .3.9
 Weight complete 1450 lbs.; no B. B. 775 lbs.
 C.....\$89.00
 D.....79.00
 F.....74.50
 G.....72.00
 H.....70.00
 I.....67.50
 K.....64.00
 L.....61.00
 If B. B. is omitted deduct \$13.15

No. 7045¹/₄

Die.....2.4 x 0.10 x 2.2 .4.3
 B. Base.....2.10 x 1.4 x 1.0 .3.9
 Weight complete 1375 lbs.; no B. B. 700 lbs.
 C.....\$79.50
 D.....70.00
 F.....66.00
 G.....64.00
 H.....61.50
 I.....59.50
 K.....56.50
 L.....53.00
 If B. B. is omitted deduct \$13.15

No. 7045¹/₂

Die.....2.4 x 0.8 x 2.2 .3.4
 B. Base.....2.10 x 1.2 x 1.0 .3.4
 Weight complete 1150 lbs.; no B. B. 550 lbs.
 C.....\$68.00
 D.....60.50
 F.....57.50
 G.....55.50
 H.....54.00
 I.....52.50
 K.....49.75
 L.....47.25
 If B. B. is omitted deduct \$11.65

No. 7052¹/₄

Die.....2.0 x 0.8 x 2.0 .2.8
 B. Base.....2.6 x 1.2 x 1.0 .2.11
 Weight complete 1000 lbs.; no B. B. 475 lbs.
 C.....\$59.50
 D.....53.50
 F.....50.50
 G.....49.25
 H.....48.00
 I.....46.75
 K.....44.75
 L.....42.75
 If B. B. is omitted deduct \$10.50

No. 7055

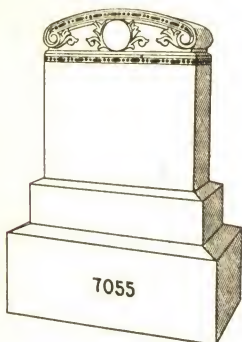

Die.....2. 6 x 1. 0 x 2.8. .6.8
 Base.....2.10 x 1. 4 x 0.8. .2.6
 B. Base....3. 4 x 1.10 x 1.2. .7.2
 Weight complete 2800 lbs.; no B.B.1510 lbs.
 G.....\$145.00
 H.....140.00
 I.....136.00
 K.....129.00
 L.....122.00
 If B. B. is omitted deduct \$25.10

No. 7055¹/₄

Die.....2.4 x 0.10 x 2.6. .4.10
 Base.....2.8 x 1. 2 x 0.8. .2. 1
 B. Base....3.2 x 1. 8 x 1.2. .6. 2
 Weight complete 2275 lbs.; no B.B.1165 lbs.
 G.....\$117.00
 H.....114.00
 I.....110.00
 K.....105.00
 L.....100.00
 If B. B. is omitted deduct \$21.60

No. 7055¹/₂

Die.....2.2 x 0.8 x 2.4. .3.4
 Base.....2.6 x 1.0 x 0.8. .1.8
 B. Base....3.0 x 1.6 x 1.0. .4.6
 Weight complete 1650 lbs.; no B. B. 840 lbs.
 G.....\$84.50
 H.....82.00
 I.....79.50
 K.....76.00
 L.....72.00
 If B. B. is omitted deduct \$15.75

No. 7055³/₄

Die.....1.6 x 0.6 x 2. 0. .1.6
 Base.....1.9 x 0.9 x 0. 5. .0.7
 B. Base....2.2 x 1.2 x 0.10. .2.1
 Weight complete 700 lbs.; no B. B. 325 lbs.
 G.....\$42.75
 H.....41.50
 I.....40.50
 K.....39.00
 L.....37.50
 If B. B. is omitted deduct \$7.50

No. 7077

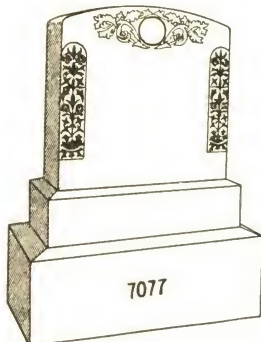

Die.....2. 6 x 1. 0 x 2.6. .6.3
 Base.....2.10 x 1. 4 x 0.8. .2.6
 B. Base....3. 4 x 1.10 x 1.2. .7.2
 Weight complete 2750 lbs.; no B.B.1460 lbs.
 C.....\$155.00
 D.....135.00
 F.....127.00
 G.....122.00
 H.....118.00
 I.....114.00
 K.....107.00
 L.....100.00
 If B. B. is omitted deduct \$25.10

No. 7077¹/₄

Die.....2.4 x 0.10 x 2.4. .4.6
 Base.....2.8 x 1. 2 x 0.8. .2.1
 B. Base....3.2 x 1. 8 x 1.0. .5.3
 Weight complete 2050 lbs.; no B.B.1105 lbs.
 C.....\$118.00
 D.....103.00
 F.....96.00
 G.....93.00
 H.....89.50
 I.....86.50
 K.....81.50
 L.....76.50
 If B. B. is omitted deduct \$18.40

No. 7077¹/₂

Die.....2.2 x 0.8 x 2.2. .3.2
 Base.....2.6 x 1.0 x 0.8. .1.8
 B. Base....3.0 x 1.6 x 1.0. .4.6
 Weight complete 1625 lbs.; no B. B. 815 lbs.
 C.....\$91.00
 D.....80.00
 F.....75.00
 G.....72.50
 H.....70.50
 I.....68.00
 K.....64.00
 L.....60.50
 If B. B. is omitted deduct \$15.75

No. 7083

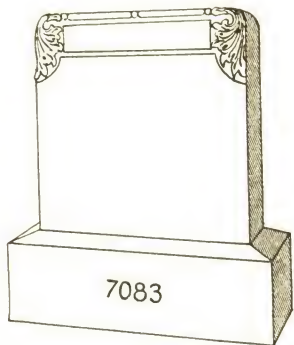

Die.....2.6 x 1.0 x 2.6 .6 3
 B. Base.....3.0 x 1.6 x 1.2 .5 3
 Weight complete 2050 lbs.; no B. B. 1105 lbs.

C.....	\$122.00
D.....	108.00
F.....	102.00
G.....	99.00
H.....	95.50
I.....	92.50
K.....	88.00
L.....	83.00

If B. B. is omitted deduct \$18.40

No. 7106

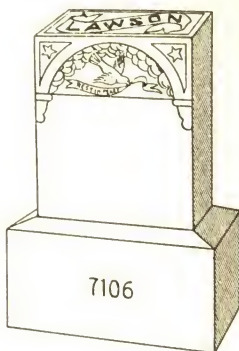

Die.....1.4 x 0.6 x 1.6 .1 0
 B. Base.....1.8 x 0.10 x 0.10 .1 2
 Weight complete 375 lbs.; on B. B. 165 lbs.

C.....	\$25.75
D.....	23.50
F.....	22.50
G.....	22.00
H.....	21.50
I.....	21.00
K.....	20.25
L.....	19.50

If B. B. is omitted deduct \$4.20

No. 7083¹/₄

Die.....2.4 x 0.10 x 2.4 .4 6
 B. Base.....2.10 x 1.4 x 1.0 .3 9
 Weight complete 1475 lbs.; no B. B. 800 lbs.

C.....	\$94.00
D.....	84.00
F.....	79.50
G.....	77.00
H.....	75.00
I.....	72.50
K.....	69.00
L.....	66.00

If B. B. is omitted deduct \$13.15

No. 7106¹/₄

Die.....1.4 x 0.4 x 1.6 .0 8
 B. Base.....1.8 x 0.8 x 0.8 .0 9
 Weight complete 250 lbs.; no B. B. 115 lbs.

C.....	\$18.25
D.....	16.75
F.....	16.25
G.....	15.75
H.....	15.50
I.....	15.25
K.....	14.75
L.....	14.25

If B. B. is omitted deduct \$2.80

No. 7083¹/₂

Die.....2.0 x 0.8 x 2.0 .2 8
 B. Base.....2.6 x 1.2 x 1.0 .2 11
 Weight complete 1000 lbs.; no B. B. 475 lbs.

C.....	\$65.50
D.....	59.50
F.....	56.50
G.....	55.50
H.....	54.00
I.....	52.50
K.....	50.50
L.....	48.75

If B. B. is omitted deduct \$10.50

No. 7106¹/₂

Die.....1.2 x 0.4 x 1.4 .0 6
 B. Base.....1.6 x 0.8 x 0.8 .0 8
 Weight complete 210 lbs.; no B. B. 90 lbs.

C.....	\$14.50
D.....	13.25
F.....	12.75
G.....	12.50
H.....	12.25
I.....	12.00
K.....	11.50
L.....	11.25

If B. B. is omitted deduct \$2.50

No. 7115

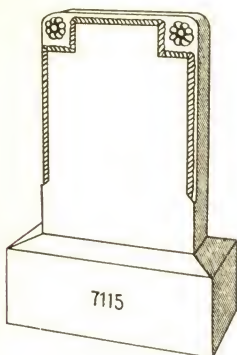

Die.....1.6 x 0.6 x 2. 0. .1.6
 B. Base.....2.0 x 1.0 x 0.10. .1.8
 Weight complete 550 lbs.; no B. B. 250 lbs.

- C.....\$37.25
- D.....33.75
- F.....32.25
- G.....31.50
- H.....30.75
- I.....30.00
- K.....28.75
- L.....27.75

If B. B. is omitted deduct \$6.00

No. 7120

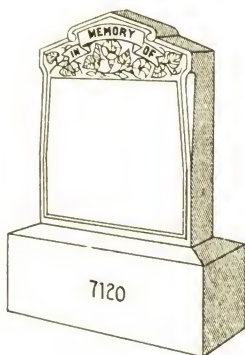

Die.....1.6 x 0.6 x 2. 0. .1.6
 B. Base.....2.0 x 1.0 x 0.10. .1.8
 Weight complete 540 lbs.; no B. B. 240 lbs.

- C.....\$34.75
- D.....31.25
- F.....29.75
- G.....29.00
- H.....28.25
- I.....27.50
- K.....26.25
- L.....25.25

If B. B. is omitted deduct \$6.00

No. 7115¹/₄

Die.....1.6 x 0.4 x 2. 0. .1.0
 B. Base.....2.0 x 0.10 x 0.10. .1.5
 Weight complete 425 lbs.; no B. B. 170 lbs.

- C.....\$30.00
- D.....27.75
- F.....26.75
- G.....26.25
- H.....25.75
- I.....25.25
- K.....24.50
- L.....23.75

If B. B. is omitted deduct \$5.10

No. 7120¹/₄

Die.....1.6 x 0.4 x 2. 0. .1.0
 B. Base.....2.0 x 0.10 x 0.10. .1.5
 Weight complete 425 lbs.; no B. B. 170 lbs.

- C.....\$25.75
- D.....23.50
- F.....22.50
- G.....22.00
- H.....21.50
- I.....21.00
- K.....20.25
- L.....19.50

If B. B. is omitted deduct \$5.10

No. 7125

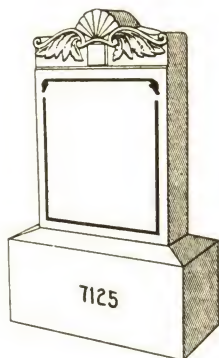

Die.....1.6 x 0.6 x 2. 0..1.6
 B. Base.....2.0 x 1.0 x 0.10..1.8
 Weight complete 540 lbs.; no B. B. 240 lbs.

C.....	\$37.25
D.....	33.75
F.....	32.25
G.....	31.50
H.....	30.75
I.....	30.00
K.....	28.75
L.....	27.75

If B. B. is omitted deduct \$6.00

No. 7135

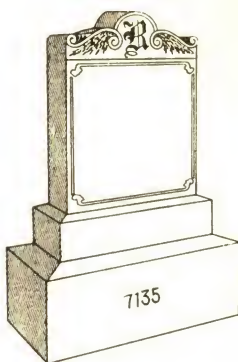

Die.....1.6 x 0.6 x 2. 0..1.6
 Base.....1.9 x 0.9 x 0. 5..0.7
 B. Base.....2.2 x 1.2 x 0.10..2.1
 Weight complete 700 lbs.; no B. B. 325 lbs.

C.....	\$45.75
D.....	41.00
F.....	39.00
G.....	38.00
H.....	36.75
I.....	35.75
K.....	34.25
L.....	32.75

If B. B. is omitted deduct \$7.50

No. 7125¹/₄

Die.....1.6 x 0. 4 x 2. 0..1.0
 B. Base.....2.0 x 0.10 x 0.10..1.5
 Weight complete 425 lbs.; no B. B. 170 lbs.

C.....	\$30.00
D.....	27.75
F.....	26.75
G.....	26.25
H.....	25.75
I.....	25.25
K.....	24.50
L.....	23.75

If B. B. is omitted deduct \$5.10

No. 7135¹/₄

Die.....1.6 x 0.4 x 2. 0..1. 0
 Base.....1.9 x 0.7 x 0. 4..0. 4
 B. Base.....2.2 x 1.0 x 0.10..1.10
 Weight complete 550 lbs.; no B. B. 220 lbs.

C.....	\$34.50
D.....	31.50
F.....	30.00
G.....	29.50
H.....	28.75
I.....	28.00
K.....	27.00
L.....	26.00

If B. B. is omitted deduct \$6.60

No. 7136



Die.....2.2 x 0.10 x 2.6...4.6
 B. Base.....2.8 x 1.4 x 1.0...3.7
 Weight complete 1350 lbs.; no B. B. 700 lbs.

C.....	\$92.00
D.....	82.00
F.....	77.50
G.....	75.00
H.....	73.00
I.....	70.00
K.....	67.00
L.....	64.00

If B. B. is omitted deduct \$12.55

No. 7137

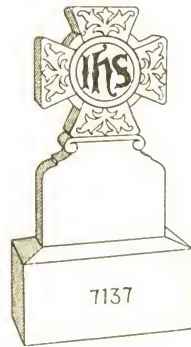

Cross.....1.6 x 0.4 x 2.10...1.5
 B. Base.....2.0 x 0.10 x 0.10...1.5
 Weight complete 425 lbs.; no B. B. 170 lbs.

C.....	\$41.00
D.....	37.75
F.....	36.25
G.....	35.50
H.....	34.75
I.....	34.25
K.....	33.00
L.....	32.00

If B. B. is omitted deduct \$5.10
 If back sand finished deduct \$1.50

No. 7137¹/₄

Cross.....1.4 x 0.4 x 2.6...1.1
 B. Base.....1.9 x 0.9 x 0.10...1.1
 Weight complete 340 lbs.; no B. B. 145 lbs.

C.....	\$35.00
D.....	32.50
F.....	31.50
G.....	31.00
H.....	30.25
I.....	29.75
K.....	29.00
L.....	28.25

If B. B. is omitted deduct \$3.90
 If back sand finished deduct \$1.25

No. 7136¹/₄

Die.....2.2 x 0.8 x 2.6...3.7
 B. Base.....2.8 x 1.2 x 1.0...3.1
 Weight complete 1125 lbs.; no B. B. 570 lbs.

C.....	\$75.00
D.....	67.00
F.....	63.00
G.....	61.50
H.....	59.50
I.....	58.00
K.....	55.00
L.....	52.50

If B. B. is omitted deduct \$10.80

No. 7137¹/₂

Cross.....1.2 x 0.4 x 2.2...0.10
 B. Base.....1.7 x 0.9 x 0.10...1.0
 Weight complete 300 lbs.; no B. B. 120 lbs.

C.....	\$28.75
D.....	27.00
F.....	26.00
G.....	25.75
H.....	25.25
I.....	24.75
K.....	24.25
L.....	23.50

If B. B. is omitted deduct \$3.75
 If back sand finished deduct \$1.00

No. 7143

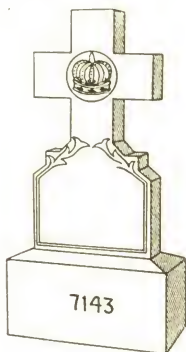

Cross.....1.6 x 0.4 x 2.10..1.5
 B. Base.....2.0 x 0.10 x 0.10..1.5
 Weight complete 425 lbs.; no B. B. 170 lbs.

C.....	\$40.25
D.....	37.00
F.....	35.50
G.....	34.75
H.....	34.00
I.....	33.50
K.....	32.25
L.....	31.25

If B. B. is omitted deduct \$5.10
 If back sand finished deduct \$1.50

No. 7143¹/₄

Cross.....1.4 x 0.4 x 2.6..1.1
 B. Base.....1.9 x 0.9 x 0.10..1.1
 Weight complete 350 lbs.; no B. B. 155 lbs.

C.....	\$34.00
D.....	31.50
F.....	30.50
G.....	30.00
H.....	29.25
I.....	28.75
K.....	28.00
L.....	27.25

If B. B. is omitted deduct \$3.90
 If back sand finished deduct \$1.25

No. 7143¹/₂

Cross.....1.2 x 0.4 x 2.2..0.10
 B. Base.....1.7 x 0.9 x 0.10..1.0
 Weight complete 300 lbs.; no B. B. 120 lbs.

C.....	\$27.75
D.....	26.00
F.....	25.00
G.....	24.75
H.....	24.25
I.....	23.75
K.....	23.25
L.....	22.50

If B. B. is omitted deduct \$3.75
 If back sand finished deduct \$1.00

No. 7154

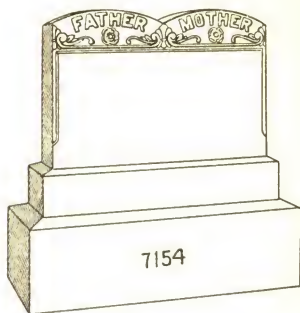

Die.....2.8 x 0.6 x 1.10..2.5
 Base.....2.11 x 0.9 x 0.6..1.1
 B. Base.....3.4 x 1.2 x 0.10..3.3
 Weight complete 1050 lbs.; no B. B. 465 lbs.

C.....	\$79.00
D.....	71.00
F.....	68.00
G.....	66.00
H.....	64.50
I.....	62.50
K.....	60.00
L.....	57.50

If B. B. is omitted deduct \$11.40
 Price does not include lettering

No. 7154¹/₄

Die.....2.8 x 0.4 x 1.10..1.8
 Base.....2.11 x 0.7 x 0.5..0.9
 B. Base.....3.4 x 1.0 x 0.10..2.9
 Weight complete 925 lbs.; no B. B. 430 lbs.

C.....	\$64.50
D.....	59.00
F.....	57.00
G.....	55.50
H.....	54.50
I.....	53.00
K.....	51.50
L.....	49.50

If B. B. is omitted deduct \$9.90
 Price does not include lettering

No. 7155

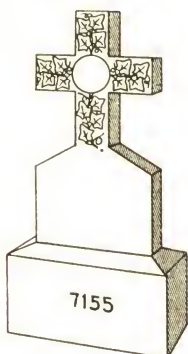

Cross.....1.6 x 0. 4 x 2.10..1.5
 B. Base.....2.0 x 0.10 x 0.10..1.5
 Weight complete 425 lbs.; no B. B. 170 lbs.

- C.....\$39.25
- D.....36.00
- F.....34.50
- G.....33.75
- H.....33.00
- I.....32.50
- K.....31.25
- L.....30.25

If B. B. is omitted deduct \$5.10
 If back sand finished deduct \$1.50

No. 7155¹/₄

Cross.....1.4 x 0.4 x 2. 6..1.1
 B. Base.....1.9 x 0.9 x 0.10..1.1
 Weight complete 350 lbs.; no B. B. 155 lbs.

- C.....\$33.00
- D.....30.50
- F.....29.50
- G.....29.00
- H.....28.25
- I.....27.75
- K.....27.00
- L.....26.25

If B. B. is omitted deduct \$3.90
 If back sand finished deduct \$1.25

No. 7155¹/₂

Cross.....1.2 x 0.4 x 2. 2..0.10
 B. Base.....1.7 x 0.9 x 0.10..1. 0
 Weight complete 300 lbs.; no B. B. 120 lbs.

- C.....\$26.75
- D.....25.00
- F.....24.00
- G.....23.75
- H.....23.25
- I.....22.75
- K.....22.25
- L.....21.50

If B. B. is omitted deduct \$3.75
 If back sand finished deduct \$1.00

No. 7183

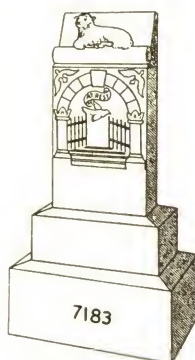

Die.....1.4 x 0.10 x 3.0..3.4
 Base.....1.8 x 1. 2 x 0.8..1.4
 B. Base.....2.0 x 1. 6 x 1.0..3.0
 Weight complete 1300 lbs.; no B. B. 760 lbs.

- C.....\$94.50
- D.....84.00
- F.....79.00
- G.....77.00
- H.....74.50
- I.....72.00
- K.....68.50
- L.....65.00

If B. B. is omitted deduct \$10.80

No. 7183¹/₄

Die.....1. 2 x 0.8 x 2. 8..2.1
 Base.....1. 6 x 1.0 x 0. 8..1.0
 B. Base.....1.10 x 1.4 x 0.10..2.0
 Weight complete 850 lbs.; no B. B. 490 lbs.

- C.....\$67.50
- D.....60.50
- F.....57.50
- G.....56.00
- H.....54.50
- I.....53.00
- K.....50.50
- L.....48.25

If B. B. is omitted deduct \$7.20

No. 7183¹/₂

Die.....1.0 x 0. 6 x 2. 6..1.3
 Base.....1.4 x 0.10 x 0. 6..0.7
 B. Base.....1.8 x 1. 2 x 0.10..1.7
 Weight complete 600 lbs.; no B. B. 315 lbs.

- C.....\$46.00
- D.....42.25
- F.....40.25
- G.....39.50
- H.....38.50
- I.....37.50
- K.....36.25
- L.....34.75

If B. B. is omitted deduct \$5.70

No. 7184



Cross.....2.6 x 1.0 x 3.6 . . 8. 9
 Die.....2.6 x 1.4 x 1.2 . . 3.11
 B. Base.....3.2 x 2.0 x 1.0 . . 6. 4
 Weight complete 2500 lbs.; no B.B.1360 lbs.

C.....\$350.00
 D.....321.00
 F.....309.00
 G.....302.00
 H.....296.00
 I.....290.00
 K.....280.00
 L.....271.00

If B. B. is omitted deduct \$22.15
 Prices do not include lettering

No. 7202

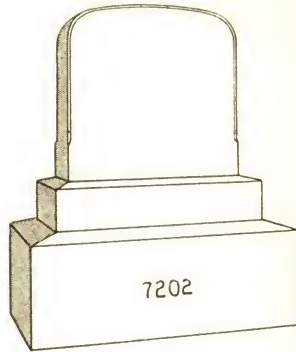

Die.....1.8 x 0.8 x 1.8 . . 1.10
 Base.....2.0 x 1.0 x 0.5 . . 0.10
 B. Base.....2.6 x 1.6 x 1.0 . . 3. 9
 Weight complete 950 lbs.; no B. B. 275 lbs.

C.....\$59.50
 D.....53.50
 F.....50.50
 G.....49.25
 H.....48.00
 I.....46.75
 K.....44.75
 L.....42.75

If B. B. is omitted deduct \$13.15

No. 7202¹/₄

Die.....1.6 x 0.6 x 1. 6 . . 1.2
 Base.....1.9 x 0.9 x 0. 5 . . 0.7
 B. Base.....2.2 x 1.2 x 0.10 . . 2.1
 Weight complete 675 lbs.; no B. B. 300 lbs.

C.....\$38.75
 D.....35.00
 F.....33.25
 G.....32.25
 H.....31.25
 I.....30.50
 K.....29.25
 L.....27.75

If B. B. is omitted deduct \$7.50

No. 7184¹/₄

Cross.....2.2 x 0.9 x 2. 8 . . 4. 4
 Die.....2.0 x 1.0 x 0.11 . . 1.10
 B. Base.....2.6 x 1.6 x 0. 8 . . 2. 6
 Weight complete 1000 lbs.; no B. B. 550 lbs.

C.....\$207.00
 D.....193.00
 F.....187.00
 G.....184.00
 H.....181.00
 I.....178.00
 K.....173.00
 L.....168.00

If B. B. is omitted deduct \$9.00
 Prices do not include lettering

No. 7202¹/₂

Die.....1.4 x 0.4 x 1. 4 . . 0.7
 Base.....1.7 x 0.7 x 0. 4 . . 0.4
 B. Base.....2.0 x 1.0 x 0.10 . . 1.8
 Weight complete 475 lbs.; no B. B. 175 lbs.

C.....\$25.00
 D.....23.00
 F.....22.00
 G.....21.50
 H.....21.00
 I.....20.75
 K.....20.00
 L.....19.25

If B. B. is omitted deduct \$6.00

No. 7208

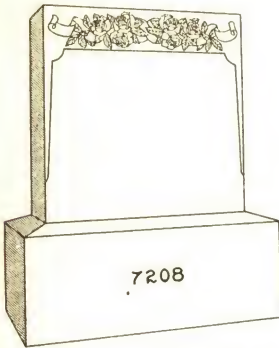

Die.....2.6 x 1.0 x 2.6..6. 3
 B. Base.....3.0 x 1.6 x 1.2..5. 3
 Weight complete 2050 lbs.; no B.B. 1100 lbs.

- C.....\$117.00
- D.....103.00
- F.....97.00
- G.....94.00
- H.....90.50
- I.....87.50
- K.....83.00
- L.....78.00

If B. B. is omitted deduct \$18.40

No. 7208¹/₄

Die.....2.4 x 0.10 x 2.4..4.6
 B. Base.....2.10 x 1.4 x 1.0..3.9
 Weight complete 1500 lbs.; no B. B. 825 lbs.

- C.....\$84.00
- D.....74.00
- F.....69.50
- G.....67.00
- H.....65.00
- I.....62.50
- K.....59.00
- L.....56.00

If B. B. is omitted deduct \$13.15

No. 7208¹/₂

Die.....2.0 x 0.8 x 2.0..2. 8
 B. Base.....2.6 x 1.2 x 1.0..2. 11
 Weight complete 1000 lbs.; no B. B. 475 lbs.

- C.....\$55.50
- D.....49.50
- F.....47.00
- G.....45.50
- H.....44.25
- I.....43.00
- K.....41.00
- L.....39.00

If B. B. is omitted deduct \$10.50

No. 7209

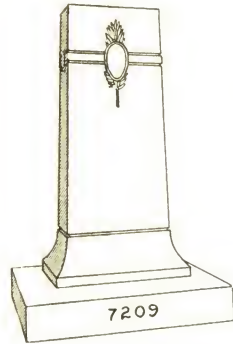

Die.....2.4 x 1.2 x 5.0..13.7
 Base.....3.0 x 1.10 x 1.0..5.6
 B. Base...4.4 x 3.2 x 0.10..11.5
 Weight complete 5000 lbs.; no B.B. 2945 lbs.

- C.....\$398.00
- D.....356.00
- F.....336.00
- G.....327.00
- H.....317.00
- I.....308.00
- K.....294.00
- L.....279.00

If B. B. is omitted deduct \$39.95

No. 7209¹/₄

Die.....2.4 x 1.0 x 5.0..11. 8
 Base.....3.0 x 1.8 x 1.0..5. 0
 B. Base...4.4 x 3.0 x 0.10..10. 10
 Weight complete 2900 lbs.; no B. B. 950 lbs.

- C.....\$356.00
- D.....318.00
- F.....302.00
- G.....293.00
- H.....285.00
- I.....277.00
- K.....264.00
- L.....252.00

If B. B. is omitted deduct \$37.90

No. 7210

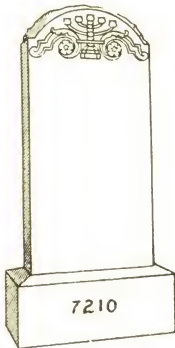

Die.....1.10 x 0.8 x 3.8. .4.6
 B. Base.....2. 4 x 1.2 x 1.2. .3.2
 Weight complete 1350 lbs.; no B. B. 780 lbs.

C.....	\$76.00
D.....	66.00
F.....	61.50
G.....	59.00
H.....	57.00
I.....	54.50
K.....	51.00
L.....	47.75

If B. B. is omitted deduct \$11.10
 Face only polished; balance sand finished

No. 7211

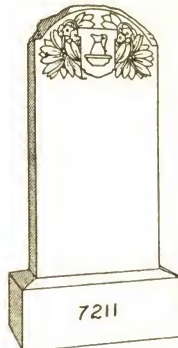

Die.....1.10 x 0.8 x 3.8. .4.6
 B. Base.....2. 4 x 1.2 x 1.2. .3.2
 Weight complete 1350 lbs.; no B. B. 780 lbs.

C.....	\$76.00
D.....	66.00
F.....	61.50
G.....	59.00
H.....	57.00
I.....	54.50
K.....	51.00
L.....	47.75

If B. B. is omitted deduct \$11.10
 Face only polished; balance sand finished

No. 7210¹/₄

Die.....1.8 x 0.6 x 3.6. .2.11
 B. Base.....2.2 x 1.0 x 1.0. .2. 2
 Weight complete 900 lbs.; no B. B. 510 lbs.

C.....	\$50.50
D.....	43.75
F.....	40.75
G.....	39.25
H.....	37.75
I.....	36.50
K.....	34.25
L.....	32.00

If B. B. is omitted deduct \$7.80
 Face only polished; balance sand finished

No. 7211¹/₄

Die.....1.8 x 0.6 x 3.6. .2.11
 B. Base.....2.2 x 1.0 x 1.0. .2. 2
 Weight complete 900 lbs.; no B. B. 510 lbs.

C.....	\$50.50
D.....	43.75
F.....	40.75
G.....	39.25
H.....	37.75
I.....	36.50
K.....	34.25
L.....	32.00

If B. B. is omitted deduct \$7.80
 Face only polished; balance sand finished

No. 7210¹/₂

Die.....1.6 x 0. 4 x 3. 4. .1.8
 B. Base.....2.0 x 0.10 x 0.10. .1.5
 Weight complete 550 lbs.; no B. B. 295 lbs.

C.....	\$31.00
D.....	27.25
F.....	25.75
G.....	24.75
H.....	24.00
I.....	23.25
K.....	22.00
L.....	20.75

If B. B. is omitted deduct \$5.10
 Face only polished; balance sand finished

No. 7211¹/₂

Die.....1.6 x 0. 4 x 3. 4. .1.8
 B. Base.....2.0 x 0.10 x 0.10. .1.5
 Weight complete 550 lbs.; no B. B. 295 lbs.

C.....	\$31.00
D.....	27.25
F.....	25.75
G.....	24.75
H.....	24.00
I.....	23.25
K.....	22.00
L.....	20.75

If B. B. is omitted deduct \$5.10
 Face only polished; balance sand finished

No. 7212

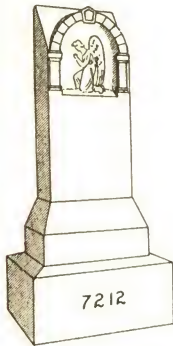

Die.....1. 6 x 0.10 x 3. 6..4. 5
 Base.....1.11 x 1. 3 x 0.10..2. 0
 B. Base...2. 5 x 1. 9 x 1. 2..4.11
 Weight complete 1975 lbs.; no B. B.1090 lbs.

- C.....\$143.00
- D.....128.00
- F.....122.00
- G.....119.00
- H.....115.00
- I.....112.00
- K.....107.00
- L.....103.00

If B. B. is omitted deduct \$17.20

No. 7212¹/₄

Die.....1.4 x 0.10 x 3. 0..3. 4
 Base.....1.9 x 1. 3 x 0.10..1.10
 B. Base...2.3 x 1. 9 x 1. 0..3.11
 Weight complete 1600 lbs.; no B. B. 895 lbs.

- C.....\$118.00
- D.....107.00
- F.....101.00
- G.....99.00
- H.....96.50
- I.....93.50
- K.....90.00
- L.....86.00

If B. B. is omitted deduct \$13.70

No. 7212¹/₂

Die.....1.2 x 0.8 x 2.10..2.2
 Base.....1.6 x 1.0 x 0. 8..1.0
 B. Base...2.0 x 1.6 x 1. 0..3.0
 Weight complete 1080 lbs.; no B. B. 540 lbs.

- C.....\$85.50
- D.....78.50
- F.....75.50
- G.....74.00
- H.....72.50
- I.....70.00
- K.....68.50
- L.....66.00

If B. B. is omitted deduct \$10.80

No. 7216

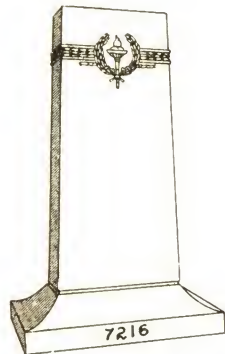

Die.....2.4 x 1.2 x 5. 0..13.7
 B.Ba. (S.S.) 3.8 x 2.2 x 0.10.. 6.7

Weight complete 3200 lbs.

- D.....\$358.00
- G.....337.00
- H.....331.00
- I.....324.00
- K.....314.00
- L.....303.00

"M. M." finish

No. 7216¹/₄

Die.....2.4 x 1.0 x 5. 0..11.8
 B.Ba. (S.S.) 3.8 x 2.0 x 0.10.. 6.1

Weight complete 2900 lbs.

- D.....\$327.00
- G.....309.00
- H.....304.00
- I.....298.00
- K.....289.00
- L.....280.00

"M. M." finish

No. 7217—A

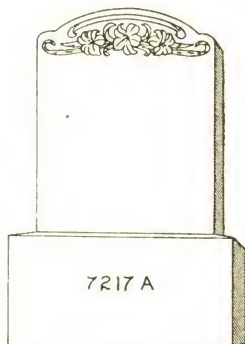

Die.....1. 6 x 0. 6 x 1. 10. .1.5
 B. Base....1. 10 x 0. 10 x 0. 10. .1.3
 Weight complete 475 lbs.; no B. B. 250 lbs.

- C.....\$30.25
- D.....27.00
- F.....25.50
- G.....24.75
- H.....24.00
- I.....23.50
- K.....22.25
- L.....21.25

If B. B. is omitted deduct \$4.50

No. 7217¹/₄—A

Die.....1.4 x 0. 6 x 1. 8. .1.1
 B. Base....1. 8 x 0. 10 x 0. 10. .1.2
 Weight complete 400 lbs.; no B. B. 190 lbs.

- C.....\$24.75
- D.....22.25
- F.....21.25
- G.....20.75
- H.....20.00
- I.....19.50
- K.....18.75
- L.....18.00

If B. B. is omitted deduct \$4.20

No. 7217¹/₂—A

Die.....1.4 x 0.4 x 1.8. .0.9
 B. Base....1. 8 x 0.8 x 0.8. .0.9
 Weight complete 270 lbs.; no B. B. 135 lbs.

- C.....\$18.25
- D.....16.75
- F.....15.75
- G.....15.50
- H.....15.00
- I.....14.75
- K.....14.25
- L.....13.50

If B. B. is omitted deduct \$2.80

No. 7217—B

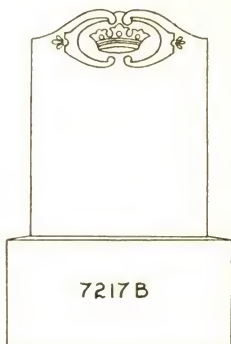

Sizes and prices same as 7217-A.

No. 7217—C

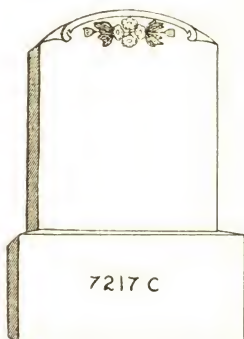

Sizes and prices same as 7217-A.

No. 7217—D

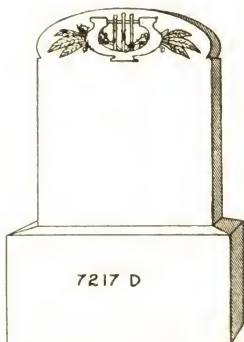

Sizes and prices same as 7217-A.

No. 7217—E



Sizes and prices same as 7217-A.

No. 7217—F

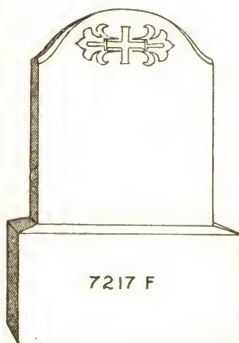

Sizes and prices same as 7217-A.

No. 7219³/₄

Die..... 1.8 x 0.6 x 2. 2. 1.10
 B. Base.... 2.2 x 1.0 x 0.10. 1.10
 Weight complete 650 lbs.; no B. B. 320 lbs.

- D.....\$41.00
- F..... 39.00
- G..... 38.25
- H..... 37.25
- I..... 36.25
- K..... 35.00
- L..... 33.50

If B. B. is omitted deduct \$6.60
 All polished

No. 7218

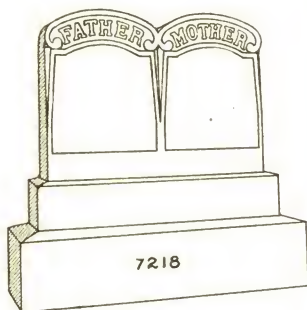

Die.....2. 8 x 0.6 x 1.10. .2.5
 Base.....2.11 x 0.9 x 0. 6. 1.1
 B. Base....3. 4 x 1.2 x 0.10. .3.3
 Weight complete 1200 lbs.; no B. B. 615 lbs.

- C.....\$75.50
- D..... 67.50
- F..... 64.50
- G..... 62.50
- H..... 61.00
- I..... 59.00
- K..... 56.50
- L..... 54.00

If B. B. is omitted deduct \$11.40
 If raised bands omitted deduct \$2.50

No. 7218¹/₄

Die.....2. 8 x 0.4 x 1.10. .1.8
 Base.....2.11 x 0.7 x 0. 5. .0.9
 B. Base....3. 4 x 1.0 x 0.10. .2.9
 Weight complete 925 lbs.; no B. B. 430 lbs.

- C.....\$58.50
- D..... 53.00
- F..... 51.00
- G..... 49.50
- H..... 48.25
- I..... 47.25
- K..... 45.25
- L..... 43.50

If B. B. is omitted deduct \$9.90
 If raised bands omitted deduct \$2.50

No. 7219

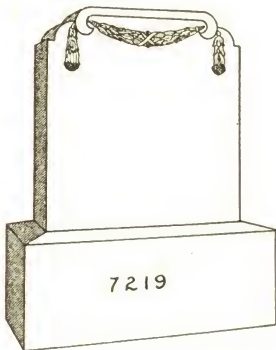

Die.....2.6 x 1.0 x 2.8 .6.8
 B. Base.....3.0 x 1.6 x 1.2 .5.3
 Weight complete 2000 lbs.; no B. B. 1055 lbs.

- D.....\$114.00
- F.....108.00
- G.....104.00
- H.....101.00
- I.....97.50
- K.....92.50
- L.....87.50

If B. B. is omitted deduct \$18.40
 All polished

No. 7219¹/₄

Die.....2.4 x 0.10 x 2.6 .4.10
 B. Base....2.10 x 1.4 x 1.0 .3.9
 Weight complete 1500 lbs.; no B. B. 825 lbs.

- D.....\$85.00
- F.....80.00
- G.....77.50
- H.....75.50
- I.....73.00
- K.....69.50
- L.....65.50

If B. B. is omitted deduct \$13.15
 All polished

No. 7219¹/₂

Die.....2.0 x 0.8 x 2.2 .2.11
 B. Base....2.6 x 1.2 x 1.0 .2.11
 Weight complete 1025 lbs.; no B. B. 500 lbs.

- D.....\$59.00
- F.....56.00
- G.....54.50
- H.....53.00
- I.....51.50
- K.....49.50
- L.....47.25

If B. B. is omitted deduct \$10.50
 All polished

No. 7219³/₄

See previous page

No. 7220

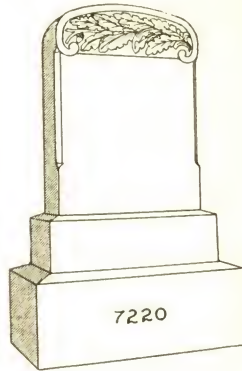

Die.....1.6 x 0.6 x 2.0 .1.6
 Base.....1.9 x 0.9 x 0.5 .0.7
 B. Base....2.2 x 1.2 x 0.10 .2.1
 Weight complete 700 lbs.; no B. B. 325 lbs.

- C.....\$50.50
- D.....45.75
- F.....43.75
- G.....42.75
- H.....41.50
- I.....40.50
- K.....39.00
- L.....37.50

If B. B. is omitted deduct \$7.50

No. 7220¹/₄

Die.....1.6 x 0.4 x 2.0 .1.0
 Base.....1.9 x 0.7 x 0.4 .0.4
 B. Base....2.2 x 1.0 x 0.10 .1.10
 Weight complete 525 lbs.; no B. B. 195 lbs.

- C.....\$38.00
- D.....35.00
- F.....33.50
- G.....33.00
- H.....32.25
- I.....31.50
- K.....30.50
- L.....29.50

If B. B. is omitted deduct \$6.60

No. 7221

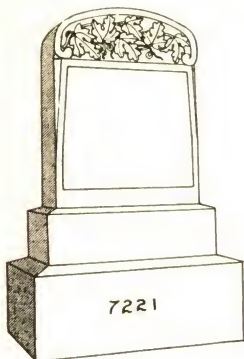

Die.....1.6 x 0.6 x 2. 0..1.6
 Base.....1.9 x 0.9 x 0. 5..0.7
 B. Base.....2.2 x 1.2 x 0.10..2.1
 Weight complete 700 lbs.; no B. B. 325 lbs.

- C.....\$51.50
- D.....46.75
- F.....44.75
- G.....43.75
- H.....42.50
- I.....41.50
- K.....40.00
- L.....38.50

If B. B. is omitted deduct \$7.50

No. 7222

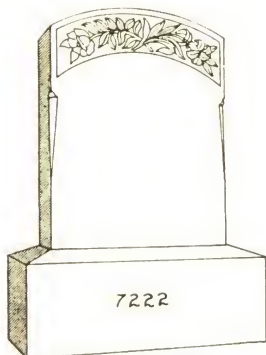

Die.....1.6 x 0.6 x 2. 0..1.6
 B. Base.....2.0 x 1.0 x 0.10..1.8
 Weight complete 550 lbs.; no B. B. 250 lbs.

- C.....\$36.75
- D.....33.25
- F.....31.75
- G.....31.00
- H.....30.25
- I.....29.50
- K.....28.25
- L.....27.25

If B. B. is omitted deduct \$6.00

No. 7221¹/₄

Die.....1.6 x 0.4 x 2. 0..1. 0
 Base.....1.9 x 0.7 x 0. 4..0. 4
 B. Base.....2.2 x 1.0 x 0.10..1.10
 Weight complete 525 lbs.; no B. B. 195 lbs.

- C.....\$40.50
- D.....37.50
- F.....36.00
- G.....35.50
- H.....34.75
- I.....34.00
- K.....33.00
- L.....32.00

If B. B. is omitted deduct \$6.60

No. 7222¹/₄

Die.....1.6 x 0. 4 x 2. 0..1.0
 B. Base.....2.0 x 0.10 x 0.10..1.5
 Weight complete 425 lbs.; no B. B. 170 lbs.

- C.....\$28.75
- D.....26.50
- F.....25.50
- G.....25.00
- H.....24.50
- I.....24.00
- K.....23.25
- L.....22.50

If B. B. is omitted deduct \$5.10

No. 7223

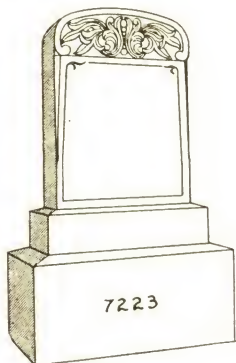

Die.....1.6 x 0.6 x 2. 0. .1.6
 Base.....1.9 x 0.9 x 0. 5. .0.7
 B. Base.....2.2 x 1.2 x 0.10. .2.1

Weight complete 700 lbs.; no B. B. 325 lbs.

- C.....\$50.50
- D.....45.75
- F.....43.75
- G.....42.75
- H.....41.50
- I.....40.50
- K.....39.00
- L.....37.50

If B. B. is omitted deduct \$7.50

No. 7224

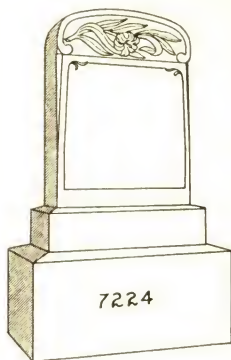

Die.....1.6 x 0.6 x 2. 0. .1.6
 Base.....1.9 x 0.9 x 0. 5. .0.7
 B. Base.....2.2 x 1.2 x 0.10. .2.1

Weight complete 700 lbs.; no B. B. 325 lbs.

- C.....\$48.25
- D.....43.50
- F.....41.50
- G.....40.50
- H.....39.25
- I.....38.25
- K.....36.75
- L.....35.25

If B. B. is omitted deduct \$7.50

No. 7223¹/₄

Die.....1.6 x 0.4 x 2. 0. .1. 0
 Base.....1.9 x 0.7 x 0. 4. .0. 4
 B. Base.....2.2 x 1.0 x 0.10. .1.10

Weight complete 525 lbs.; no B. B. 195 lbs.

- C.....\$38.00
- D.....35.00
- F.....33.50
- G.....33.00
- H.....32.25
- I.....31.50
- K.....30.50
- L.....29.50

If B. B. is omitted deduct \$6.60

No. 7224¹/₄

Die.....1.6 x 0.4 x 2. 0. .1. 0
 Base.....1.9 x 0.7 x 0. 4. .0. 4
 B. Base.....2.2 x 1.0 x 0.10. .1.10

Weight complete 525 lbs.; no B. B. 195 lbs.

- C.....\$36.75
- D.....33.75
- F.....32.25
- G.....31.75
- H.....31.00
- I.....30.25
- K.....29.25
- L.....28.25

If B. B. is omitted deduct \$6.60

No. 7225

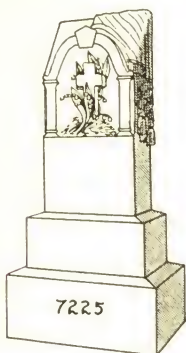

Die.....1.5 x 0.10 x 3.0..3.7
 Base.....1.8 x 1.2 x 0.8..1.4
 B. Base....2.2 x 1.8 x 1.0..3.7
 Weight complete 1450 lbs.; no B. B. 805 lbs.

C.....	\$121.00
D.....	109.00
F.....	105.00
G.....	102.00
H.....	100.00
I.....	97.00
K.....	93.50
L.....	90.00

If B. B. is omitted deduct \$12.55

No. 7225¹/₄

Die.....1.3 x 0.8 x 2.8..2.3
 Base.....1.6 x 1.0 x 0.8..1.0
 B. Base....1.10 x 1.4 x 0.10..2.0
 Weight complete 900 lbs.; no B. B. 540 lbs.

C.....	\$90.00
D.....	82.50
F.....	79.50
G.....	78.00
H.....	76.00
I.....	74.50
K.....	72.00
L.....	69.50

If B. B. is omitted deduct \$7.20

No. 7225¹/₂

Die.....1.1 x 0.6 x 2.6..1.4
 Base.....1.4 x 0.10 x 0.6..0.7
 B. Base....1.8 x 1.2 x 0.10..1.7
 Weight complete 600 lbs.; no B. B. 315 lbs.

C.....	\$63.50
D.....	59.00
F.....	57.00
G.....	56.00
H.....	55.00
I.....	54.00
K.....	52.50
L.....	51.50

If B. B. is omitted deduct \$5.70

No. 7227

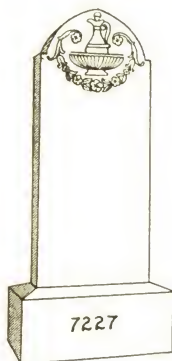

Die.....1.10 x 0.8 x 3.10..4.8
 B. Base....2.4 x 1.2 x 1.0..2.9
 Weight complete 1250 lbs.; no B. B. 755 lbs.

C.....	\$79.50
D.....	69.00
F.....	64.00
G.....	62.00
H.....	59.50
I.....	57.00
K.....	53.50
L.....	50.00

If B. B. is omitted deduct \$9.90
 Face polished; balance sand finished

No. 7227¹/₄

Die.....1.8 x 0.6 x 3.8..3.1
 B. Base....2.2 x 1.0 x 1.0..2.2
 Weight complete 900 lbs.; no B. B. 510 lbs.

C.....	\$56.50
D.....	49.25
F.....	46.25
G.....	44.75
H.....	43.00
I.....	41.50
K.....	39.25
L.....	37.00

If B. B. is omitted deduct \$7.80
 Face polished; no B. B. 510 lbs.

No. 7227¹/₂

Die.....1.6 x 0.4 x 3.6..1.9
 B. Base....2.0 x 0.10 x 1.0..1.8
 Weight complete 575 lbs.; no B. B. 275 lbs.

C.....	\$35.75
D.....	31.75
F.....	30.25
G.....	29.25
H.....	28.25
I.....	27.50
K.....	26.25
L.....	24.75

If B. B. is omitted deduct \$6.00
 Face polished; balance sand finished

No. 7228

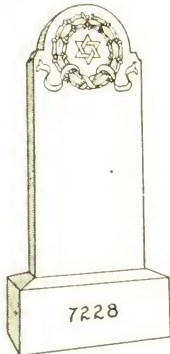

Die.....1.10 x 0.8 x 3.10..4.8
 B. Base....2.4 x 1.2 x 1.0..2.9
 Weight complete 1250 lbs.; no B. B. 755 lbs.

C.....	\$82.00
D.....	71.50
F.....	66.50
G.....	64.50
H.....	62.00
I.....	59.50
K.....	56.00
L.....	52.50

If B. B. is omitted deduct \$9.90
 Face polished; balance sand finished

No. 7228¹/₄

Die.....1.8 x 0.6 x 3.8..3.1
 B. Base....2.2 x 1.0 x 1.0..2.2
 Weight complete 900 lbs.; no B. B. 510 lbs.

C.....	\$58.00
D.....	50.50
F.....	47.50
G.....	46.00
H.....	44.25
I.....	42.75
K.....	40.50
L.....	38.25

If B. B. is omitted deduct \$7.80
 Face polished; balance sand finished

No. 7228¹/₂

Die.....1.6 x 0.4 x 3.6..1.9
 B. Base....2.0 x 0.10 x 1.0..1.8
 Weight complete 575 lbs.; no B. B. 275 lbs.

C.....	\$36.25
D.....	32.25
F.....	30.75
G.....	29.75
H.....	28.75
I.....	28.00
K.....	26.75
L.....	25.25

If B. B. is omitted deduct \$6.00
 Face polished; balance sand finished

No. 7229

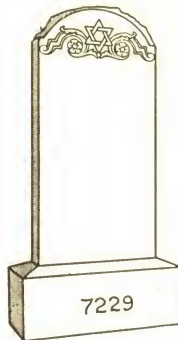

Die.....1.10 x 0.8 x 3.8..4.6
 B. Base....2.4 x 1.2 x 1.2..3.2
 Weight complete 1300 lbs.; no B. B. 730 lbs.

C.....	\$76.00
D.....	66.00
F.....	61.50
G.....	59.00
H.....	57.00
I.....	54.50
K.....	51.00
L.....	47.75

If B. B. is omitted deduct \$11.10
 Face only polished

No. 7229¹/₄

Die.....1.8 x 0.6 x 3.6..2.11
 B. Base....2.2 x 1.0 x 1.0..2.2
 Weight complete 875 lbs.; no B. B. 485 lbs.

C.....	\$50.50
D.....	43.75
F.....	40.75
G.....	39.25
H.....	37.75
I.....	36.50
K.....	34.25
L.....	32.00

If B. B. is omitted deduct \$7.80
 Face only polished

No. 7229¹/₂

Die.....1.6 x 0.4 x 3.4..1.8
 B. Base....2.0 x 0.10 x 0.10..1.5
 Weight complete 550 lbs.; no B. B. 295 lbs.

C.....	\$31.00
D.....	27.25
F.....	25.75
G.....	24.75
H.....	24.00
I.....	23.25
K.....	22.00
L.....	20.75

If B. B. is omitted deduct \$5.10
 Face only polished

No. 7230

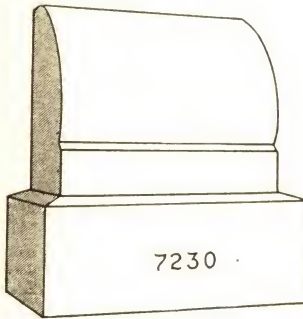

Die.....1.10 x 0.10 x 1.6..2.4
 B. Base...2.2 x 1.2 x 0.10..2.1
 Weight complete 700 lbs.; no B. B. 325 lbs.
 C.....\$46.50
 D.....41.25
 F.....38.75
 G.....37.75
 H.....36.50
 I.....35.25
 K.....33.50
 L.....31.75
 If B. B. is omitted deduct \$7.50

No. 7230¹/₄

Die.....1.8 x 0.8 x 1.4..1.6
 B. Base...2.0 x 1.0 x 0.8..1.4
 Weight complete 350 lbs.; no B. B. 110 lbs.
 C.....\$31.25
 D.....27.75
 F.....26.25
 G.....25.50
 H.....24.25
 I.....24.00
 K.....22.75
 L.....21.75
 If B. B. is omitted deduct \$4.80

No. 7230¹/₂

Die.....1.6 x 0.6 x 1.2..0.11
 B. Base...1.10 x 0.10 x 0.6..0.9
 Weight complete 275 lbs.; no B. B. 140 lbs.
 C.....\$19.50
 D.....17.50
 F.....16.50
 G.....16.00
 H.....15.50
 I.....15.25
 K.....14.50
 L.....13.75
 If B. B. is omitted deduct \$2.80

No. 7231

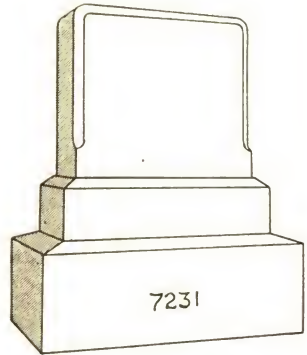

Die.....1.8 x 0.8 x 1.6..1.8
 Base.....1.11 x 0.11 x 0.6..0.11
 B. Base...2.4 x 1.4 x 0.10..2.7
 Weight complete 900 lbs.; no B. B. 435 lbs.
 C.....\$53.00
 D.....47.00
 F.....44.50
 G.....43.25
 H.....41.75
 I.....40.50
 K.....38.75
 L.....36.75
 If B. B. is omitted deduct \$9.30

No. 7231¹/₄

Die.....1.6 x 0.6 x 1.4..1.0
 Base.....1.9 x 0.9 x 0.5..0.7
 B. Base...2.2 x 1.2 x 0.10..2.1
 Weight complete 650 lbs.; no B. B. 275 lbs.
 C.....\$36.00
 D.....32.50
 F.....31.00
 G.....30.25
 H.....29.25
 I.....28.50
 K.....27.50
 L.....26.25
 If B. B. is omitted deduct \$7.50

No. 7231¹/₂

Die.....1.6 x 0.4 x 1.4..0.8
 Base.....1.9 x 0.7 x 0.5..0.5
 B. Base...2.2 x 1.0 x 0.10..1.10
 Weight complete 525 lbs.; no B. B. 195 lbs.
 C.....\$27.00
 D.....24.50
 F.....23.50
 G.....23.00
 H.....22.50
 I.....21.75
 K.....21.00
 L.....20.25
 If B. B. is omitted deduct \$6.60

No. 7236

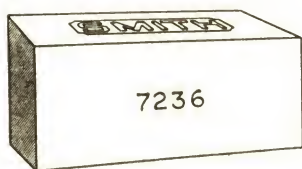

"M. M." finish

	Con- tents	D	F	I	K	L
2. 4x1. 2x1. 0	2. 9	\$35.25	\$30.75	\$29.50	\$27.50	\$25.50
2. 4x1. 2x0.10	2. 3	30.50	26.00	24.75	23.00	21.25
2. 0x1. 0x1. 0	2. 0	26.25	22.25	21.25	19.75	18.25
2. 0x1. 0x0.10	1. 8	22.25	19.00	18.25	17.00	15.75
2. 0x1. 0x0. 8	1. 4	19.00	16.25	15.50	14.50	13.50
2. 0x1. 0x0. 6	1. 0	15.25	13.25	12.75	12.00	11.25
1.10x1. 0x1. 0	1.10	23.75	20.00	19.00	17.75	16.50
1.10x1. 0x0.10	1. 6	20.75	17.75	17.00	15.75	14.50
1.10x1. 0x0. 8	1. 3	18.25	15.75	15.00	14.00	13.00
1.10x1. 0x0. 6	0.11	14.50	12.75	12.25	11.50	10.75
1.10x0.10x0.10	1. 3	18.25	15.75	15.00	14.00	13.00
1.10x0.10x0. 8	1. 0	15.25	13.25	12.75	12.00	11.25
1.10x0.10x0. 6	0. 9	12.00	10.50	10.00	9.50	9.00
1. 8x1. 0x1. 0	1. 8	21.75	18.50	17.75	16.50	15.25
1. 8x1. 0x0.10	1. 5	19.25	16.50	15.75	14.75	13.75
1. 8x1. 0x0. 8	1. 1	15.50	13.25	12.75	12.00	11.25
1. 8x1. 0x0. 6	0.10	13.50	11.75	11.25	10.50	9.75
1. 8x0.10x0.10	1. 2	16.75	14.50	14.00	13.00	12.00
1. 6x0.10x1. 0	1. 3	17.75	15.25	14.50	13.50	12.50
1. 6x0.10x0.10	1. 1	15.25	13.00	12.50	11.75	11.00
1. 6x0.10x0. 8	0.10	13.25	11.50	11.00	10.25	9.50
1. 6x0.10x0. 6	0. 8	11.00	9.75	9.50	9.00	8.50
1. 6x0. 8x0. 8	0. 8	10.50	9.25	9.00	8.50	8.00
1. 4x0.10x0.10	0.11	13.50	11.75	11.25	10.50	9.75
1. 4x0.10x0. 8	0. 9	11.75	10.25	9.75	9.25	8.75
1. 4x0.10x0. 6	0. 7	10.25	9.00	8.75	8.25	7.75
1. 4x0. 8x0.10	0. 9	12.50	10.75	10.25	9.50	8.75
1. 4x0. 8x0. 8	0. 7	9.50	8.25	8.00	7.50	7.00
1. 4x0. 8x0. 6	0. 5	7.25	6.50	6.25	6.00	5.75
1. 4x0. 6x0. 6	0. 4	6.50	5.75	5.50	5.25	5.00
1. 2x0. 6x0. 8	0. 5	7.00	6.25	6.00	5.75	5.50
1. 2x0. 6x0. 6	0. 4	6.25	5.50	5.25	5.00	4.75
1. 0x0.10x0. 8	0. 7	9.25	8.00	7.75	7.25	6.75
1. 0x0.10x0. 6	0. 5	6.75	6.00	5.75	5.50	5.25
1. 0x0. 8x0. 8	0. 5	6.75	6.00	5.75	5.50	5.25
1. 0x0. 8x0. 6	0. 4	6.25	5.50	5.25	5.00	4.75
1. 0x0. 6x0. 8	0. 4	6.25	5.50	5.25	5.00	4.75

No. 7237

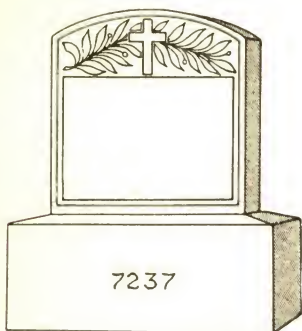

7237

Die.....1.2 x 0.6 x 1.2..0.8
 B. Base.....1.6 x 0.10 x 0.6..0.8
 Weight complete 240 lbs.; no B. B. 120 lbs.

- C.....\$16.00
 - D.....14.50
 - F.....14.00
 - G.....13.50
 - H.....13.25
 - I.....13.00
 - K.....12.50
 - L.....12.00
- If B. B. is omitted deduct \$2.50

No. 7237—A

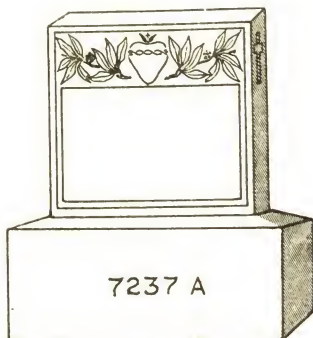

7237 A

Sizes and prices same as No. 7237.

No. 7237—B

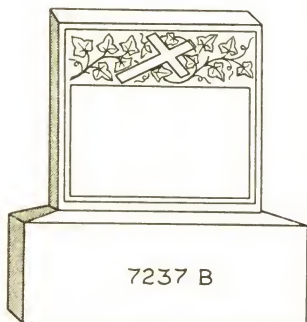

7237 B

Sizes and prices same as No. 7237.

No. 7237—C

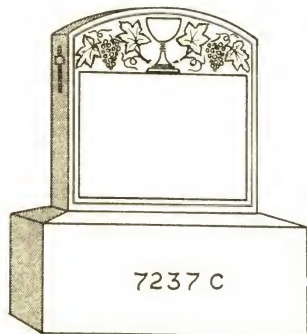

7237 C

Sizes and prices same as No. 7237.

No. 7237¹/₄

Die.....1.0 x 0.4 x 1.0..0.4
 B. Base.....1.4 x 0.8 x 0.6..0.5
 Weight complete 135 lbs.; no B. B. 60 lbs.

- C.....\$9.50
 - D.....8.75
 - F.....8.50
 - G.....8.25
 - H.....8.00
 - I.....7.75
 - K.....7.50
 - L.....7.25
- If B. B. is omitted deduct \$1.55

No. 7238

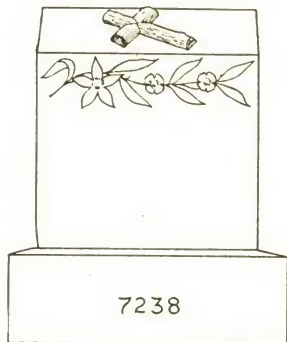

Die.....1.4 x 0.8 x 1.6..1.4
 B. Base.....1.8 x 1.0 x 0.6..0.10
 Weight complete 375 lbs.; no B. B. 225 lbs.

C.....	\$29.75
D.....	26.75
F.....	25.25
G.....	24.75
H.....	24.00
I.....	23.25
K.....	22.25
L.....	21.25

If B. B. is omitted deduct \$3.15
 Top and face polished

No. 7239

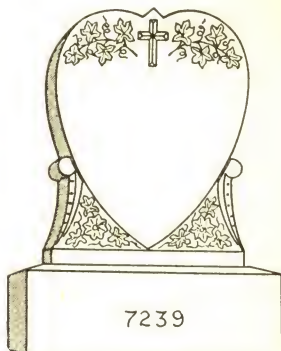

Die.....1.2 x 0.6 x 1.6..0.11
 B. Base.....1.6 x 0.10 x 0.6..0.8
 Weight complete 300 lbs.; no B. B. 180 lbs.

C.....	\$22.00
D.....	20.00
F.....	19.00
G.....	18.50
H.....	18.00
I.....	17.75
K.....	17.00
L.....	16.25

If B. B. is omitted deduct \$2.50
 Face only polished

No. 7239¹/₄

Die.....1.2 x 0.4 x 1.6..0.7
 B. Base.....1.6 x 0.8 x 0.6..0.6
 Weight complete 225 lbs.; no B. B. 135 lbs.

C.....	\$16.75
D.....	15.50
F.....	15.00
G.....	14.75
H.....	14.25
I.....	14.00
K.....	13.75
L.....	13.25

If B. B. is omitted deduct \$1.90
 Face only polished

No. 7238¹/₄

Die.....1.4 x 0.6 x 1.6..1.0
 B. Base.....1.8 x 0.10 x 0.6..0.8
 Weight complete 275 lbs.; no B. B. 155 lbs.

C.....	\$23.50
D.....	21.25
F.....	20.25
G.....	19.75
H.....	19.25
I.....	18.75
K.....	18.00
L.....	17.25

If B. B. is omitted deduct \$2.50
 Top and face polished

No. 7239¹/₂

Die.....1.0 x 0.4 x 1.2..0.5
 B. Base.....1.4 x 0.8 x 0.6..0.5
 Weight complete 180 lbs.; no B. B. 105 lbs.

C.....	\$12.75
D.....	11.75
F.....	11.50
G.....	11.25
H.....	11.00
I.....	10.75
K.....	10.25
L.....	10.00

If B. B. is omitted deduct \$1.55
 Face only polished

No. 7240

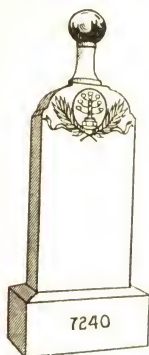

Ball & Pli. 0.10 x 0.10 x 1.6 . . 1.1
 Die. 1.10 x 0.10 x 3.8 . . 5.7
 B. Base. 2.4 x 1.4 x 1.0 . . 3.1
 Weight complete 1650 lbs.; no B. B. 1095 lbs.

- C. \$119.00
- D. 104.00
- F. 97.50
- G. 94.50
- H. 91.00
- I. 87.50
- K. 82.50
- L. 77.50

If B. B. is omitted deduct \$10.80
 Face polished; balance sand finished

No. 7240¹/₄

Ball & Pli. 0.8 x 0.8 x 1.4 . . 0.7
 Die. 1.8 x 0.8 x 3.6 . . 3.11
 B. Base. 2.2 x 1.2 x 1.0 . . 2.6
 Weight complete 1050 lbs.; no B. B. 600 lbs.

- C. \$84.00
- D. 74.00
- F. 69.50
- G. 67.00
- H. 65.00
- I. 62.50
- K. 59.00
- L. 56.00

If B. B. is omitted deduct \$9.00
 Face polished; balance sand finished

No. 7240¹/₂

Ball & Pli. 0.6 x 0.6 x 1.2 . . 0.4
 Die. 1.6 x 0.6 x 3.4 . . 2.6
 B. Base. 2.0 x 1.0 x 1.0 . . 2.0
 Weight complete 800 lbs.; no B. B. 440 lbs.

- C. \$57.00
- D. 50.50
- F. 47.75
- G. 46.50
- H. 45.00
- I. 43.50
- K. 41.50
- L. 39.25

If B. B. is omitted deduct \$7.20
 Face polished; balance sand finished

No. 7242

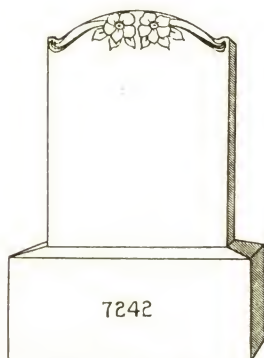

Die. 1.2 x 0.4 x 1.6 . . 0.7
 B. Base. 1.6 x 0.8 x 0.8 . . 0.8
 Weight complete 225 lbs.; no B. B. 105 lbs.

- C. \$15.00
- D. 13.75
- F. 13.25
- G. 13.00
- H. 12.50
- I. 12.25
- K. 12.00
- L. 11.50

If B. B. is omitted deduct \$2.50

No. 7242¹/₄

Die. 1.0 x 0.4 x 1.4 . . 0.5
 B. Base. 1.4 x 0.8 x 0.8 . . 0.7
 Weight complete 180 lbs.; no B. B. 75 lbs.

- C. \$11.75
- D. 10.75
- F. 10.50
- G. 10.25
- H. 10.00
- I. 9.75
- K. 9.25
- L. 9.00

If B. B. is omitted deduct \$2.20

No. 7243

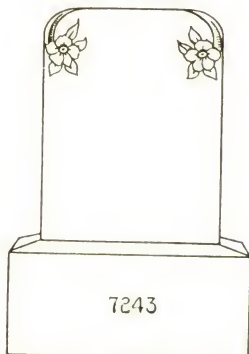

Sizes and prices same as No. 7242

No. 7244

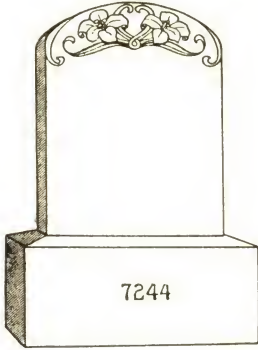

Sizes and prices same as No. 7242.

No. 7246

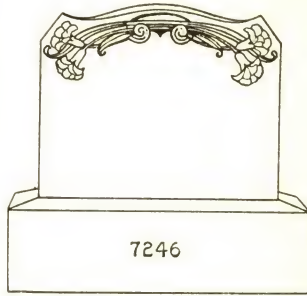

Sizes and prices same as No. 7245.

No. 7245

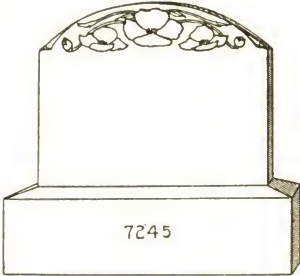

Die.....1. 6 x 0.4 x 1.2 . . 0.7
 B. Base.....1.10 x 0.8 x 0.6 . . 0.7
 Weight complete 210 lbs.; no B. B. 105 lbs.
 C.....\$15.50
 D.....14.25
 F.....13.75
 G.....13.50
 H.....13.00
 I.....12.75
 K.....12.50
 L.....12.00
 If B. B. is omitted deduct \$2.20

No. 7245¹/₄

Die.....1.4 x 0.4 x 1.0 . . 0.5
 B. Base.....1.8 x 0.8 x 0.6 . . 0.7
 Weight complete 180 lbs.; no B. B. 75 lbs.
 C.....\$12.75
 D.....11.75
 F.....11.50
 G.....11.25
 H.....11.00
 I.....10.75
 K.....10.25
 L.....10.00
 If B. B. is omitted deduct \$2.20

No. 7247

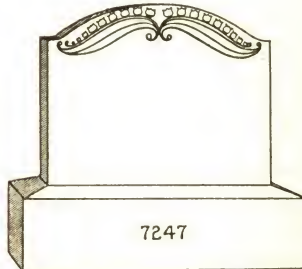

Sizes and prices same as No. 7245.

No. 7253

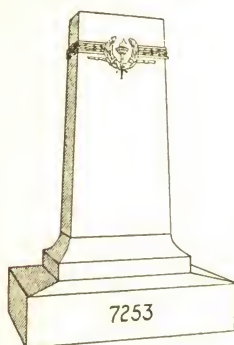

Die.....2.4 x 1. 2 x 5. 0..13.7
 Base.....3.0 x 1.10 x 0.10.. 4.7
 B.Ba. (S.S.) 4.4 x 3. 2 x 1. 2..16.0

Weight complete 5600 lbs.

- C.....\$449.00
- D..... 408.00
- F..... 390.00
- G..... 381.00
- H..... 372.00
- I..... 363.00
- K..... 349.00
- L..... 335.00

"M. M." finish

No. 7254

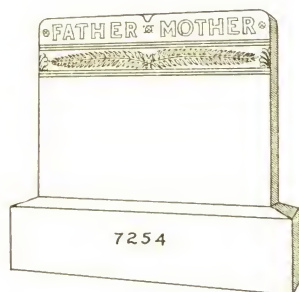

Die.....2.8 x 0.6 x 2. 0..2.8
 B. Base.....3.2 x 1.0 x 0.10..2.8

Weight complete 925 lbs.; no B. B. 445 lbs.

- C.....\$52.00
- D..... 46.00
- F..... 43.50
- G..... 42.00
- H..... 40.75
- I..... 39.50
- K..... 37.50
- L..... 35.50

If B. B. is omitted deduct \$9.60
 Prices do not include lettering

No. 7253¹/₄

Die.....2.4 x 1.0 x 5. 0..11.8
 Base.....3.0 x 1.8 x 0.10.. 4.2
 B.Ba. (S.S.) 4.4 x 3.0 x 1. 2..15.2

Weight complete 5000 lbs.

- C.....\$409.00
- D..... 373.00
- F..... 357.00
- G..... 349.00
- H..... 341.00
- I..... 333.00
- K..... 321.00
- L..... 310.00

"M. M." finish

No. 7254¹/₄

Die.....2.8 x 0. 4 x 2. 0..1.9
 B. Base.....3.2 x 0.10 x 0.10..2.2

Weight complete 675 lbs.; no B. B. 285 lbs.

- C.....\$37.75
- D..... 34.00
- F..... 32.00
- G..... 31.25
- H..... 30.25
- I..... 29.50
- K..... 28.25
- L..... 26.75

If B. B. is omitted deduct \$7.80
 Prices do not include lettering

No. 7255

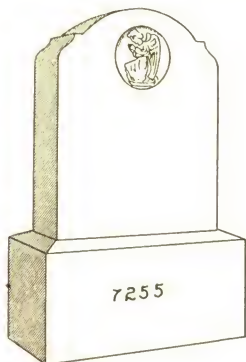

Die.....1.6 x 0.6 x 1.10..1.5
 B. Base.....2.0 x 1.0 x 0.10..1.8
 Weight complete 555 lbs.; no B. B. 255 lbs.

- C.....\$46.75
- D.....43.50
- F.....42.00
- G.....41.25
- H.....40.50
- I.....40.00
- K.....38.75
- L.....37.75

If B. B. is omitted deduct \$6.00

No. 7255¹/₄

Die.....1.4 x 0.6 x 1.8..1.1
 B. Base.....1.8 x 0.10 x 0.8..0.11
 Weight complete 360 lbs.; no B. B. 195 lbs.

- C.....\$38.50
- D.....36.00
- F.....35.00
- G.....34.50
- H.....33.75
- I.....33.25
- K.....32.50
- L.....31.75

If B. B. is omitted deduct \$3.45

No. 7255¹/₂

Die.....1.4 x 0.4 x 1.8..0.9
 B. Base.....1.8 x 0.8 x 0.8..0.9
 Weight complete 270 lbs.; no B. B. 135 lbs.

- C.....\$31.75
- D.....30.25
- F.....29.25
- G.....29.00
- H.....28.50
- I.....28.25
- K.....27.75
- L.....27.00

If B. B. is omitted deduct \$2.80

No. 7256

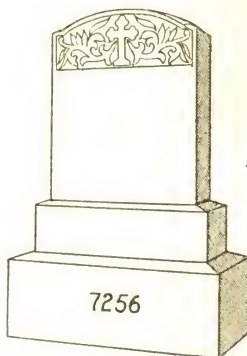

Die.....1.6 x 0.6 x 2.0..1.6
 Base.....1.9 x 0.9 x 0.5..0.7
 B. Base.....2.2 x 1.2 x 0.10..2.1
 Weight complete 725 lbs.; no B. B. 350 lbs.

- C.....\$44.50
- D.....39.75
- F.....37.75
- G.....36.75
- H.....35.50
- I.....34.75
- K.....33.00
- L.....31.50

If B. B. is omitted deduct \$7.50

No. 7256¹/₄

Die.....1.6 x 0.4 x 2.0..1.0
 Base.....1.9 x 0.7 x 0.4..0.4
 B. Base.....2.2 x 1.0 x 0.10..1.10
 Weight complete 550 lbs.; no B. B. 220 lbs.

- C.....\$32.50
- D.....29.50
- F.....28.00
- G.....27.50
- H.....26.75
- I.....26.00
- K.....25.00
- L.....24.00

If B. B. is omitted deduct \$6.60

No. 7258

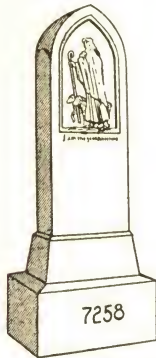

Die.....1.6 x 0.10 x 3.8..4.7
 Base.....1.9 x 1. 1 x 0.8..1.3
 B. Base.....2.4 x 1. 8 x 1.2..4.6
 Weight complete 1700 lbs.; no B. B. 890 lbs.

G.....\$117.00
 H.....114.00
 I.....111.00
 K.....107.00
 L.....103.00
 If B. B. is omitted deduct \$15.75

No. 7258¹/₄

Die.....1.4 x 0.10 x 3.6..3.11
 Base.....1.7 x 1. 1 x 0.8..1.2
 B. Base.....2.0 x 1. 6 x 1.0..3.0
 Weight complete 1500 lbs.; no B. B. 960 lbs.

G.....\$103.00
 H.....100.00
 I.....98.00
 K.....94.00
 L.....90.00
 If B. B. is omitted deduct \$10.80

No. 7258¹/₂

Die.....1.4 x 0. 8 x 3.6..3.1
 Base.....1.7 x 0.11 x 0.8..1.0
 B. Base.....2.0 x 1. 4 x 1.0..2.8
 Weight complete 1150 lbs.; no B. B. 670 lbs.

G.....\$90.50
 H.....88.50
 I.....86.50
 K.....83.50
 L.....80.00
 If B. B. is omitted deduct \$9.60

No. 7258³/₄

Die.....1. 2 x 0.6 x 3. 4..1.11
 Base.....1. 5 x 0.9 x 0. 8..0. 9
 B. Base.....1.10 x 1.2 x 0.10..1. 9
 Weight complete 725 lbs.; no B. B. 410 lbs.

G.....\$68.50
 H.....67.00
 I.....65.50
 K.....63.50
 L.....61.50
 If B. B. is omitted deduct \$6.30

No. 7263

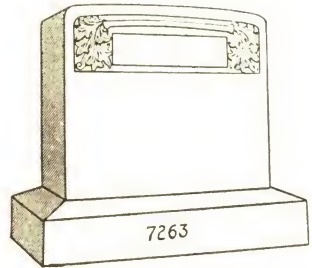

Die.....2.0 x 1.0 x 1.8..3. 4
 B. Base.....2.6 x 1.6 x 0.6..1.11
 Weight complete 900 lbs.; no B. B. 555 lbs.

C.....\$69.00
 D.....61.50
 F.....58.50
 G.....56.50
 H.....55.00
 I.....53.50
 K.....51.00
 L.....48.25
 If B. B. is omitted deduct \$6.90

No. 7263¹/₄

Die.....2.0 x 0.10 x 1.8..2.9
 B. Base.....2.6 x 1. 4 x 0.6..1.8
 Weight complete 750 lbs.; no B. B. 450 lbs.

C.....\$60.50
 D.....54.50
 F.....51.50
 G.....50.50
 H.....48.75
 I.....47.50
 K.....45.50
 L.....43.25
 If B. B. is omitted deduct \$6.00

No. 7263¹/₂

Die.....2.0 x 0.8 x 1.8..2.3
 B. Base.....2.6 x 1.2 x 0.6..1.6
 Weight complete 625 lbs.; no B. B. 355 lbs.

C.....\$52.00
 D.....47.25
 F.....44.75
 G.....43.75
 H.....42.50
 I.....41.50
 K.....39.75
 L.....38.00
 If B. B. is omitted deduct \$5.40

No. 7267

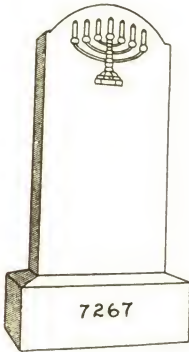

Die.....1.10 x 0.8 x 3.8..4.6
 B. Base.....2.4 x 1.2 x 1.2..3.2
 Weight complete 1350 lbs.; no B. B. 780 lbs.

- C.....\$78.50
- D.....68.50
- F.....64.00
- G.....61.50
- H.....59.50
- I.....57.00
- K.....53.50
- L.....50.50

If B. B. is omitted deduct \$11.10
 Face polished; balance sand finished

No. 7267¹/₄

Die.....1.8 x 0.6 x 3.6..2.11
 B. Base.....2.2 x 1.0 x 1.0..2.2
 Weight complete 900 lbs.; no B. B. 510 lbs.

- C.....\$54.00
- D.....47.25
- F.....44.25
- G.....42.50
- H.....41.25
- I.....40.00
- K.....37.75
- L.....35.50

If B. B. is omitted deduct \$7.80
 Face polished; balance sand finished

No. 7267¹/₂

Die.....1.6 x 0.4 x 3.4..1.8
 B. Base.....2.0 x 0.10 x 0.10..1.5
 Weight complete 550 lbs.; no B. B. 295 lbs.

- C.....\$32.75
- D.....29.00
- F.....27.50
- G.....26.50
- H.....25.75
- I.....25.00
- K.....23.75
- L.....22.50

If B. B. is omitted deduct \$5.10
 Face polished; balance sand finished

No. 7268

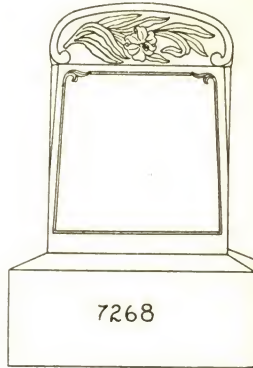

Die.....1.6 x 0.6 x 2.0..1.6
 B. Base.....2.0 x 1.0 x 0.10..1.8
 Weight complete 550 lbs.; no B. B. 250 lbs.

- C.....\$38.50
- D.....35.00
- F.....33.50
- G.....32.75
- H.....32.00
- I.....31.25
- K.....30.00
- L.....29.00

If B. B. is omitted deduct \$6.00

No. 7268¹/₄

Die.....1.6 x 0.4 x 2.0..1.0
 B. Base.....2.0 x 0.10 x 0.10..1.5
 Weight complete 425 lbs.; no B. B. 170 lbs.

- C.....\$31.00
- D.....28.75
- F.....27.75
- G.....27.25
- H.....26.75
- I.....26.25
- K.....25.50
- L.....24.75

If B. B. is omitted deduct \$5.10

No. 7269

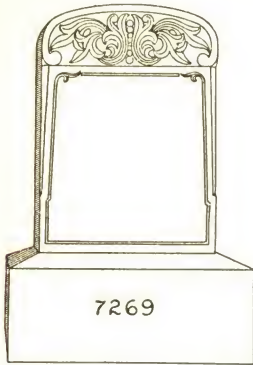

Die.....1.6 x 0.6 x 2. 0..1.6
 B. Base.....2.0 x 1.0 x 0.10..1.8
 Weight complete 550 lbs.; no B. B. 250 lbs.

- C.....\$39.50
 - D.....36.00
 - F.....34.50
 - G.....33.75
 - H.....33.00
 - I.....32.25
 - K.....31.00
 - L.....30.00
- If B. B. is omitted deduct \$6.00

No. 7270

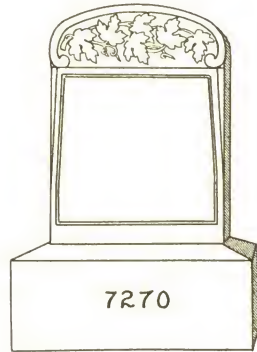

Die.....1.6 x 0.6 x 2. 0..1.6
 B. Base.....2.0 x 1.0 x 0.10..1.8
 Weight complete 550 lbs.; no B. B. 250 lbs.

- C.....\$40.50
 - D.....37.00
 - F.....35.50
 - G.....34.75
 - H.....34.00
 - I.....33.25
 - K.....32.00
 - L.....31.00
- If B. B. is omitted deduct \$6.00

No. 7269¹/₄

Die.....1.6 x 0. 4 x 2. 0..1.0
 B. Base.....2.0 x 0.10 x 0.10..1.5
 Weight complete 425 lbs.; no B. B. 170 lbs.

- C.....\$31.75
 - D.....29.50
 - F.....28.50
 - G.....28.00
 - H.....27.50
 - I.....27.00
 - K.....26.25
 - L.....25.50
- If B. B. is omitted deduct \$5.10

No. 7270¹/₄

Die.....1.6 x 0. 4 x 2. 0..1.0
 B. Base.....2.0 x 0.10 x 0.10..1.5
 Weight complete 425 lbs.; no B. B. 170 lbs.

- C.....\$33.50
 - D.....31.25
 - F.....30.25
 - G.....29.75
 - H.....29.25
 - I.....28.75
 - K.....28.00
 - L.....27.25
- If B. B. is omitted deduct \$5.10

No. 7271

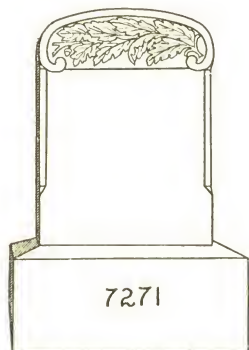

Die.....1.6 x 0.6 x 2. 0..1.6
 B. Base.....2.0 x 1.0 x 0.10..1.8
 Weight complete 550 lbs.; no B. B. 250 lbs.

- C.....\$39.50
 - D.....36.00
 - F.....34.50
 - G.....33.75
 - H.....33.00
 - I.....32.25
 - K.....31.00
 - L.....30.00
- If B. B. is omitted deduct \$6.00

No. 7273

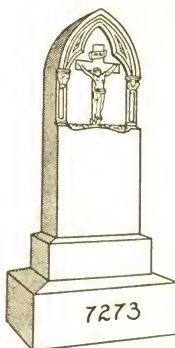

Die.....1. 6 x 0.10 x 4.0..5.0
 Base.....1.10 x 1. 2 x 0.8..1.5
 B. Base.....2. 6 x 1.10 x 1.0..4.7
 Weight complete 1800 lbs.; no B. B. 975 lbs.

- C.....\$178.00
 - D.....163.00
 - F.....157.00
 - G.....154.00
 - H.....150.00
 - I.....147.00
 - K.....142.00
 - L.....138.00
- If B. B. is omitted deduct \$16.05

No. 7273¹/₄

Die.....1.4 x 0.8 x 3.6..3.1
 Base.....1.8 x 1.0 x 0.8..1.1
 B. Base.....2.2 x 1.6 x 1.0..3.3
 Weight complete 1200 lbs.; no B. B. 615 lbs.

- C.....\$130.00
 - D.....121.00
 - F.....117.00
 - G.....115.00
 - H.....113.00
 - I.....111.00
 - K.....108.00
 - L.....104.00
- If B. B. is omitted deduct \$11.40

No. 7273¹/₂

Die.....1.2 x 0. 6 x 3. 0..1.9
 Base.....1.6 x 0.10 x 0. 6..0.8
 B. Base.....2.0 x 1. 4 x 0.10..2.3
 Weight complete 800 lbs.; no B. B. 395 lbs.

- C.....\$97.00
 - D.....91.50
 - F.....89.50
 - G.....88.00
 - H.....87.00
 - I.....85.50
 - K.....84.00
 - L.....82.00
- If B. B. is omitted deduct \$8.10

No. 7271¹/₄

Die.....1.6 x 0. 4 x 2. 0..1.0
 B. Base.....2.0 x 0.10 x 0.10..1.5
 Weight complete 425 lbs.; no B. B. 170 lbs.

- C.....\$31.75
 - D.....29.50
 - F.....28.50
 - G.....28.00
 - H.....27.50
 - I.....27.00
 - K.....26.25
 - L.....25.50
- If B. B. is omitted deduct \$5.10

No. 7276

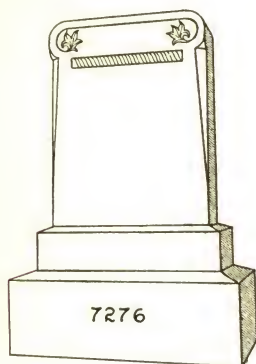

Die.....1.6 x 0.6 x 2.0 .1.6
 Base.....1.9 x 0.9 x 0.5 .0.7
 B. Base.....2.2 x 1.2 x 0.10 .2.1
 Weight complete 750 lbs.; no B. B. 375 lbs.

C.....\$45.75
 D.....41.00
 F.....39.00
 G.....38.00
 H.....36.75
 I.....35.75
 K.....34.25
 L.....32.75

If B. B. is omitted deduct \$7.50

No. 7284

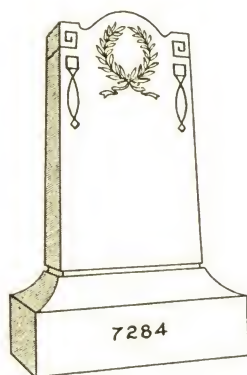

Die.....2.0 x 0.10 x 3.4 .5.7
 Base.....2.10 x 1.8 x 1.2 .5.6

Weight complete 1800 lbs.

C.....\$171.00
 D.....146.00
 F.....135.00
 G.....129.00
 H.....123.00
 I.....117.00
 K.....109.00
 L.....101.00

Sand finished

No. 7284¹/₄

Die.....1.10 x 0.8 x 3.2 .3.10
 Base.....2.8 x 1.6 x 1.0 .4.0

Weight complete 1300 lbs.

C.....\$128.00
 D.....110.00
 F.....102.00
 G.....98.00
 H.....94.00
 I.....90.00
 K.....84.00
 L.....78.00

Sand finished

No. 7276¹/₄

Die.....1.6 x 0.4 x 2.0 .1.0
 Base.....1.9 x 0.7 x 0.4 .0.4
 B. Base.....2.2 x 1.0 x 0.10 .1.10

Weight complete 550 lbs.; no B. B. 220 lbs.

C.....\$34.50
 D.....31.50
 F.....30.00
 G.....29.50
 H.....28.75
 I.....28.00
 K.....27.00
 L.....26.00

If B. B. is omitted deduct \$6.60

No. 7284¹/₂

Die.....1.8 x 0.6 x 3.0 .2.6
 Base.....2.4 x 1.2 x 1.0 .2.9

Weight complete 875 lbs.

C.....\$87.00
 D.....75.00
 F.....70.00
 G.....67.50
 H.....65.00
 I.....62.50
 K.....58.50
 L.....54.50

Sand finished

No. 7292

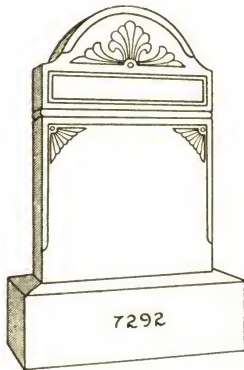

Die.....2. 4 x 0.10 x 3.10..7.5
 B. Base....2.10 x 1. 4 x 1. 0..3.9
 Weight complete 1900 lbs.; no B. B. 1225 lbs.

C.....	\$131.00
D.....	115.00
F.....	107.00
G.....	104.00
H.....	100.00
I.....	96.00
K.....	90.50
L.....	85.00

If B. B. is omitted deduct \$13.15
 Face polished; balance sand finished

No. 7292¹/₄

Die.....2.2 x 0.8 x 3.6..5.1
 B. Base....2.8 x 1.2 x 1.0..3.1
 Weight complete 1400 lbs.; no B. B. 845 lbs.

C.....	\$96.50
D.....	85.00
F.....	80.00
G.....	77.50
H.....	75.00
I.....	72.50
K.....	68.50
L.....	64.50

If B. B. is omitted deduct \$10.80
 Face polished; balance sand finished

No. 7292¹/₂

Die.....2.0 x 0.6 x 3. 2..3.2
 B. Base....2.6 x 1.0 x 0.10..2.1
 Weight complete 900 lbs.; no B. B. 525 lbs.

C.....	\$65.00
D.....	58.00
F.....	55.00
G.....	53.50
H.....	52.00
I.....	50.00
K.....	47.75
L.....	45.50

If B. B. is omitted deduct \$7.50
 Face polished; balance sand finished

No. 7293

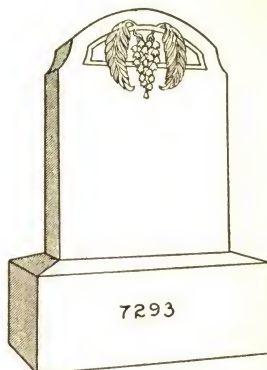

Die.....1.8 x 0.8 x 2.4..2.7
 B. Base....2.2 x 1.2 x 1.0..2.6
 Weight complete 875 lbs.; no B. B. 425 lbs.

C.....	\$61.00
D.....	55.50
F.....	52.50
G.....	51.50
H.....	50.00
I.....	48.75
K.....	47.00
L.....	45.00

If B. B. is omitted deduct \$9.00

No. 7293¹/₄

Die.....1.6 x 0.6 x 2. 0..1.6
 B. Base....2.0 x 1.0 x 0.10..1.8
 Weight complete 550 lbs.; no B. B. 250 lbs.

C.....	\$40.75
D.....	37.25
F.....	35.75
G.....	35.00
H.....	34.25
I.....	33.50
K.....	32.25
L.....	31.25

If B. B. is omitted deduct \$6.00

No. 7293¹/₂

Die.....1.6 x 0. 4 x 2. 0..1.0
 B. Base....2.0 x 0.10 x 0.10..1.5
 Weight complete 425 lbs.; no B. B. 170 lbs.

C.....	\$32.75
D.....	30.50
F.....	29.50
G.....	29.00
H.....	28.50
I.....	28.00
K.....	27.25
L.....	26.50

If B. B. is omitted deduct \$5.10

No. 7295

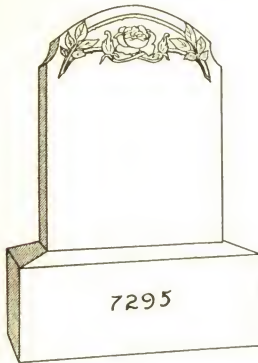

Die.....1.8 x 0.8 x 2.4...2.7
 B. Base.....2.2 x 1.2 x 1.0...2.6
 Weight complete 875 lbs.; no B. B. 425 lbs.
 C.....\$60.50
 D.....55.00
 F.....52.00
 G.....51.00
 H.....49.50
 I.....48.25
 K.....46.50
 L.....44.50
 If B. B. is omitted deduct \$9.00

No. 7296

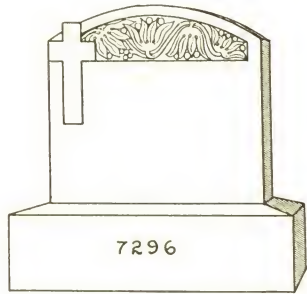

Die.....1.6 x 0.6 x 1.4...1.0
 B. Base.....1.10 x 0.10 x 0.8...1.0
 Weight complete 325 lbs.; no B. B. 145 lbs.
 C.....\$32.25
 D.....30.00
 F.....29.00
 G.....28.50
 H.....28.00
 I.....27.50
 K.....26.75
 L.....26.00
 If B. B. is omitted deduct \$3.75

No. 7295¹/₄

Die.....1.6 x 0.6 x 2.0...1.6
 B. Base.....2.0 x 1.0 x 0.10...1.8
 Weight complete 550 lbs.; no B. B. 250 lbs.
 C.....\$40.25
 D.....36.75
 F.....35.25
 G.....34.50
 H.....33.75
 I.....33.00
 K.....31.75
 L.....30.75
 If B. B. is omitted deduct \$6.00

No. 7296¹/₄

Die.....1.4 x 0.5 x 1.2...0.8
 B. Base.....1.8 x 0.9 x 0.6...0.8
 Weight complete 225 lbs.; no B. B. 105 lbs.
 C.....\$25.00
 D.....23.50
 F.....23.00
 G.....22.50
 H.....22.25
 I.....22.00
 K.....21.50
 L.....21.00
 If B. B. is omitted deduct \$2.50

No. 7295¹/₂

Die.....1.6 x 0.4 x 2.0...1.0
 B. Base.....2.0 x 0.10 x 0.10...1.5
 Weight complete 425 lbs.; no B. B. 170 lbs.
 C.....\$32.25
 D.....30.00
 F.....29.00
 G.....28.50
 H.....28.00
 I.....27.50
 K.....26.75
 L.....26.00
 If B. B. is omitted deduct \$5.10

No. 7296¹/₂

Die.....1.4 x 0.4 x 1.2...0.6
 B. Base.....1.8 x 0.8 x 0.6...0.7
 Weight complete 180 lbs.; no B. B. 75 lbs.
 C.....\$21.00
 D.....19.75
 F.....19.25
 G.....19.00
 H.....18.75
 I.....18.50
 K.....18.00
 L.....17.75
 If B. B. is omitted deduct \$2.20

No. 7297

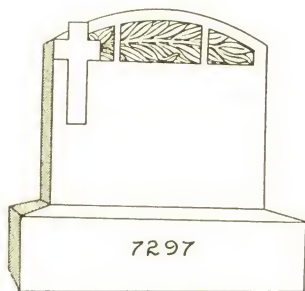

Die.....1.6 x 0.6 x 1.4 .1.0
 B. Base.....1.10 x 0.10 x 0.8 .1.0
 Weight complete 325 lbs.; no B. B. 145 lbs.

- C.....\$32.25
- D.....30.00
- F.....29.00
- G.....28.50
- H.....28.00
- I.....27.50
- K.....26.75
- L.....26.00

If B. B. is omitted deduct \$3.75

No. 7297¹/₄

Die.....1.4 x 0.5 x 1.2 .0.8
 B. Base.....1.8 x 0.9 x 0.6 .0.8
 Weight complete 225 lbs.; no B. B. 105 lbs.

- C.....\$25.00
- D.....23.50
- F.....23.00
- G.....22.50
- H.....22.25
- I.....22.00
- K.....21.50
- L.....21.00

If B. B. is omitted deduct \$2.50

No. 7297¹/₂

Die.....1.4 x 0.4 x 1.2 .0.6
 B. Base.....1.8 x 0.8 x 0.6 .0.7
 Weight complete 180 lbs.; no B. B. 75 lbs.

- C.....\$21.00
- D.....19.75
- F.....19.25
- G.....19.00
- H.....18.75
- I.....18.50
- K.....18.00
- L.....17.75

If B. B. is omitted deduct \$2.20

No. 7298

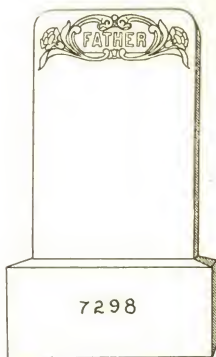

Die.....1.6 x 0.6 x 2.4 .1.9
 B. Base.....2.0 x 1.0 x 0.10 .1.8
 Weight complete 600 lbs.; no B. B. 300 lbs.

- C.....\$33.50
- D.....29.75
- F.....27.75
- G.....27.00
- H.....26.00
- I.....25.25
- K.....24.00
- L.....22.50

If B. B. is omitted deduct \$6.00
 Face polished; balance sand finished

No. 7298¹/₄

Die.....1.6 x 0.4 x 2.4 .1.2
 B. Base.....2.0 x 0.10 x 0.10 .1.5
 Weight complete 475 lbs.; no B. B. 220 lbs.

- C.....\$23.75
- D.....21.00
- F.....20.00
- G.....19.25
- H.....18.75
- I.....18.25
- K.....17.25
- L.....16.50

If B. B. is omitted deduct \$5.10
 Face polished; balance sand finished

No. 7299

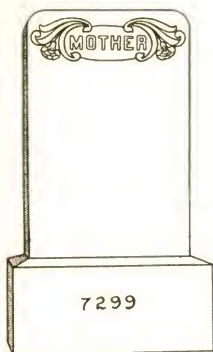

Die.....1.6 x 0.6 x 2.4..1.9
 B. Base.....2.0 x 1.0 x 0.10..1.8
 Weight complete 600 lbs.; no B. B. 300 lbs.

C.....	\$33.50
D.....	29.75
F.....	27.75
G.....	27.00
H.....	26.00
I.....	25.25
K.....	24.00
L.....	22.50

If B. B. is omitted deduct \$6.00
 Face polished; balance sand finished

No. 7299¹/₄

Die.....1.6 x 0.4 x 2.4..1.2
 B. Base.....2.0 x 0.10 x 0.10..1.5
 Weight complete 475 lbs.; no B. B. 220 lbs.

C.....	\$23.75
D.....	21.00
F.....	20.00
G.....	19.25
H.....	18.75
I.....	18.25
K.....	17.25
L.....	16.50

If B. B. is omitted deduct \$5.10
 Face polished; balance sand finished

No. 7300

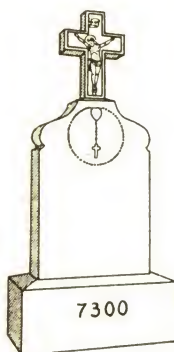

Cross.....1.0 x 0.4 x 1.4..0.5
 Die.....1.8 x 0.8 x 2.8..3.0
 B. Base.....2.2 x 1.2 x 1.0..2.6
 Weight complete 900 lbs.; no B. B. 450 lbs.

C.....	\$70.50
D.....	62.50
F.....	59.50
G.....	57.50
H.....	56.00
I.....	54.00
K.....	51.50
L.....	49.00

If B. B. is omitted deduct \$9.00

No. 7300¹/₄

Cross.....0.10 x 0.3 x 1.2..0.3
 Die.....1.6 x 0.6 x 2.6..1.11
 B. Base.....2.0 x 1.0 x 0.10..1.8
 Weight complete 600 lbs.; no B. B. 300 lbs.

C.....	\$49.75
D.....	44.75
F.....	42.75
G.....	41.50
H.....	40.50
I.....	39.50
K.....	37.75
L.....	36.25

If B. B. is omitted deduct \$6.00

No. 7300¹/₂

Cross.....0.10 x 0.3 x 1.2..0.3
 Die.....1.6 x 0.4 x 2.4..1.2
 B. Base.....2.0 x 0.10 x 0.10..1.5
 Weight complete 450 lbs.; no B. B. 195 lbs.

C.....	\$37.00
D.....	33.75
F.....	32.25
G.....	31.50
H.....	30.75
I.....	30.25
K.....	29.00
L.....	28.00

If B. B. is omitted deduct \$5.10

No. 7303

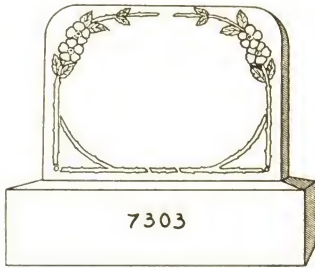

Die.....1. 6 x 0.4 x 1.2 .0.7
 B. Base.....1.10 x 0.8 x 0.6 .0.7
 Weight complete 210 lbs.; no B. B. 105 lbs.

- C.....\$15.00
- D.....13.75
- F.....13.25
- G.....13.00
- H.....12.50
- I.....12.25
- K.....12.00
- L.....11.50

If B. B. is omitted deduct \$2.20

No. 7303¹/₄

Die.....1.4 x 0.4 x 1.0 .0.5
 B. Base.....1.8 x 0.8 x 0.6 .0.7
 Weight complete 180 lbs.; no B. B. 75 lbs.

- C.....\$12.50
- D.....11.50
- F.....11.25
- G.....11.00
- H.....10.75
- I.....10.50
- K.....10.00
- L.....9.75

If B. B. is omitted deduct \$2.20

No. 7304

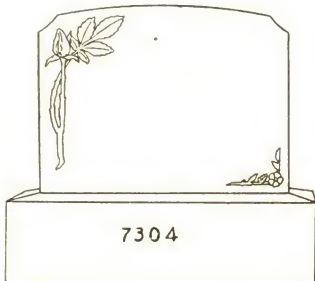

Sizes and prices same as No. 7303.

No. 7305

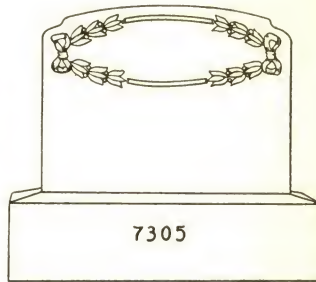

Sizes and prices same as No. 7303.

No. 7306

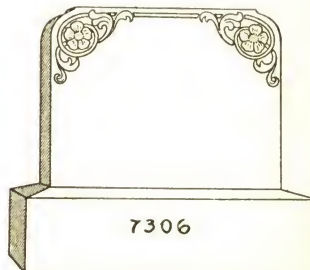

Sizes and prices same as No. 7303.

No. 7313

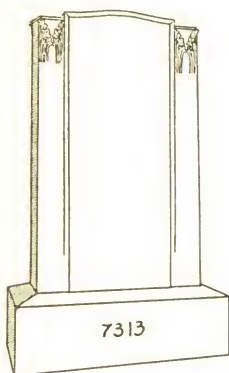

Die.....2.6 x 1.0 x 4.0..10.0
 B. Base.....3.2 x 1.8 x 1.2.. 6.2

Weight complete 2700 lbs.; no B.B.1590 lbs.

C.....	\$196.00
D.....	173.00
F.....	163.00
G.....	158.00
H.....	153.00
I.....	148.00
K.....	141.00
L.....	133.00

If B. B. is omitted deduct \$21.60

No. 7313¹/₄

Die.....2.6 x 0.10 x 4.0..8.4
 B. Base.....3.2 x 1.6 x 1.0..4.9

Weight complete 2200 lbs.; no B.B.1345 lbs.

C.....	\$166.00
D.....	147.00
F.....	139.00
G.....	135.00
H.....	131.00
I.....	126.00
K.....	120.00
L.....	114.00

If B. B. is omitted deduct \$16.65

No. 7313¹/₂

Die.....2.6 x 0.8 x 4.0..6.8
 B. Base.....3.0 x 1.2 x 1.0..3.6

Weight complete 1750 lbs.; no B.B.1120 lbs.

C.....	\$138.00
D.....	123.00
F.....	117.00
G.....	113.00
H.....	110.00
I.....	107.00
K.....	102.00
L.....	96.50

If B. B. is omitted deduct \$12.25

No. 7321

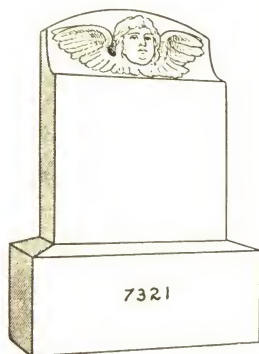

Die.....1.2 x 0.6 x 1.6..0.11
 B. Base.....1.6 x 0.10 x 0.8..0.10

Weight complete 315 lbs.; no B. B. 165 lbs.

C.....	\$44.25
D.....	42.25
F.....	41.25
G.....	40.75
H.....	40.25
I.....	40.00
K.....	39.25
L.....	38.50

If B. B. is omitted deduct \$3.15

No. 7321¹/₄

Die.....1.0 x 0.6 x 1.6..0.9
 B. Base.....1.4 x 0.10 x 0.8..0.9

Weight complete 270 lbs.; no B. B. 135 lbs.

C.....	\$41.25
D.....	39.75
F.....	38.75
G.....	38.50
H.....	38.00
I.....	37.75
K.....	37.25
L.....	36.50

If B. B. is omitted deduct \$2.80

No. 7322

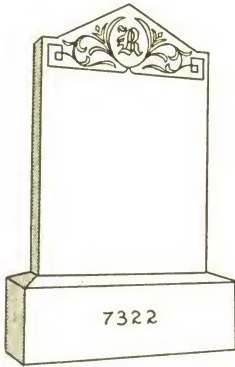

Die.....2.0 x 0.6 x 3. 0..3.0
 B. Base.....2.6 x 1.0 x 0.10..2.1
 Weight complete 915 lbs.; no B. B. 540 lbs.
 D.....\$54.00
 G.....49.50
 H.....48.00
 I.....46.50
 K.....43.25
 L.....42.00
 If B. B. is omitted deduct \$7.50

No. 7322¹/₄

Die.....1.10 x 0.6 x 2.10..2. 7
 B. Base...2. 4 x 1.0 x 0.10..1.11
 Weight complete 810 lbs.; no B. B. 465 lbs.
 D.....\$46.50
 G.....42.75
 H.....41.25
 I.....40.00
 K.....38.25
 L.....36.25
 If B. B. is omitted deduct \$6.90

No. 7322¹/₂

Die.....1.8 x 0.6 x 2. 8..2. 3
 B. Base...2.2 x 1.0 x 0.10..1.10
 Weight complete 735 lbs.; no B. B. 405 lbs.
 D.....\$40.50
 G.....37.00
 H.....35.75
 I.....34.75
 K.....33.00
 L.....31.25
 If B. B. is omitted deduct \$6.60

No. 7322³/₄

Die.....1.6 x 0.6 x 2. 6..1.11
 B. Base...2.0 x 1.0 x 0.10..1. 8
 Weight complete 645 lbs.; no B. B. 345 lbs.
 D.....\$34.50
 G.....31.50
 H.....30.50
 I.....29.75
 K.....28.25
 L.....26.75
 If B. B. is omitted deduct \$6.00

No. 7323

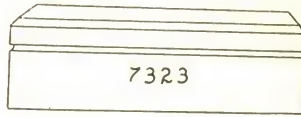

Die.....2.0 x 1.0 x 0.6..1.0
 Weight complete 180 lbs.
 C.....\$18.00
 D.....15.75
 F.....14.75
 G.....14.25
 H.....13.75
 I.....13.25
 K.....12.50
 L.....11.75
 Top only polished

No. 7323¹/₄

Die.....1.8 x 1.0 x 0.6..0.10
 Weight complete 150 lbs.
 C.....\$14.75
 D.....13.00
 F.....12.00
 G.....11.75
 H.....11.25
 I.....10.75
 K.....10.25
 L.....9.50
 Top only polished

No. 7323¹/₂

Die.....1.10 x 0.10 x 0.6..0.9
 Weight complete 135 lbs.
 C.....\$13.50
 D.....12.00
 F.....11.00
 G.....10.75
 H.....10.25
 I.....10.00
 K.....9.50
 L.....8.75
 Top only polished

No. 7323³/₄

Die.....1.6 x 0.10 x 0.6..0.8
 Weight complete 120 lbs.
 C.....\$11.75
 D.....10.25
 F.....9.75
 G.....9.25
 H.....9.00
 I.....8.75
 K.....8.25
 L.....7.75
 Top only polished

No. 7323—A

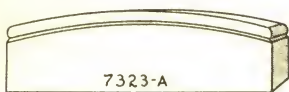

Die.....2.0 x 1.0 x 0.6..1.0
Weight complete 180 lbs.

C.....	\$19.00
D.....	16.75
F.....	15.75
G.....	15.25
H.....	14.75
I.....	14.25
K.....	13.50
L.....	12.75

Top only polished

No. 7323—B

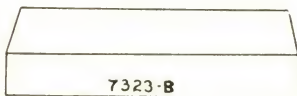

Die.....2.0 x 1.0 x 0.6..1.0
Weight complete 180 lbs.

C.....	\$15.50
D.....	13.25
F.....	12.25
G.....	11.75
H.....	11.25
I.....	10.75
K.....	10.00
L.....	9.25

Top only polished

No. 7323¹/₄—A

Die.....1.8 x 1.0 x 0.6..0.10
Weight complete 150 lbs.

C.....	\$15.75
D.....	14.00
F.....	13.00
G.....	12.75
H.....	12.25
I.....	11.75
K.....	11.25
L.....	10.50

Top only polished

No. 7323¹/₄—B

Die.....1.8 x 1.0 x 0.6..0.10
Weight complete 150 lbs.

C.....	\$12.75
D.....	11.00
F.....	10.00
G.....	9.75
H.....	9.25
I.....	8.75
K.....	8.25
L.....	7.50

Top only polished

No. 7323¹/₂—A

Die.....1.10 x 0.10 x 0.6..0.9
Weight complete 135 lbs.

C.....	\$14.50
D.....	13.00
F.....	12.00
G.....	11.75
H.....	11.25
I.....	11.00
K.....	10.50
L.....	9.75

Top only polished

No. 7323¹/₂—B

Die.....1.10 x 0.10 x 0.6..0.9
Weight complete 135 lbs.

C.....	\$12.00
D.....	10.50
F.....	9.50
G.....	9.25
H.....	8.75
I.....	8.50
K.....	8.00
L.....	7.25

Top only polished

No. 7323³/₄—A

Die.....1.6 x 0.10 x 0.6..0.8
Weight complete 120 lbs.

C.....	\$12.75
D.....	11.25
F.....	10.75
G.....	10.25
H.....	10.00
I.....	9.75
K.....	9.25
L.....	8.75

Top only polished

No. 7323³/₄—B

Die.....1.6 x 0.10 x 0.6..0.8
Weight complete 120 lbs.

C.....	\$10.50
D.....	9.00
F.....	8.50
G.....	8.00
H.....	7.75
I.....	7.50
K.....	7.00
L.....	6.50

Top only polished

No. 7323—C

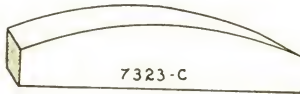

Die.....2.0 x 1.0 x 0.6...1.0

Weight complete 180 lbs.

C.....	\$18.00
D.....	15.75
F.....	14.75
G.....	14.25
H.....	13.75
I.....	13.25
K.....	12.50
L.....	11.75

Top only polished

No. 7323¹/₄—C

Die.....1.8 x 1.0 x 0.6...0.10

Weight complete 150 lbs.

C.....	\$14.75
D.....	13.00
F.....	12.00
G.....	11.75
H.....	11.25
I.....	10.75
K.....	10.25
L.....	9.50

Top only polished

No. 7323¹/₂—C

Die.....1.10 x 0.10 x 0.6...0.9

Weight complete 135 lbs.

C.....	\$13.50
D.....	12.00
F.....	11.00
G.....	10.75
H.....	10.25
I.....	10.00
K.....	9.50
L.....	8.75

Top only polished

No. 7323³/₄—C

Die.....1.6 x 0.10 x 0.6...0.8

Weight complete 120 lbs.

C.....	\$11.75
D.....	10.25
F.....	9.75
G.....	9.25
H.....	9.00
I.....	8.75
K.....	8.25
L.....	7.75

Top only polished

No. 7323—D

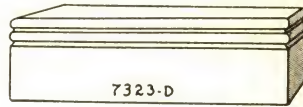

Die.....2.0 x 1.0 x 0.6...1.0

Weight complete 180 lbs.

C.....	\$18.75
D.....	16.50
F.....	15.50
G.....	15.00
H.....	14.50
I.....	14.00
K.....	13.25
L.....	12.50

Top only polished

No. 7323¹/₄—D

Die.....1.8 x 1.0 x 0.6...0.10

Weight complete 150 lbs.

C.....	\$15.50
D.....	13.75
F.....	12.75
G.....	12.50
H.....	12.00
I.....	11.50
K.....	11.00
L.....	10.25

Top only polished

No. 7323¹/₂—D

Die.....1.10 x 0.10 x 0.6...0.9

Weight complete 135 lbs.

C.....	\$14.25
D.....	12.75
F.....	11.75
G.....	11.50
H.....	11.00
I.....	10.75
K.....	10.25
L.....	9.50

Top only polished

No. 7323³/₄—D

Die.....1.6 x 0.10 x 0.6...0.8

Weight complete 120 lbs.

C.....	\$12.50
D.....	11.00
F.....	10.50
G.....	10.00
H.....	9.75
I.....	9.50
K.....	9.00
L.....	8.50

Top only polished

No. 7323—E

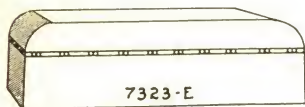

Die.....2.0 x 1.0 x 0.6...1.0
Weight complete 180 lbs.

C.....	\$20.50
D.....	18.25
F.....	17.25
G.....	16.75
H.....	16.25
I.....	15.75
K.....	15.00
L.....	14.25

Top only polished

No. 7323¹/₄—E

Die.....1.8 x 1.0 x 0.6...0.10
Weight complete 150 lbs.

C.....	\$18.25
D.....	16.50
F.....	15.50
G.....	15.25
H.....	14.75
I.....	14.25
K.....	13.75
L.....	13.00

Top only polished

No. 7323¹/₂—E

Die.....1.10 x 0.10 x 0.6...0.9
Weight complete 135 lbs.

C.....	\$16.25
D.....	14.75
F.....	13.75
G.....	13.50
H.....	13.00
I.....	12.75
K.....	12.25
L.....	11.50

Top only polished

No. 7323³/₄—E

Die.....1.6 x 0.10 x 0.6...0.8
Weight complete 120 lbs.

C.....	\$14.50
D.....	13.00
F.....	12.50
G.....	12.00
H.....	11.75
I.....	11.50
K.....	11.00
L.....	10.50

Top only polished

No. 7324

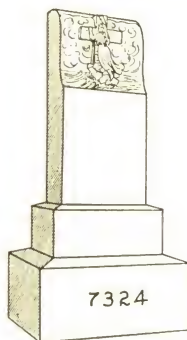

Die.....1.4 x 1.0 x 2.10...3.2
Base.....1.8 x 1.2 x 0.8...1.4
B. Base....2.2 x 1.8 x 1.0...3.7
Weight complete 1455 lbs.; no B. B. 810 lbs.

C.....	\$107.00
D.....	97.00
F.....	92.50
G.....	90.00
H.....	88.00
I.....	85.50
K.....	82.00
L.....	79.00

If B. B. is omitted deduct \$12.55

No. 7324¹/₄

Die.....1.2 x 0.8 x 2.8...2.1
Base.....1.6 x 1.0 x 0.8...1.0
B. Base....2.0 x 1.6 x 1.0...3.0
Weight complete 1095 lbs.; no B. B. 555 lbs.

C.....	\$83.50
D.....	76.50
F.....	73.50
G.....	72.00
H.....	70.50
I.....	69.00
K.....	66.50
L.....	64.00

If B. B. is omitted deduct \$10.80

No. 7324¹/₂

Die.....1.0 x 0.6 x 2.6...1.3
Base.....1.4 x 0.10 x 0.6...0.7
B. Base....1.10 x 1.4 x 0.10...2.0
Weight complete 690 lbs.; no B. B. 330 lbs.

C.....	\$59.50
D.....	55.50
F.....	53.50
G.....	52.50
H.....	51.50
I.....	50.50
K.....	49.50
L.....	48.00

If B. B. is omitted deduct \$7.20

No. 7325

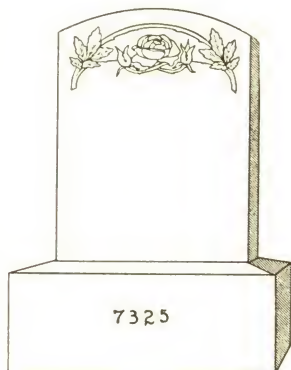

Die.....1.6 x 0.6 x 2. 0. 1.6
 B. Base.....2.0 x 1.0 x 0.10. 1.8
 Weight complete 550 lbs.; no B. B. 250 lbs.

C.....	\$39.75
D.....	36.25
F.....	34.75
G.....	34.00
H.....	33.25
I.....	32.50
K.....	31.25
L.....	30.25

If B. B. is omitted deduct \$6.00

No. 7326

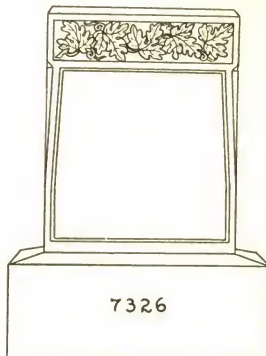

Die.....1.6 x 0.6 x 2. 0. 1.6
 B. Base.....2.0 x 1.0 x 0.10. 1.8
 Weight complete 550 lbs.; no B. B. 250 lbs.

C.....	\$39.75
D.....	36.25
F.....	34.75
G.....	34.00
H.....	33.25
I.....	32.50
K.....	31.25
L.....	30.25

If B. B. is omitted deduct \$6.00

No. 7325¹/₄

Die.....1.6 x 0. 4 x 2. 0. 1.0
 B. Base.....2.0 x 0.10 x 0.10. 1.5
 Weight complete 425 lbs.; no B. B. 170 lbs.

C.....	\$31.75
D.....	29.50
F.....	28.50
G.....	28.00
H.....	27.50
I.....	27.00
K.....	26.25
L.....	25.50

If B. B. is omitted deduct \$5.10

No. 7326¹/₄

Die.....1.6 x 0. 4 x 2. 0. 1.0
 B. Base.....2.0 x 0.10 x 0.10. 1.5
 Weight complete 425 lbs.; no B. B. 170 lbs.

C.....	\$31.75
D.....	29.50
F.....	28.50
G.....	28.00
H.....	27.50
I.....	27.00
K.....	26.25
L.....	25.50

If B. B. is omitted deduct \$5.10

No. 7327

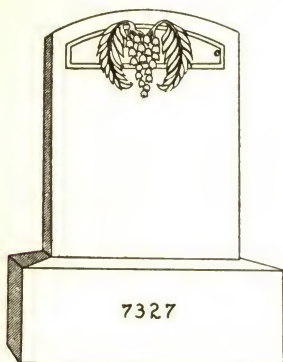

Die.....1.6 x 0.6 x 2. 0..1.6
 B. Base.....2.0 x 1.0 x 0.10..1.8
 Weight complete 550 lbs.; no B. B. 250 lbs.

C.....	\$39.75
D.....	36.25
F.....	34.75
G.....	34.00
H.....	33.25
I.....	32.50
K.....	31.25
L.....	30.25

If B. B. is omitted deduct \$6.00

No. 7332

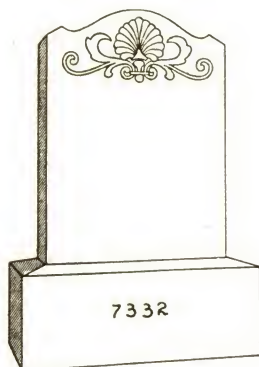

Die.....2. 4 x 0.10 x 2.8..5.2
 B. Base.....2.10 x 1. 4 x 1.0..3.9
 Weight complete 1550 lbs.; no B. B. 875 lbs.

C.....	\$94.00
D.....	82.50
F.....	77.50
G.....	75.00
H.....	72.50
I.....	69.50
K.....	66.00
L.....	62.00

If B. B. is omitted deduct \$13.15

No. 7332¹/₄

Die.....2.0 x 0.8 x 2.6..3. 4
 B. Base.....2.6 x 1.2 x 1.0..2.11
 Weight complete 1100 lbs.; no B. B. 575 lbs.

C.....	\$65.50
D.....	58.00
F.....	55.00
G.....	53.00
H.....	51.50
I.....	49.75
K.....	47.25
L.....	44.75

If B. B. is omitted deduct \$10.50

No. 7327¹/₄

Die.....1.6 x 0. 4 x 2. 0..1.0
 B. Base.....2.0 x 0.10 x 0.10..1.5
 Weight complete 425 lbs.; no B. B. 170 lbs.

C.....	\$31.75
D.....	29.50
F.....	28.50
G.....	28.00
H.....	27.50
I.....	27.00
K.....	26.25
L.....	25.50

If B. B. is omitted deduct \$5.10

No. 7332¹/₂

Die.....1.8 x 0.6 x 2. 4..1.11
 B. Base.....2.2 x 1.0 x 0.10..1.10
 Weight complete 650 lbs.; no B. B. 320 lbs.

C.....	\$39.25
D.....	35.00
F.....	33.00
G.....	32.00
H.....	31.00
I.....	30.25
K.....	28.75
L.....	27.25

If B. B. is omitted deduct \$6.60

No. 7336

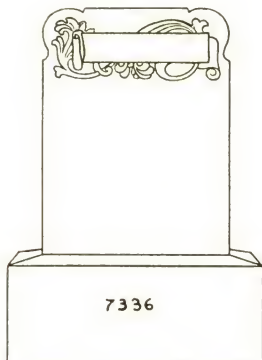

Die.....1.6 x 0.6 x 2. 0..1.6
 B. Base.....2.0 x 1.0 x 0.10..1.8
 Weight complete 550 lbs.; no B. B. 250 lbs.

C.....	\$36.00
D.....	32.50
F.....	31.00
G.....	30.25
H.....	29.50
I.....	28.75
K.....	27.50
L.....	26.50

If B. B. is omitted deduct \$6.00

No. 7337

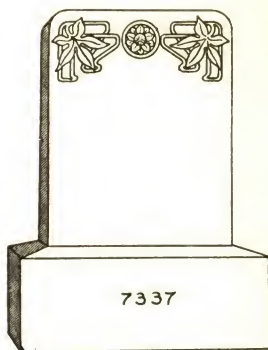

Die.....1.6 x 0.6 x 2. 0..1.6
 B. Base.....2.0 x 1.0 x 0.10..1.8
 Weight complete 550 lbs.; no B. B. 250 lbs.

C.....	\$34.50
D.....	31.00
F.....	29.50
G.....	28.75
H.....	28.00
I.....	27.25
K.....	26.00
L.....	25.00

If B. B. is omitted deduct \$6.00

No. 7336¹/₄

Die.....1.6 x 0.4 x 2. 0..1.0
 B. Base.....2.0 x 0.10 x 0.10..1.5
 Weight complete 425 lbs.; no B. B. 170 lbs.

C.....	\$28.75
D.....	26.50
F.....	25.50
G.....	25.00
H.....	24.50
I.....	24.00
K.....	23.25
L.....	22.50

If B. B. is omitted deduct \$5.10

No. 7337¹/₄

Die.....1.6 x 0.4 x 2. 0..1.0
 B. Base.....2.0 x 0.10 x 0.10..1.5
 Weight complete 425 lbs.; no B. B. 170 lbs.

C.....	\$26.25
D.....	24.00
F.....	23.00
G.....	22.50
H.....	22.00
I.....	21.50
K.....	20.75
L.....	20.00

If B. B. is omitted deduct \$5.10

No. 7338

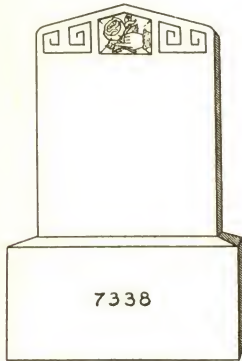

Die.....1.6 x 0.8 x 2.0 . 2.0
 B. Base.....2.0 x 1.2 x 1.0 . 2.4
 Weight complete 800 lbs.; no B. B. 360 lbs.

C.....	\$53.00
D.....	48.25
F.....	46.25
G.....	45.25
H.....	44.25
I.....	43.25
K.....	41.75
L.....	40.25

If B. B. is omitted deduct \$8.40

No. 7338¹/₄

Die.....1.4 x 0. 6 x 1.10 . 1. 3
 B. Base....1.8 x 0.10 x 0. 8 . 0.11
 Weight complete 390 lbs.; no B. B. 225 lbs.

C.....	\$35.50
D.....	32.75
F.....	31.25
G.....	30.75
H.....	30.00
I.....	29.50
K.....	28.50
L.....	27.50

If B. B. is omitted deduct \$3.45

No. 7338¹/₂

Die.....1.2 x 0. 6 x 1.6 . 0.11
 B. Base....1.6 x 0.10 x 0.8 . 0.10
 Weight complete 315 lbs.; no B. B. 165 lbs.

C.....	\$29.75
D.....	27.75
F.....	26.75
G.....	26.25
H.....	25.75
I.....	25.50
K.....	24.75
L.....	24.00

If B. B. is omitted deduct \$3.15

No. 7339

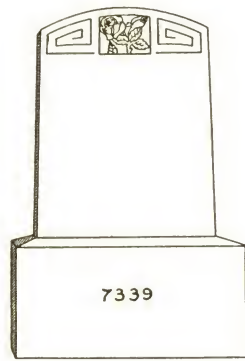

Die.....1.6 x 0.8 x 2.0 . 2.0
 B. Base.....2.0 x 1.2 x 1.0 . 2.4
 Weight complete 800 lbs.; no B. B. 360 lbs.

C.....	\$53.00
D.....	48.25
F.....	46.25
G.....	45.25
H.....	44.25
I.....	43.25
K.....	41.75
L.....	40.25

If B. B. is omitted deduct \$8.40

No. 7339¹/₄

Die.....1.4 x 0. 6 x 1.10 . 1. 3
 B. Base....1.8 x 0.10 x 0. 8 . 0.11
 Weight complete 390 lbs.; no B. B. 225 lbs.

C.....	\$35.50
D.....	32.75
F.....	31.25
G.....	30.75
H.....	30.00
I.....	29.50
K.....	28.50
L.....	27.50

If B. B. is omitted deduct \$3.45

No. 7339¹/₂

Die.....1.2 x 0. 6 x 1.6 . 0.11
 B. Base....1.6 x 0.10 x 0.8 . 0.10
 Weight complete 315 lbs.; no B. B. 165 lbs.

C.....	\$29.75
D.....	27.75
F.....	26.75
G.....	26.25
H.....	25.75
I.....	25.50
K.....	24.75
L.....	24.00

If B. B. is omitted deduct \$3.15

No. 7340

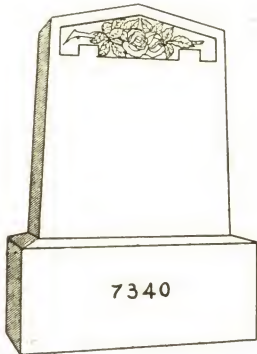

7340

Die.....1.6 x 0.8 x 2.0..2.0
 B. Base.....2.0 x 1.2 x 1.0..2.4
 Weight complete 800 lbs.; no B. B. 360 lbs.

C.....	\$57.50
D.....	53.00
F.....	51.00
G.....	50.00
H.....	49.00
I.....	48.00
K.....	46.50
L.....	45.00

If B. B. is omitted deduct \$8.40

No. 7340¹/₄

Die.....1.4 x 0.6 x 1.10..1.3
 B. Base.....1.8 x 0.10 x 0.10..1.2
 Weight complete 435 lbs.; no B. B. 225 lbs.

C.....	\$40.25
D.....	37.50
F.....	36.00
G.....	35.50
H.....	34.75
I.....	34.25
K.....	33.25
L.....	32.25

If B. B. is omitted deduct \$4.20

No. 7340¹/₂

Die.....1.2 x 0.6 x 1.6..0.11
 B. Base.....1.6 x 0.10 x 0.8..0.10
 Weight complete 315 lbs.; no B. B. 165 lbs.

C.....	\$32.25
D.....	30.25
F.....	29.25
G.....	28.75
H.....	28.25
I.....	28.00
K.....	27.25
L.....	26.50

If B. B. is omitted deduct \$3.15

No. 7341

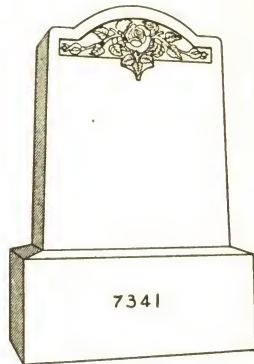

7341

Die.....1.6 x 0.8 x 2.0..2.0
 B. Base.....2.0 x 1.2 x 1.0..2.4
 Weight complete 800 lbs.; no B. B. 360 lbs.

C.....	\$58.50
D.....	54.00
F.....	52.00
G.....	51.00
H.....	50.00
I.....	49.00
K.....	47.50
L.....	46.00

If B. B. is omitted deduct \$8.40

No. 7341¹/₄

Die.....1.4 x 0.6 x 1.10..1.3
 B. Base.....1.8 x 0.10 x 0.10..1.2
 Weight complete 435 lbs.; no B. B. 225 lbs.

C.....	\$41.25
D.....	38.50
F.....	37.00
G.....	36.50
H.....	35.75
I.....	35.25
K.....	34.25
L.....	33.25

If B. B. is omitted deduct \$4.20

No. 7341¹/₂

Die.....1.2 x 0.6 x 1.6..0.11
 B. Base.....1.6 x 0.10 x 0.8..0.10
 Weight complete 315 lbs.; no B. B. 165 lbs.

C.....	\$33.25
D.....	31.25
F.....	30.25
G.....	29.75
H.....	29.25
I.....	29.00
K.....	28.25
L.....	27.00

If B. B. is omitted deduct \$3.15

No. 7342

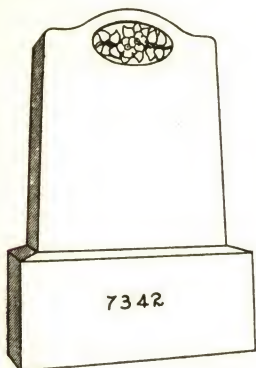

Die.....1.6 x 0.8 x 2.0 .. 2.0
 B. Base.....2.0 x 1.2 x 1.0 .. 2.4
 Weight complete 800 lbs.; no B. B. 360 lbs.

C.....	\$53.00
D.....	48.25
F.....	46.25
G.....	45.25
H.....	44.25
I.....	43.25
K.....	41.75
L.....	40.25

If B. B. is omitted deduct \$8.40

No. 7342¹/₄

Die.....1.4 x 0.6 x 1.10 .. 1.3
 B. Base.....1.8 x 0.10 x 0.10 .. 1.2
 Weight complete 435 lbs.; no B. B. 225 lbs.

C.....	\$36.75
D.....	34.00
F.....	32.50
G.....	32.00
H.....	31.25
I.....	30.75
K.....	29.75
L.....	28.75

If B. B. is omitted deduct \$4.20

No. 7342¹/₂

Die.....1.2 x 0.6 x 1.6 .. 0.11
 B. Base.....1.6 x 0.10 x 0.8 .. 0.10
 Weight complete 315 lbs.; no B. B. 165 lbs.

C.....	\$28.50
D.....	26.50
F.....	25.50
G.....	25.00
H.....	24.50
I.....	24.25
K.....	23.50
L.....	22.75

If B. B. is omitted deduct \$3.15

No. 7343

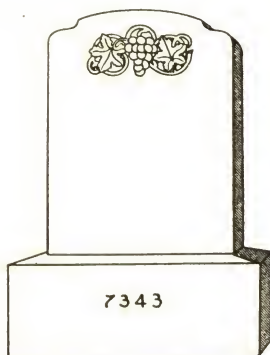

Die.....1.6 x 0.6 x 2.0 .. 1.6
 B. Base.....2.0 x 1.0 x 0.10 .. 1.8
 Weight complete 550 lbs.; no B. B. 250 lbs.

C.....	\$37.25
D.....	33.75
F.....	32.25
G.....	31.50
H.....	30.75
I.....	30.00
K.....	28.75
L.....	27.75

If B. B. is omitted deduct \$6.00

No. 7343¹/₄

Die.....1.6 x 0.4 x 2.0 .. 1.0
 B. Base.....2.0 x 0.10 x 0.10 .. 1.5
 Weight complete 425 lbs.; no B. B. 170 lbs.

C.....	\$28.75
D.....	26.50
F.....	25.50
G.....	25.00
H.....	24.50
I.....	24.00
K.....	23.25
L.....	22.50

If B. B. is omitted deduct \$5.10

No. 7344

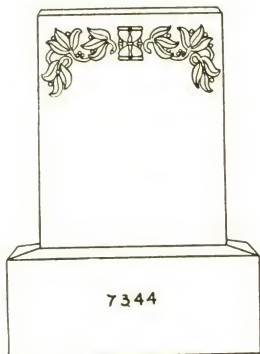

Die.....1.6 x 0.6 x 2. 0..1.6
 B. Base.....2.0 x 1.0 x 0.10..1.8

Weight complete 550 lbs.; no B. B. 250 lbs.

C.....	\$35.00
D.....	31.50
F.....	30.00
G.....	29.25
H.....	28.50
I.....	27.75
K.....	26.50
L.....	25.50

If B. B. is omitted deduct \$6.00

No. 7345

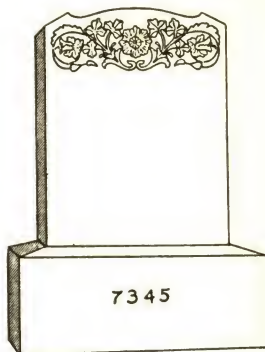

Die.....1.6 x 0.6 x 2. 0..1.6
 B. Base.....2.0 x 1.0 x 0.10..1.8

Weight complete 550 lbs.; no B. B. 250 lbs.

C.....	\$37.25
D.....	33.75
F.....	32.25
G.....	31.50
H.....	30.75
I.....	30.00
K.....	28.75
L.....	27.75

If B. B. is omitted deduct \$6.00

No. 7344¹/₄

Die.....1.6 x 0. 4 x 2. 0..1.0
 B. Base.....2.0 x 0.10 x 0.10..1.5

Weight complete 425 lbs.; no B. B. 170 lbs.

C.....	\$26.25
D.....	24.00
F.....	23.00
G.....	22.50
H.....	22.00
I.....	21.50
K.....	20.75
L.....	20.00

If B. B. is omitted deduct \$5.10

No. 7345¹/₄

Die.....1.6 x 0. 4 x 2. 0..1.0
 B. Base.....2.0 x 0.10 x 0.10..1.5

Weight complete 425 lbs.; no B. B. 170 lbs.

C.....	\$28.75
D.....	26.50
F.....	25.50
G.....	25.00
H.....	24.50
I.....	24.00
K.....	23.25
L.....	22.50

If B. B. is omitted deduct \$5.10

No. 7346

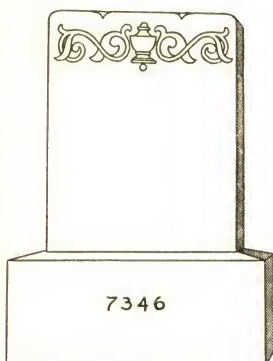

Die.....1.2 x 0.4 x 1.6..0.7
 B. Base.....1.6 x 0.8 x 0.8..0.8

Weight complete 225 lbs.; no B. B. 105 lbs.

C.....	\$14.75
D.....	13.50
F.....	13.00
G.....	12.75
H.....	12.25
I.....	12.00
K.....	11.75
L.....	11.25

If B. B. is omitted deduct \$2.50

No. 7347

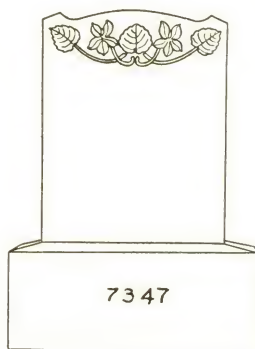

Die.....1.2 x 0.4 x 1.6..0.7
 B. Base.....1.6 x 0.8 x 0.8..0.8

Weight complete 225 lbs.; no B. B. 105 lbs.

C.....	\$14.75
D.....	13.50
F.....	13.00
G.....	12.75
H.....	12.50
I.....	12.00
K.....	11.75
L.....	11.25

If B. B. is omitted deduct \$2.50

No. 7346¹/₄

Die.....1.0 x 0.4 x 1.4..0.5
 B. Base.....1.4 x 0.8 x 0.8..0.7

Weight complete 180 lbs.; no B. B. 75 lbs.

C.....	\$11.50
D.....	10.50
F.....	10.00
G.....	9.75
H.....	9.75
I.....	9.50
K.....	9.00
L.....	8.75

If B. B. is omitted deduct \$2.20

No. 7347¹/₄

Die.....1.0 x 0.4 x 1.4..0.5
 B. Base.....1.4 x 0.8 x 0.8..0.7

Weight complete 180 lbs.; no B. B. 75 lbs.

C.....	\$11.50
D.....	10.50
F.....	10.00
G.....	9.75
H.....	9.75
I.....	9.50
K.....	9.00
L.....	8.75

If B. B. is omitted deduct \$2.20

No. 7348

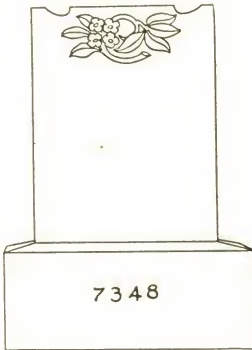

Die.....1.2 x 0.4 x 1.6 .07
 B. Base.....1.6 x 0.8 x 0.8 .08

Weight complete 225 lbs.; no B. B. 105 lbs.

- C.....\$14.75
- D.....13.50
- F.....13.00
- G.....12.75
- H.....12.50
- I.....12.00
- K.....11.75
- L.....11.25

If B. B. is omitted deduct \$2.50

No. 7349

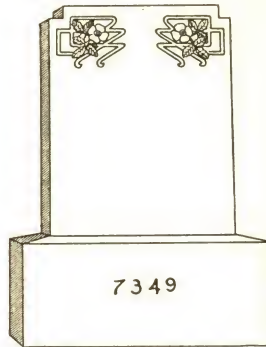

Die.....1.2 x 0.4 x 1.6 .07
 B. Base.....1.6 x 0.8 x 0.8 .08

Weight complete 225 lbs.; no B. B. 105 lbs.

- C.....\$14.75
- D.....13.50
- F.....13.00
- G.....12.75
- H.....12.50
- I.....12.00
- K.....11.75
- L.....11.25

If B. B. is omitted deduct \$2.50

No. 7348¹/₄

Die.....1.0 x 0.4 x 1.4 .05
 B. Base.....1.4 x 0.8 x 0.8 .07

Weight complete 180 lbs.; no B. B. 75 lbs.

- C.....\$11.50
- D.....10.50
- F.....10.00
- G.....9.75
- H.....9.75
- I.....9.50
- K.....9.00
- L.....8.75

If B. B. is omitted deduct \$2.20

No. 7349¹/₄

Die.....1.0 x 0.4 x 1.4 .05
 B. Base.....1.4 x 0.8 x 0.8 .07

Weight complete 180 lbs.; no B. B. 75 lbs.

- C.....\$11.50
- D.....10.50
- F.....10.00
- G.....9.75
- H.....9.75
- I.....9.50
- K.....9.00
- L.....8.75

If B. B. is omitted deduct \$2.20

No. 7350

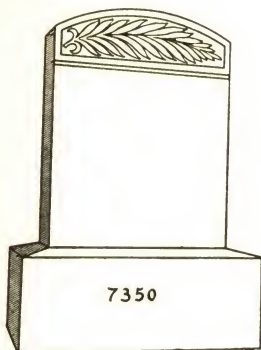

Die.....1.6 x 0.6 x 2. 0..1.6
 B. Base.....2.0 x 1.0 x 0.10..1.8

Weight complete 550 lbs.; no B. B. 250 lbs.

C.....	\$33.00
D.....	29.50
F.....	28.00
G.....	27.25
H.....	26.50
I.....	25.75
K.....	24.50
L.....	23.50

If B. B. is omitted deduct \$6.00

No. 7354

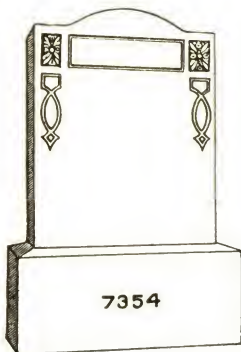

Die.....1.8 x 0.8 x 2.6..2.9
 B. Base.....2.2 x 1.2 x 1.0..2.6

Weight complete 900 lbs.; no B. B. 450 lbs.

C.....	\$60.50
D.....	54.50
F.....	51.50
G.....	50.50
H.....	48.75
I.....	47.50
K.....	45.50
L.....	43.25

If B. B. is omitted deduct \$9.00

No. 7354¹/₄

Die.....1.6 x 0.6 x 2. 0..1.6
 B. Base.....2.0 x 1.0 x 0.10..1.8

Weight complete 550 lbs.; no B. B. 250 lbs.

C.....	\$39.75
D.....	36.25
F.....	34.75
G.....	34.00
H.....	33.25
I.....	32.50
K.....	31.25
L.....	30.25

If B. B. is omitted deduct \$6.00

No. 7350¹/₄

Die.....1.6 x 0. 4 x 2. 0..1.0
 B. Base.....2.0 x 0.10 x 0.10..1.5

Weight complete 425 lbs.; no B. B. 170 lbs.

C.....	\$25.00
D.....	22.75
F.....	21.75
G.....	21.25
H.....	20.75
I.....	20.25
K.....	19.50
L.....	18.75

If B. B. is omitted deduct \$5.10

No. 7354¹/₂

Die.....1.6 x 0. 4 x 2. 0..1.0
 B. Base.....2.0 x 0.10 x 0.10..1.5

Weight complete 425 lbs.; no B. B. 170 lbs.

C.....	\$31.00
D.....	28.75
F.....	27.75
G.....	27.25
H.....	26.75
I.....	26.25
K.....	25.50
L.....	24.75

If B. B. is omitted deduct \$5.10

No. 7356

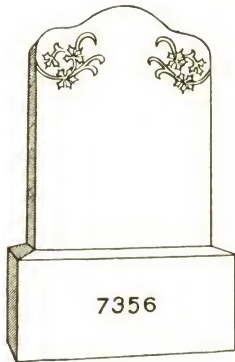

Die.....1.8 x 0.8 x 2.6..2.9
 B. Base.....2.2 x 1.2 x 1.0..2.6
 Weight complete 900 lbs.; no B. B. 450 lbs.

- C.....\$59.50
- D.....53.50
- F.....50.50
- G.....49.50
- H.....47.75
- I.....46.50
- K.....44.50
- L.....42.25

If B. B. is omitted deduct \$9.00

No. 7358

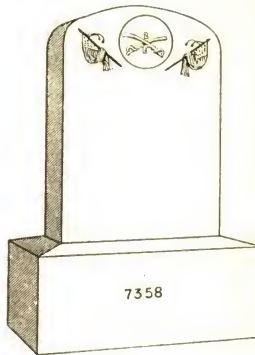

Die.....1.6 x 0.6 x 2.0..1.6
 B. Base.....2.0 x 1.0 x 0.10..1.8
 Weight complete 550 lbs.; no B. B. 250 lbs.

- C.....\$44.50
- D.....41.00
- F.....39.50
- G.....38.75
- H.....38.00
- I.....37.25
- K.....36.00
- L.....35.00

If B. B. is omitted deduct \$6.00

No. 7356¹/₄

Die.....1.6 x 0.6 x 2.0..1.6
 B. Base.....2.0 x 1.0 x 0.10..1.8
 Weight complete 550 lbs.; no B. B. 250 lbs.

- C.....\$38.75
- D.....35.25
- F.....33.75
- G.....33.00
- H.....32.25
- I.....31.50
- K.....30.25
- L.....29.25

If B. B. is omitted deduct \$6.00

No. 7356¹/₂

Die.....1.6 x 0.4 x 2.0..1.0
 B. Base.....2.0 x 0.10 x 0.10..1.5
 Weight complete 425 lbs.; no B. B. 170 lbs.

- C.....\$30.00
- D.....27.75
- F.....26.75
- G.....26.25
- H.....25.75
- I.....25.25
- K.....24.50
- L.....23.75

If B. B. is omitted deduct \$5.10

No. 7358¹/₄

Die.....1.6 x 0.4 x 2.0..1.0
 B. Base.....2.0 x 0.10 x 0.10..1.5
 Weight complete 425 lbs.; no B. B. 170 lbs.

- C.....\$38.25
- D.....36.00
- F.....35.00
- G.....34.50
- H.....34.00
- I.....33.50
- K.....32.75
- L.....32.00

If B. B. is omitted deduct \$5.10

No. 7359

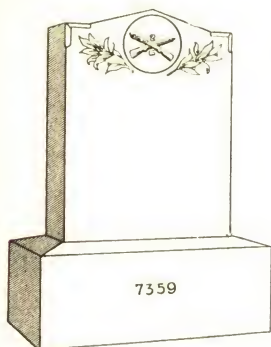

Die.....1.6 x 0.6 x 2. 0..1.6
 B. Base.....2.0 x 1.0 x 0.10..1.8

Weight complete 550 lbs.; no B. B. 250 lbs.

C.....	\$45.50
D.....	42.50
F.....	40.50
G.....	39.75
H.....	39.00
I.....	38.25
K.....	37.00
L.....	36.00

If B. B. is omitted deduct \$6.00

No. 7360

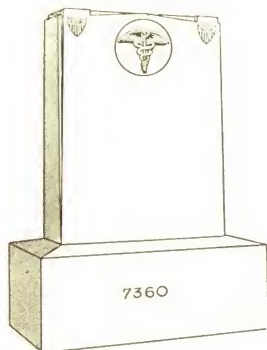

Die.....1.6 x 0.6 x 2. 0..1.6
 B. Base.....2.0 x 1.0 x 0.10..1.8

Weight complete 550 lbs.; no B. B. 250 lbs.

C.....	\$45.50
D.....	42.50
F.....	40.50
G.....	39.75
H.....	39.00
I.....	38.25
K.....	37.00
L.....	36.00

If B. B. is omitted deduct \$6.00

No. 7359¹/₄

Die.....1.6 x 0. 4 x 2. 0..1.0
 B. Base....2.0 x 0.10 x 0.10..1.5

Weight complete 425 lbs.; no B. B. 170 lbs.

C.....	\$39.25
D.....	37.00
F.....	36.00
G.....	35.50
H.....	35.00
I.....	34.50
K.....	33.75
L.....	33.00

If B. B. is omitted deduct \$5.10

No. 7360¹/₄

Die.....1.6 x 0. 4 x 2. 0..1.0
 B. Base....2.0 x 0.10 x 0.10..1.5

Weight complete 425 lbs.; no B. B. 170 lbs.

C.....	\$39.25
D.....	37.00
F.....	36.00
G.....	35.50
H.....	35.00
I.....	34.50
K.....	33.75
L.....	33.00

If B. B. is omitted deduct \$5.10

No. 7361

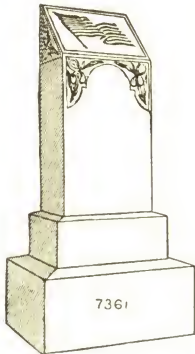

Die.....1.4 x 0.10 x 3.0 . . .3.4
 Base.....1.8 x 1.2 x 0.8 . . .1.4
 B. Base.....2.2 x 1.8 x 1.0 . . .3.7
 Weight complete 1400 lbs.; no B. B. 755 lbs.

- C.....\$89.50
- D.....79.00
- F.....74.00
- G.....72.00
- H.....69.50
- I.....66.50
- K.....63.00
- L.....60.00

If B. B. is omitted deduct \$12.55

No. 7362

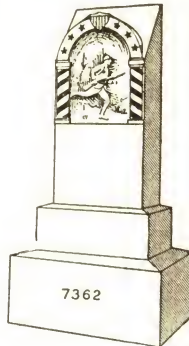

Die.....1.4 x 0.10 x 3.0 . . .3.4
 Base.....1.8 x 1.2 x 0.8 . . .1.4
 B. Base.....2.2 x 1.8 x 1.0 . . .3.7
 Weight complete 1400 lbs.; no B. B. 755 lbs.

- C.....\$125.00
- D.....114.00
- F.....110.00
- G.....107.00
- H.....105.00
- I.....103.00
- K.....99.00
- L.....95.50

If B. B. is omitted deduct \$12.55

No. 7361¹/₄

Die.....1.2 x 0.8 x 2.8 . . .2.1
 Base.....1.6 x 1.0 x 0.8 . . .1.0
 B. Base.....1.10 x 1.4 x 1.0 . . .2.5
 Weight complete 950 lbs.; no B. B. 515 lbs.

- C.....\$64.00
- D.....57.00
- F.....54.00
- G.....52.50
- H.....51.00
- I.....49.25
- K.....47.00
- L.....44.75

If B. B. is omitted deduct \$8.70

No. 7362¹/₄

Die.....1.2 x 0.8 x 2.8 . . .2.1
 Base.....1.6 x 1.0 x 0.8 . . .1.0
 B. Base.....1.10 x 1.4 x 1.0 . . .2.5
 Weight complete 950 lbs.; no B. B. 515 lbs.

- C.....\$100.00
- D.....93.00
- F.....90.00
- G.....88.50
- H.....87.00
- I.....85.50
- K.....83.00
- L.....80.50

If B. B. is omitted deduct \$8.70

No. 7361¹/₂

Die.....1.0 x 0.6 x 2.2 . . .1.1
 Base.....1.4 x 0.10 x 0.6 . . .0.7
 B. Base.....1.8 x 1.2 x 0.10 . . .1.7
 Weight complete 550 lbs.; no B. B. 265 lbs.

- C.....\$40.00
- D.....36.25
- F.....34.75
- G.....33.75
- H.....33.00
- I.....32.25
- K.....31.00
- L.....29.75

If B. B. is omitted deduct \$5.70

No. 7362¹/₂

Die.....1.2 x 0.6 x 2.6 . . .1.6
 Base.....1.6 x 0.10 x 0.6 . . .0.8
 B. Base.....1.10 x 1.2 x 0.10 . . .1.9
 Weight complete 675 lbs.; no B. B. 360 lbs.

- C.....\$82.00
- D.....77.00
- F.....75.00
- G.....74.00
- H.....73.00
- I.....71.50
- K.....70.00
- L.....68.50

If B. B. is omitted deduct \$6.30

No. 7364

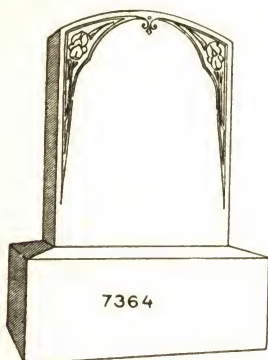

Die.....1.6 x 0.6 x 2. 0. .1.6
 B. Base.....2.0 x 1.0 x 0.10. .1.8
 Weight complete 550 lbs.; no B. B. 250 lbs.

C.....	\$38.25
D.....	34.25
F.....	33.25
G.....	32.50
H.....	31.75
I.....	31.00
K.....	29.75
L.....	28.75

If B. B. is omitted deduct \$6.00

No. 7364¹/₄

Die.....1.6 x 0. 4 x 2. 0. .1.0
 B. Base.....2.0 x 0.10 x 0.10. .1.5
 Weight complete 425 lbs.; no B. B. 170 lbs.

C.....	\$28.25
D.....	26.00
F.....	25.00
G.....	24.50
H.....	24.00
I.....	23.50
K.....	22.75
L.....	22.00

If B. B. is omitted deduct \$5.10

No. 7365

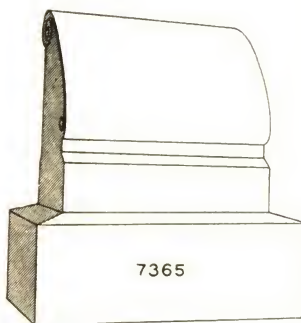

Die.....2.0 x 1.2 x 1.10. .4.3
 B. Base.....2.6 x 1.8 x 1. 0. .4.2
 Weight complete 1400 lbs.; no B. B. 650 lbs.

C.....	\$93.00
D.....	83.50
F.....	79.50
G.....	77.50
H.....	75.00
I.....	73.00
K.....	70.00
L.....	66.50

If B. B. is omitted deduct \$14.60

No. 7365¹/₄

Die.....2.0 x 1.0 x 1.10. .3.8
 B. Base.....2.6 x 1.6 x 1. 0. .3.9
 Weight complete 1250 lbs.; no B. B. 575 lbs.

C.....	\$82.00
D.....	74.00
F.....	70.00
G.....	68.50
H.....	66.50
I.....	64.50
K.....	62.00
L.....	59.00

If B. B. is omitted deduct \$13.15

No. 7365¹/₂

Die.....1.10 x 0.10 x 1. 8. .2.7
 B. Base.....2. 4 x 1. 4 x 0.10. .2.7
 Weight complete 900 lbs.; no B. B. 525 lbs.

C.....	\$62.50
D.....	57.00
F.....	54.00
G.....	53.00
H.....	51.50
I.....	50.50
K.....	48.50
L.....	46.50

If B. B. is omitted deduct \$9.30

No. 7368

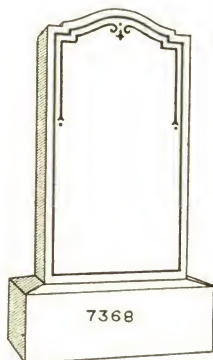

Die.....2.0 x 0.10 x 3.4..5.7
 B. Base.....2.8 x 1.6 x 1.2..4.8
 Weight complete 1800 lbs.; no B. B. 920 lbs.

C.....	\$106.00
D.....	93.50
F.....	87.50
G.....	85.00
H.....	82.00
I.....	79.50
K.....	75.00
L.....	71.00

If B. B. is omitted deduct \$16.35
 Face polished; balance sand finished

No. 7368¹/₄

Die.....1.8 x 0.8 x 3.0..3.4
 B. Base.....2.2 x 1.2 x 0.10..2.1
 Weight complete 950 lbs.; no B. B. 575 lbs.

C.....	\$65.50
D.....	58.00
F.....	55.00
G.....	53.00
H.....	51.50
I.....	49.75
K.....	47.25
L.....	44.75

If B. B. is omitted deduct \$7.50
 Face polished; balance sand finished

No. 7368¹/₂

Die.....1.8 x 0.6 x 3.0..2.6
 B. Base.....2.2 x 1.0 x 0.10..1.10
 Weight complete 750 lbs.; no B. B. 450 lbs.

C.....	\$51.50
D.....	46.00
F.....	43.50
G.....	42.25
H.....	41.00
I.....	39.75
K.....	38.00
L.....	36.00

If B. B. is omitted deduct \$6.60
 Face polished; balance sand finished

No. 7371

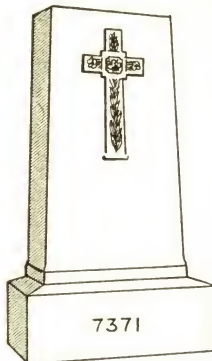

Die.....2.4 x 1.0 x 4.0..9.4
 B. Base.....3.2 x 1.10 x 1.0..5.10
 Weight complete 2500 lbs.; no B. B. 1450 lbs.

C.....	\$265.00
D.....	244.00
F.....	234.00
G.....	230.00
H.....	225.00
I.....	220.00
K.....	213.00
L.....	206.00

If B. B. is omitted deduct \$20.40

No. 7371¹/₄

Die.....2.0 x 0.10 x 3.6..5.10
 B. Base.....2.10 x 1.8 x 1.0..4.9
 Weight complete 1800 lbs.; no B. B. 950 lbs.

C.....	\$207.00
D.....	194.00
F.....	188.00
G.....	185.00
H.....	182.00
I.....	179.00
K.....	175.00
L.....	171.00

If B. B. is omitted deduct \$16.65

No. 7371¹/₂

Die.....2.0 x 0.8 x 3.6..4.8
 B. Base.....2.8 x 1.4 x 0.10..3.0
 Weight complete 1225 lbs.; no B. B. 685 lbs.

C.....	\$177.00
D.....	166.00
F.....	162.00
G.....	159.00
H.....	157.00
I.....	155.00
K.....	151.00
L.....	148.00

If B. B. is omitted deduct \$10.80

No. 7372

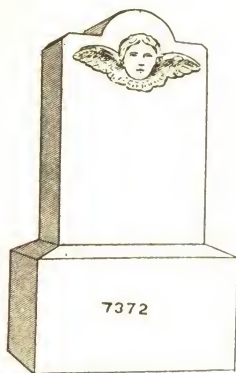

Die.....1.0 x 0.7 x 1.6..0.11
 B. Base....1.4 x 0.10 x 0.10..0.11

Weight complete 300 lbs.; no B. B. 135 lbs.

C.....	\$51.50
D.....	49.25
F.....	48.25
G.....	47.75
H.....	47.25
I.....	47.00
K.....	46.25
L.....	45.50

If B. B. is omitted deduct \$3.45

No. 7373

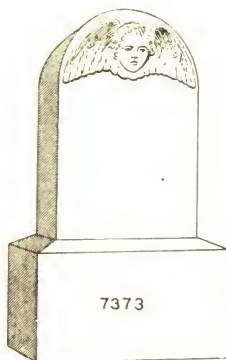

Die.....1.0 x 0.7 x 1.6..0.11
 B. Base....1.4 x 0.10 x 0.10..0.11

Weight complete 300 lbs.; no B. B. 135 lbs.

C.....	\$51.50
D.....	49.25
F.....	48.25
G.....	47.75
H.....	47.25
I.....	47.00
K.....	46.25
L.....	45.50

If B. B. is omitted deduct \$3.45

No. 7372¹/₄

Die.....1.0 x 0.6 x 1.6..0.9
 B. Base....1.4 x 0.9 x 0.8..0.8

Weight complete 230 lbs.; no B. B. 110 lbs.

C.....	\$45.00
D.....	43.50
F.....	42.50
G.....	42.25
H.....	41.75
I.....	41.50
K.....	41.00
L.....	40.25

If B. B. is omitted deduct \$2.50

No. 7373¹/₄

Die.....1.0 x 0.6 x 1.6..0.9
 B. Base....1.4 x 0.9 x 0.8..0.8

Weight complete 230 lbs.; no B. B. 110 lbs.

C.....	\$45.00
D.....	43.50
F.....	42.50
G.....	42.25
H.....	41.75
I.....	41.50
K.....	41.00
L.....	40.25

If B. B. is omitted deduct \$2.50

No. 7374

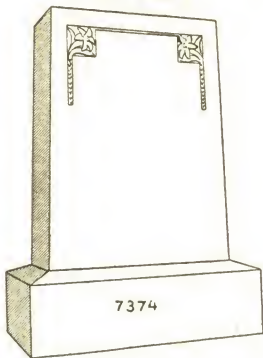

Die.....2.6 x 1.0 x 3.2 . 7. 11
 B. Ba. (S.S.) .3.4 x 1.8 x 1.0 . 5. 7
 Weight complete 2300 lbs.
 D.....\$152.00
 F.....144.00
 G.....140.00
 H.....136.00
 I.....132.00
 K.....126.00
 L.....120.00
 "M. M." finish

No. 7374¹/₄

Die.....2.4 x 0.10 x 3.0 . 5.10
 B. Ba. (S.S.) .3.2 x 1. 6 x 1.0 . 4. 9
 Weight complete 1800 lbs.
 D.....\$122.00
 F.....116.00
 G.....113.00
 H.....110.00
 I.....107.00
 K.....103.00
 L.....98.50
 "M. M." finish

No. 7374¹/₂

Die.....2.0 x 0.8 x 2.8 . 3.7
 B. Ba. (S.S.) .2.8 x 1.2 x 1.0 . 3.1
 Weight complete 1125 lbs.
 D.....\$84.00
 F.....80.50
 G.....79.00
 H.....77.00
 I.....75.00
 K.....72.50
 L.....70.00
 "M. M." finish

No. 7374³/₄

Die.....1.10 x 0. 6 x 2. 6 . 2.4
 B. Ba. (S.S.) 2. 4 x 0.10 x 0.10 . 1.7
 Weight complete 675 lbs.
 D.....\$60.50
 F.....58.00
 G.....57.00
 H.....56.00
 I.....55.00
 K.....53.00
 L.....51.50
 "M. M." finish

No. 7376

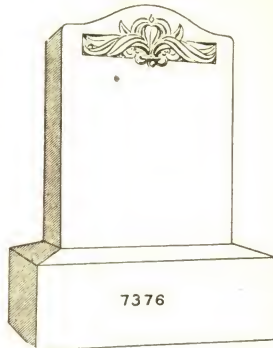

Die.....1.6 x 0.6 x 2. 0 . 1.6
 B. Base.....2.0 x 1.0 x 0.10 . 1.8
 Weight complete 550 lbs.; no B. B. 250 lbs.

C.....\$47.00
 D.....43.50
 F.....42.00
 G.....41.25
 H.....40.50
 I.....39.75
 K.....38.50
 L.....37.50

If B. B. is omitted deduct \$6.00

No. 7376¹/₄

Die.....1.6 x 0. 4 x 2. 0 . 1.0
 B. Base.....2.0 x 0.10 x 0.10 . 1.5
 Weight complete 425 lbs.; no B. B. 170 lbs.

C.....\$38.25
 D.....36.00
 F.....35.00
 G.....34.50
 H.....34.00
 I.....33.50
 K.....32.75
 L.....32.00

If B. B. is omitted deduct \$5.10

No. 7380



Die..... 1.10 x 0.10 x 4. 0. 6.1
 B. Base... 3. 2 x 1. 8 x 0.10. .4.5
 Weight complete 1650 lbs.; no B. B. 850 lbs.

C.....	\$235.00
D.....	218.00
F.....	212.00
G.....	209.00
H.....	206.00
I.....	203.00
K.....	198.00
L.....	194.00

If B. B. is omitted deduct \$15.45
 Sand finished

No. 7380¹/₄

Die..... 1.10 x 0.8 x 4. 0. 4.11
 B. Base... 3. 0 x 1.4 x 0.10. .3. 4
 Weight complete 1300 lbs.; no B. B. 700 lbs.

C.....	\$206.00
D.....	194.00
F.....	190.00
G.....	187.00
H.....	185.00
I.....	182.00
K.....	178.00
L.....	175.00

If B. B. is omitted deduct \$11.65
 Sand finished

No. 7384³/₄

Die..... 1.8 x 0.6 x 2. 4. 1.11
 B. Base... 2.2 x 1.0 x 0.10. .1.10
 Weight complete 675 lbs.; no B. B. 345 lbs.

D.....	\$46.75
F.....	44.75
G.....	43.75
H.....	42.75
I.....	42.00
K.....	40.50
L.....	39.00

If B. B. is omitted deduct \$6.60
 Face only polished; balance sand finished

No. 7383

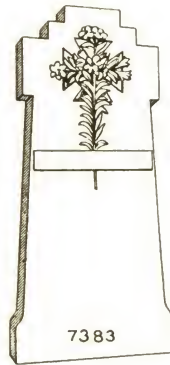

Die..... 2.6 x 1.0 x 6.0. .15.0
 Weight complete 2400 lbs.

C.....	\$367.00
D.....	334.00
F.....	319.00
G.....	311.00
H.....	304.00
I.....	296.00
K.....	285.00
L.....	274.00

No. 7383¹/₄

Die..... 2.6 x 0.10 x 6.0. .12.6
 Weight complete 2050 lbs.

C.....	\$331.00
D.....	303.00
F.....	291.00
G.....	285.00
H.....	278.00
I.....	272.00
K.....	263.00
L.....	253.00

No. 7383¹/₂

Die..... 2.6 x 0.8 x 6.0. .10.0
 Weight complete 1650 lbs.

C.....	\$296.00
D.....	273.00
F.....	263.00
G.....	258.00
H.....	253.00
I.....	248.00
K.....	241.00
L.....	233.00

No. 7384

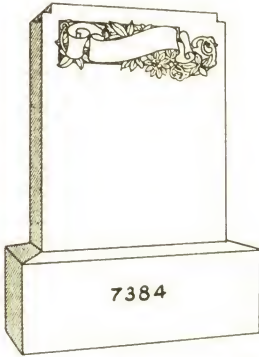

Die.....2.0 x 1.0 x 2.6 .5 0
 B. Base.....2.6 x 1.6 x 1.0 .3.9
 Weight complete 1575 lbs.; no B. B. 900 lbs.
 D.....\$92.00
 F.....87.00
 G.....84.50
 H.....82.00
 I.....79.50
 K.....76.00
 L.....72.00
 If B. B. is omitted deduct \$13.15
 Face only polished; balance sand finished

No. 7384¹/₄

Die.....2.0 x 0.10 x 2.6 .4.2
 B. Base.....2.6 x 1.4 x 1.0 .3.4
 Weight complete 1350 lbs.; no B. B. 750 lbs.
 D.....\$80.00
 F.....76.00
 G.....74.00
 H.....72.00
 I.....69.50
 K.....66.50
 L.....63.50
 If B. B. is omitted deduct \$11.65
 Face only polished; balance sand finished

No. 7384¹/₂

Die.....2.0 x 0.8 x 2.6 .3.4
 B. Base.....2.6 x 1.2 x 1.0 .2.11
 Weight complete 1100 lbs.; no B. B. 575 lbs.
 D.....\$68.50
 F.....65.50
 G.....63.50
 H.....62.00
 I.....60.50
 K.....58.00
 L.....55.00
 If B. B. is omitted deduct \$10.50
 Face only polished; balance sand finished

No. 7384³/₄

See previous page

No. 7385

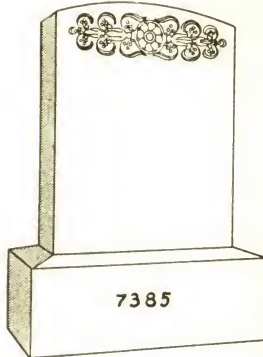

Die.....2.0 x 1.0 x 2.6 .5 0
 B. Base.....2.6 x 1.6 x 1.0 .3.9
 Weight complete 1575 lbs.; no B. B. 900 lbs.
 G.....\$85.00
 H.....82.50
 I.....80.00
 K.....76.50
 L.....72.50
 If B. B. is omitted deduct \$13.15
 Face only polished; balance sand finished

No. 7385¹/₄

Die.....2.0 x 0.10 x 2.6 .4.2
 B. Base.....2.6 x 1.4 x 1.0 .3.4
 Weight complete 1350 lbs.; no B. B. 750 lbs.
 G.....\$73.50
 H.....71.50
 I.....69.00
 K.....66.00
 L.....63.00
 If B. B. is omitted deduct \$11.65
 Face only polished; balance sand finished

No. 7385¹/₂

Die.....2.0 x 0.8 x 2.6 .3.4
 B. Base.....2.6 x 1.2 x 1.0 .2.11
 Weight complete 1100 lbs.; no B. B. 575 lbs.
 G.....\$62.50
 H.....61.00
 I.....59.50
 K.....57.00
 L.....54.00
 If B. B. is omitted deduct \$10.50
 Face only polished; balance sand finished

No. 7385³/₄

Die.....1.8 x 0.6 x 2.4 .1.11
 B. Base.....2.2 x 1.0 x 0.10 .1.10
 Weight complete 675 lbs.; no B. B. 345 lbs.
 G.....\$41.75
 H.....40.75
 I.....40.00
 K.....38.50
 L.....37.00
 If B. B. is omitted deduct \$6.60
 Face only polished; balance sand finished

No. 7386

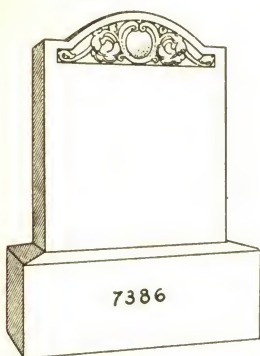

Die.....2.0 x 1.0 x 2.6...5.0
 B. Base.....2.6 x 1.6 x 1.0...3.9
 Weight complete 1575 lbs.; no B. B. 900 lbs.
 G.....\$85.00
 H.....82.50
 I.....80.00
 K.....76.50
 L.....72.50
 If B. B. is omitted deduct \$13.15
 Face only polished; balance sand finished

No. 7386¹/₄

Die.....2.0 x 0.10 x 2.6...4.2
 B. Base.....2.6 x 1.4 x 1.0...3.4
 Weight complete 1350 lbs.; no B. B. 750 lbs.
 G.....\$73.50
 H.....71.50
 I.....69.00
 K.....66.00
 L.....63.00
 If B. B. is omitted deduct \$11.65
 Face only polished; balance sand finished

No. 7386¹/₂

Die.....2.0 x 0.8 x 2.6...3.4
 B. Base.....2.6 x 1.2 x 1.0...2.11
 Weight complete 1100 lbs.; no B. B. 575 lbs.
 G.....\$62.50
 H.....61.00
 I.....59.50
 K.....57.00
 L.....54.00
 If B. B. is omitted deduct \$10.50
 Face only polished; balance sand finished

No. 7386³/₄

Die.....1.8 x 0.6 x 2.4...1.11
 B. Base.....2.2 x 1.0 x 0.10...1.10
 Weight complete 675 lbs.; no B. B. 345 lbs.
 G.....\$41.75
 H.....40.75
 I.....40.00
 K.....38.50
 L.....37.00
 If B. B. is omitted deduct \$6.60
 Face only polished; balance sand finished

No. 7387

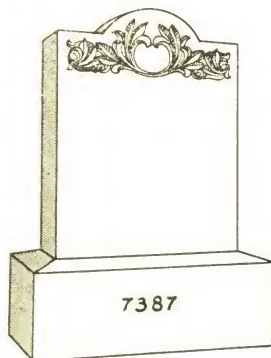

Die.....2.0 x 1.0 x 2.6...5.0
 B. Base.....2.6 x 1.6 x 1.0...3.9
 Weight complete 1575 lbs.; no B. B. 900 lbs.
 G.....\$77.50
 H.....75.00
 I.....72.50
 K.....69.00
 L.....65.00
 If B. B. is omitted deduct \$13.15
 Face only polished; balance sand finished

No. 7387¹/₄

Die.....2.0 x 0.10 x 2.6...4.2
 B. Base.....2.6 x 1.4 x 1.0...3.4
 Weight complete 1350 lbs.; no B. B. 750 lbs.
 G.....\$66.50
 H.....64.50
 I.....62.00
 K.....59.00
 L.....56.00
 If B. B. is omitted deduct \$11.65
 Face only polished; balance sand finished

No. 7387¹/₂

Die.....2.0 x 0.8 x 2.6...3.4
 B. Base.....2.6 x 1.2 x 1.0...2.11
 Weight complete 1100 lbs.; no B. B. 575 lbs.
 G.....\$55.00
 H.....53.50
 I.....52.00
 K.....49.25
 L.....46.50
 If B. B. is omitted deduct \$10.50
 Face only polished; balance sand finished

No. 7387³/₄

Die.....1.8 x 0.6 x 2.4...1.11
 B. Base.....2.2 x 1.0 x 0.10...1.10
 Weight complete 675 lbs.; no B. B. 345 lbs.
 G.....\$36.25
 H.....35.25
 I.....34.50
 K.....33.00
 L.....31.50
 If B. B. is omitted deduct \$6.60
 Face only polished; balance sand finished

No. 7388

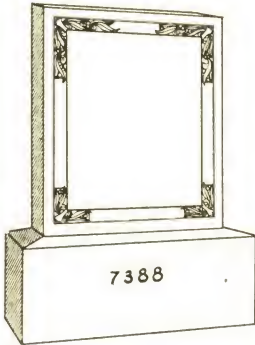

Die.....2.0 x 1.0 x 2.6..5.0
 B. Base.....2.6 x 1.6 x 1.0..3.9
 Weight complete 1575 lbs.; no B. B. 900 lbs.
 G.....\$86.50
 H.....84.00
 I.....81.50
 K.....78.00
 L.....74.00
 If B. B. is omitted deduct \$13.15
 Top and face polished; balance sand finished.

No. 7388¹/₄

Die.....2.0 x 0.10 x 2.6..4.2
 B. Base.....2.6 x 1.4 x 1.0..3.4
 Weight complete 1350 lbs.; no B. B. 750 lbs.
 G.....\$76.50
 H.....74.50
 I.....72.00
 K.....69.00
 L.....66.00
 If B. B. is omitted deduct \$11.65
 Top and face polished; balance sand finished.

No. 7388¹/₂

Die.....2.0 x 0.8 x 2.6..3.4
 B. Base.....2.6 x 1.2 x 1.0..2.11
 Weight complete 1100 lbs.; no B. B. 575 lbs.
 G.....\$66.50
 H.....65.00
 I.....63.50
 K.....61.00
 L.....58.00
 If B. B. is omitted deduct \$10.50
 Top and face polished; balance sand finished.

No. 7388³/₄

Die.....1.8 x 0.6 x 2.4..1.11
 B. Base.....2.2 x 1.0 x 0.10..1.10
 Weight complete 675 lbs.; no B. B. 345 lbs.
 G.....\$46.75
 H.....45.75
 I.....45.00
 K.....43.50
 L.....42.00
 If B. B. is omitted deduct \$6.60
 Top and face polished; balance sand finished.

No. 7389

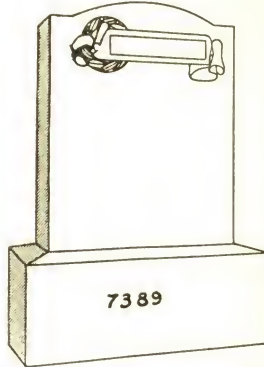

Die.....2.0 x 1.0 x 2.6..5.0
 B. Base.....2.6 x 1.6 x 1.0..3.9
 Weight complete 1575 lbs.; no B. B. 900 lbs.
 G.....\$88.00
 H.....85.50
 I.....83.00
 K.....79.00
 L.....75.50
 If B. B. is omitted deduct \$13.15
 Face only polished; balance sand finished

No. 7389¹/₄

Die.....2.0 x 0.10 x 2.6..4.2
 B. Base.....2.6 x 1.4 x 1.0..3.4
 Weight complete 1350 lbs.; no B. B. 750 lbs.
 G.....\$76.50
 H.....74.50
 I.....72.00
 K.....69.00
 L.....66.00
 If B. B. is omitted deduct \$11.65
 Face only polished; balance sand finished

No. 7389¹/₂

Die.....2.0 x 0.8 x 2.6..3.4
 B. Base.....2.6 x 1.2 x 1.0..2.11
 Weight complete 1100 lbs.; no B. B. 575 lbs.
 G.....\$65.50
 H.....64.00
 I.....62.50
 K.....60.00
 L.....57.00
 If B. B. is omitted deduct \$10.50
 Face only polished; balance sand finished

No. 7389³/₄

Die.....1.8 x 0.6 x 2.4..1.11
 B. Base.....2.2 x 1.0 x 0.10..1.10
 Weight complete 675 lbs.; no B. B. 345 lbs.
 G.....\$44.75
 H.....43.75
 I.....43.00
 K.....41.50
 L.....40.00
 If B. B. is omitted deduct \$6.60
 Face only polished; balance sand finished

No. 7390

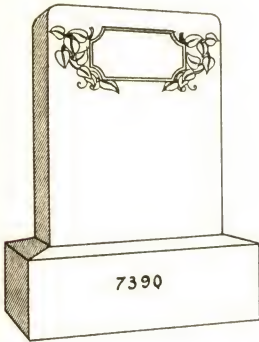

Die.....2.0 x 1.0 x 2.6..5.0
 B. Base.....2.6 x 1.6 x 1.0..3.9
 Weight complete 1575 lbs.; no B. B. 900 lbs.
 G.....\$74.50
 H.....72.00
 I.....69.50
 K.....66.00
 L.....62.00
 If B. B. is omitted deduct \$13.15
 Face only polished; balance sand finished

No. 7390¹/₄

Die.....2.0 x 0.10 x 2.6..4.2
 B. Base.....2.6 x 1.4 x 1.0..3.4
 Weight complete 1350 lbs.; no B. B. 750 lbs.
 G.....\$64.00
 H.....62.00
 I.....59.50
 K.....56.50
 L.....53.50
 If B. B. is omitted deduct \$11.65
 Face only polished; balance sand finished

No. 7390¹/₂

Die.....2.0 x 0.8 x 2.6..3.4
 B. Base.....2.6 x 1.2 x 1.0..2.11
 Weight complete 1100 lbs.; no B. B. 575 lbs.
 G.....\$53.50
 H.....52.00
 I.....50.50
 K.....47.75
 L.....45.00
 If B. B. is omitted deduct \$10.50
 Face only polished; balance sand finished

No. 7390³/₄

Die.....1.8 x 0.6 x 2.4..1.11
 B. Base.....2.2 x 1.0 x 0.10..1.10
 Weight complete 675 lbs.; no B. B. 345 lbs.
 G.....\$34.00
 H.....33.00
 I.....32.25
 K.....30.75
 L.....29.25
 If B. B. is omitted deduct \$6.60
 Face only polished; balance sand finished

No. 7391

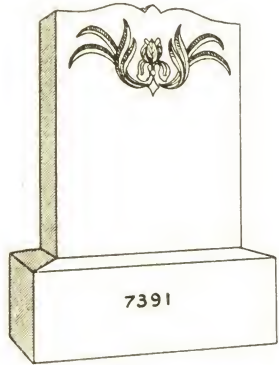

Die.....2.0 x 1.0 x 2.6..5.0
 B. Base.....2.6 x 1.6 x 1.0..3.9
 Weight complete 1575 lbs.; no B. B. 900 lbs.
 G.....\$77.50
 H.....75.00
 I.....72.50
 K.....69.00
 L.....65.00
 If B. B. is omitted deduct \$13.15
 Face only polished; balance sand finished

No. 7391¹/₄

Die.....2.0 x 0.10 x 2.6..4.2
 B. Base.....2.6 x 1.4 x 1.0..3.4
 Weight complete 1350 lbs.; no B. B. 750 lbs.
 G.....\$66.50
 H.....64.50
 I.....62.00
 K.....59.00
 L.....56.00
 If B. B. is omitted deduct \$11.65
 Face only polished; balance sand finished

No. 7391¹/₂

Die.....2.0 x 0.8 x 2.6..3.4
 B. Base.....2.6 x 1.2 x 1.0..2.11
 Weight complete 1100 lbs.; no B. B. 575 lbs.
 G.....\$55.00
 H.....53.50
 I.....52.00
 K.....49.25
 L.....46.50
 If B. B. is omitted deduct \$10.50
 Face only polished; balance sand finished

No. 7391³/₄

Die.....1.8 x 0.6 x 2.4..1.11
 B. Base.....2.2 x 1.0 x 0.10..1.10
 Weight complete 675 lbs.; no B. B. 345 lbs.
 G.....\$36.25
 H.....35.25
 I.....34.50
 K.....33.00
 L.....31.50
 If B. B. is omitted deduct \$6.60
 Face only polished; balance sand finished

No. 7392

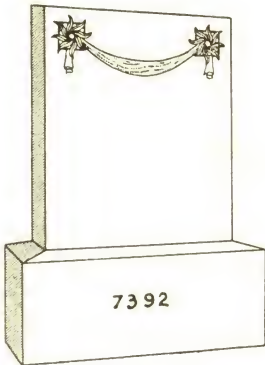

Die.....2.0 x 1.0 x 2.6 .5.0
 B. Base.....2.6 x 1.6 x 1.0 .3.9
 Weight complete 1575 lbs.; no B. B. 900 lbs.
 G.....\$84.50
 H.....82.00
 I.....79.50
 K.....76.00
 L.....72.00
 If B. B. is omitted deduct \$13.15
 Top and face polished; balance sand finished.

No. 7392¹/₄

Die.....2.0 x 0.10 x 2.6 .4.2
 B. Base.....2.6 x 1.4 x 1.0 .3.4
 Weight complete 1350 lbs.; no B. B. 750 lbs.
 G.....\$74.00
 H.....72.00
 I.....69.50
 K.....66.50
 L.....63.50
 If B. B. is omitted deduct \$11.65
 Top and face polished; balance sand finished.

No. 7392¹/₂

Die.....2.0 x 0.8 x 2.6 .3.4
 B. Base.....2.6 x 1.2 x 1.0 .2.11
 Weight complete 1100 lbs.; no B. B. 575 lbs.
 G.....\$63.50
 H.....62.00
 I.....60.50
 K.....58.00
 L.....55.00
 If B. B. is omitted deduct \$10.50
 Top and face polished; balance sand finished.

No. 7392³/₄

Die.....1.8 x 0.6 x 2.4 .1.11
 B. Base.....2.2 x 1.0 x 0.10 .1.10
 Weight complete 675 lbs.; no B. B. 345 lbs.
 G.....\$43.75
 H.....42.75
 I.....42.00
 K.....40.50
 L.....39.00
 If B. B. is omitted deduct \$6.60
 Top and face polished, balance sand finished.

No. 7393

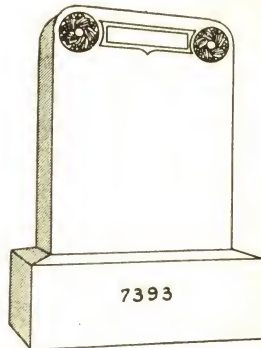

Die.....2.0 x 1.0 x 2.6 .5.0
 B. Base.....2.6 x 1.6 x 1.0 .3.9
 Weight complete 1575 lbs.; no B. B. 900 lbs.
 G.....\$84.50
 H.....82.00
 I.....79.50
 K.....76.00
 L.....72.00
 If P. B. is omitted deduct \$13.15
 Face only polished; balance sand finished.

No. 7393¹/₄

Die.....2.0 x 0.10 x 2.6 .4.2
 B. Base.....2.6 x 1.4 x 1.0 .3.4
 Weight complete 1350 lbs.; no B. B. 750 lbs.
 G.....\$74.00
 H.....72.00
 I.....69.50
 K.....66.50
 L.....63.50
 If B. B. is omitted deduct \$11.65
 Face only polished; balance sand finished.

No. 7393¹/₂

Die.....2.0 x 0.8 x 2.6 .3.4
 B. Base.....2.6 x 1.2 x 1.0 .2.11
 Weight complete 1100 lbs.; no B. B. 575 lbs.
 G.....\$63.50
 H.....62.00
 I.....60.50
 K.....58.00
 L.....55.00
 If B. B. is omitted deduct \$10.50
 Face only polished; balance sand finished.

No. 7393³/₄

Die.....1.8 x 0.6 x 2.4 .1.11
 B. Base.....2.2 x 1.0 x 0.10 .1.10
 Weight complete 675 lbs.; no B. B. 345 lbs.
 G.....\$43.75
 H.....42.75
 I.....42.00
 K.....40.50
 L.....39.00
 If B. B. is omitted deduct \$6.60
 Face only polished; balance sand finished.

No. 7394

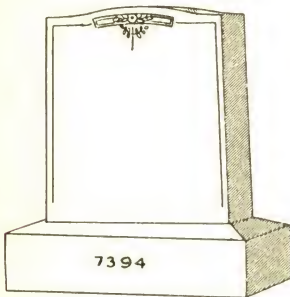

Die.....2.6 x 0.10 x 2.10 .5.11
 B.Ba. (S.S.) .3.0 x 1. 4 x 1. 0 .4. 0
 Weight complete 1700 lbs.

D.....	\$111.00
F.....	105.00
G.....	102.00
H.....	99.00
I.....	96.00
K.....	91.50
L.....	87.50

"M. M." finish

No. 7395

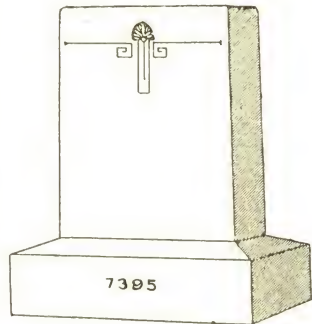

Die.....2.4 x 0.10 x 3.0 .5.10
 B.Ba. (S.S.) .3.2 x 1. 6 x 1.0 .4. 9
 Weight complete 1900 lbs.

D.....	\$106.00
F.....	99.50
G.....	96.50
H.....	94.00
I.....	91.00
K.....	86.50
L.....	82.00

"M. M." finish

No. 7394¹/₄

Die.....2.2 x 0.8 x 2. 6 .3.7
 B. Ba. (S.S.) .2.8 x 1.2 x 0.10 .2.7
 Weight complete 1075 lbs.

D.....	\$77.50
F.....	73.50
G.....	72.00
H.....	70.00
I.....	68.50
K.....	65.50
L.....	63.00

"M. M." finish

No. 7395¹/₄

Die.....2. 0 x 0.8 x 2.6 .3.4
 B. Ba. (S.S.) .2.10 x 1.4 x 1.0 .3.9
 Weight complete 1275 lbs.

D.....	\$71.50
F.....	68.50
G.....	66.50
H.....	65.00
I.....	63.50
K.....	61.00
L.....	58.50

"M. M." finish

No. 7394¹/₂

Die.....1.10 x 0.6 x 2. 2 .2. 0
 B.Ba. (S.S.) .2. 4 x 1.0 x 0.10 .1.11
 Weight complete 675 lbs.

D.....	\$53.00
F.....	51.00
G.....	50.00
H.....	49.00
I.....	48.00
K.....	46.50
L.....	45.00

"M. M." finish

No. 7395¹/₂

Die.....1.8 x 0.6 x 2. 4 .1 11
 B.Ba. (S.S.) .2.4 x 1.0 x 0.10 .1.11
 Weight complete 690 lbs.

D.....	\$46.25
F.....	44.25
G.....	43.25
H.....	42.25
I.....	41.50
K.....	40.00
L.....	38.50

"M. M." finish

No. 7396

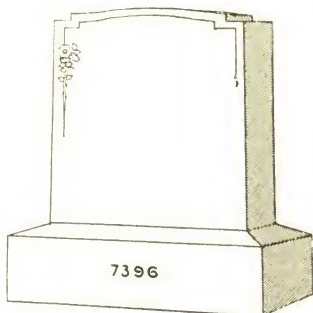

Die.....2.6 x 0.10 x 2.10 .5.11
 B.Ba. (S.S.) .3.0 x 1.4 x 1.0 .4.0
 Weight complete 1700 lbs.

D.....	\$118.00
F.....	112.00
G.....	109.00
H.....	106.00
I.....	103.00
K.....	98.50
L.....	94.50

"M. M." finish

No. 7397

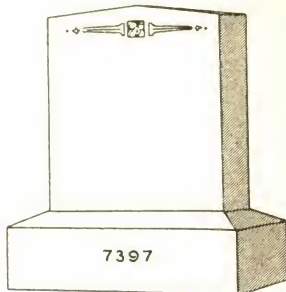

Die.....2.4 x 0.10 x 2.8 .5.2
 B.Ba. (S.S.) .2.10 x 1.4 x 1.0 .3.9
 Weight complete 1575 lbs.

D.....	\$92.50
F.....	87.50
G.....	85.00
H.....	82.50
I.....	79.50
K.....	76.00
L.....	72.00

"M. M." finish

No. 7396¹/₄

Die.....2.2 x 0.8 x 2.6 .3.7
 B. Ba. (S.S.) .2.8 x 1.2 x 0.10 .2.7
 Weight complete 1075 lbs.

D.....	\$84.00
F.....	80.00
G.....	78.50
H.....	76.50
I.....	75.00
K.....	72.00
L.....	69.50

"M. M." finish

No. 7397¹/₄

Die.....2.0 x 0.8 x 2.6 .3.4
 B. Ba. (S.S.) .2.6 x 1.2 x 1.0 .2.11
 Weight complete 1100 lbs.

D.....	\$66.50
F.....	63.50
G.....	61.50
H.....	60.00
I.....	58.50
K.....	55.75
L.....	53.25

"M. M." finish

No. 7396¹/₂

Die.....1.10 x 0.6 x 2.2 .2.0
 B.Ba. (S.S.) .2.4 x 1.0 x 0.10 .1.11
 Weight complete 675 lbs.

D.....	\$59.50
F.....	57.50
G.....	56.50
H.....	55.50
I.....	54.50
K.....	53.00
L.....	51.50

"M. M." finish

No. 7397¹/₂

Die.....1.8 x 0.6 x 2.4 .1.11
 B.Ba. (S.S.) .2.2 x 1.0 x 0.10 .1.10
 Weight complete 650 lbs.

D.....	\$43.00
F.....	41.00
G.....	40.00
H.....	39.00
I.....	38.25
K.....	36.75
L.....	35.25

"M. M." finish

No. 7398

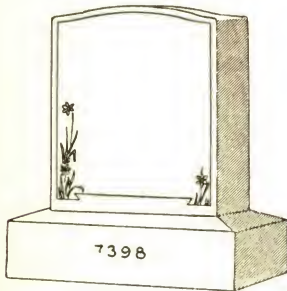

Die.....2. 4 x 0.10 x 2.8..5.2
 B.Ba. (S.S.) .2.10 x 1. 4 x 1.0..3.9
 Weight complete 1575 lbs.

D.....	\$92.50
F.....	87.50
G.....	85.00
H.....	82.50
I.....	79.50
K.....	76.00
L.....	72.00

"M. M." finish

No. 7398¹/₄

Die.....2.0 x 0.8 x 2.6..3. 4
 B. Ba. (S.S.) .2.6 x 1.2 x 1.0..2.11
 Weight complete 1100 lbs.

D.....	\$66.50
F.....	63.50
G.....	61.50
H.....	60.00
I.....	58.50
K.....	55.75
L.....	53.25

"M. M." finish

No. 7398¹/₂

Die.....1.8 x 0.6 x 2. 4..1.11
 B.Ba. (S.S.) .2.2 x 1.0 x 0.10..1.10
 Weight complete 650 lbs.

D.....	\$43.00
F.....	41.00
G.....	40.00
H.....	39.00
I.....	38.25
K.....	36.75
L.....	35.25

"M. M." finish

No. 7399

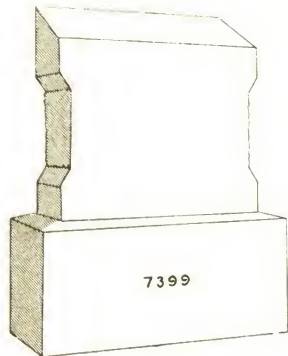

Die.....2.0 x 0.10 x 2.0..3.4
 B. Base.....2.6 x 1. 4 x 1.0..3.4
 Weight complete 1100 lbs.; no B. B. 500 lbs.

D.....	\$58.00
F.....	55.00
G.....	53.00
H.....	51.50
I.....	49.75
K.....	47.25
L.....	44.75

If B. B. is omitted deduct \$11.65

No. 7399¹/₄

Die.....1.8 x 0.8 x 1.8..1.10
 B. Base.....2.0 x 1.0 x 1.0..2. 0
 Weight complete 650 lbs.; no B. B. 290 lbs.

D.....	\$34.25
F.....	32.25
G.....	31.50
H.....	30.50
I.....	29.50
K.....	28.25
L.....	26.75

If B. B. is omitted deduct \$7.20

No. 7399¹/₂

Die.....1. 6 x 0. 6 x 1. 6..1.2
 B. Base....1.10 x 0.10 x 0.10..1.3
 Weight complete 410 lbs.; no B. B. 185 lbs.

D.....	\$22.75
F.....	21.75
G.....	21.00
H.....	20.50
I.....	20.00
K.....	19.00
L.....	18.25

If B. B. is omitted deduct \$4.50

No. 7400

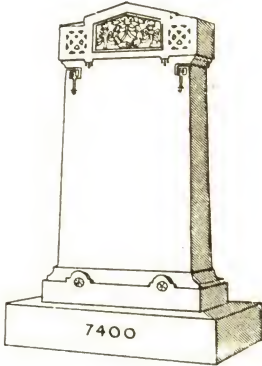

Die.....2.6 x 1. 0 x 4. 4. .10.10
 Base.....3.0 x 1. 2 x 0. 8. . 2. 4
 B.Ba. (S.S.) .4.0 x 1.10 x 0.10. . 6. 1

Weight complete 3000 lbs.

D.....\$328.00
 F..... 314.00
 G..... 308.00
 H..... 301.00
 I..... 295.00
 K..... 285.00
 L..... 275.00

No. 7401

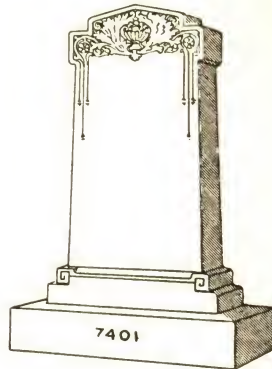

Die.....2.4 x 1. 0 x 4. 4. .10.1
 Base.....3.0 x 1. 2 x 0. 8. .2 .4
 B.Ba. (S.S.) .4.0 x 1.10 x 0.10. .6 .1

Weight complete 3000 lbs.

D.....\$329.00
 F..... 317.00
 G..... 311.00
 H..... 304.00
 I..... 298.00
 K..... 289.00
 L..... 280.00

No. 7400¹/₄

Die.....2.6 x 0.10 x 4. 4. .9.0
 Base.....3.0 x 1. 0 x 0. 8. .2.0
 B.Ba. (S.S.) .4.0 x 1. 8 x 0.10. .5.7

Weight complete 2650 lbs.

D.....\$294.00
 F..... 284.00
 G..... 278.00
 H..... 273.00
 I..... 267.00
 K..... 259.00
 L..... 251.00

No. 7401¹/₄

Die.....2.4 x 0.10 x 4. 4. .8.5
 Base.....3.0 x 1. 0 x 0. 8. .2.0
 B.Ba. (S.S.) .4.0 x 1. 8 x 0.10. .5.7

Weight complete 2600 lbs.

D.....\$296.00
 F..... 286.00
 G..... 281.00
 H..... 275.00
 I..... 270.00
 K..... 262.00
 L..... 255.00

No. 7400¹/₂

Die.....2.6 x 0. 8 x 4. 4. .7.3
 Base.....3.0 x 0.10 x 0. 8. .1.8
 B.Ba. (S.S.) .4.0 x 1. 6 x 0.10. .5.0

Weight complete 2300 lbs.

D.....\$260.00
 F..... 252.00
 G..... 247.00
 H..... 243.00
 I..... 238.00
 K..... 231.00
 L..... 225.00

No. 7401¹/₂

Die.....2.4 x 0. 8 x 4. 4. .6.9
 Base.....3.0 x 0.10 x 0. 8. .1.8
 B.Ba. (S.S.) .4.0 x 1. 6 x 0.10. .5.0

Weight complete 2200 lbs.

D.....\$263.00
 F..... 255.00
 G..... 251.00
 H..... 246.00
 I..... 242.00
 K..... 236.00
 L..... 230.00

No. 7402

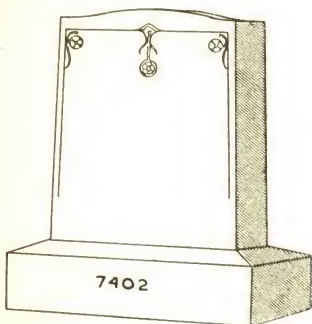

Die.....2.6 x 1. 0 x 3.0 .7.6
 B.Ba. (S.S.) .3.6 x 1.10 x 1.0 .6.5

Weight complete 2350 lbs.

D.....	\$160.00
F.....	151.00
G.....	149.00
H.....	145.00
I.....	141.00
K.....	135.00
L.....	130.00

"M. M." finish

No. 7402¹/₄

Die.....2.6 x 0.10 x 3.0 .6. 3
 B.Ba. (S.S.) .3.6 x 1. 8 x 1.0 .5.10

Weight complete 2050 lbs.

D.....	\$140.00
F.....	134.00
G.....	131.00
H.....	128.00
I.....	125.00
K.....	120.00
L.....	115.00

"M. M." finish

No. 7402¹/₂

Die.....2.6 x 0.8 x 3.0 .5.0
 B. Ba. (S.S.) .3.6 x 1.4 x 1.0 .4.8

Weight complete 1650 lbs.

D.....	\$115.00
F.....	111.00
G.....	108.00
H.....	106.00
I.....	103.00
K.....	99.50
L.....	95.50

"M. M." finish

No. 7403

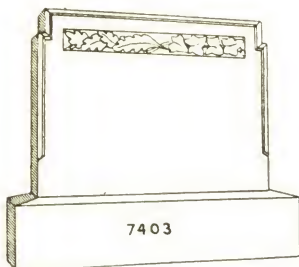

Die.....2.8 x 0.6 x 2. 0 .2.8
 B. Base.....3.2 x 1.0 x 0.10 .2.8

Weight complete 950 lbs.; no B. B. 470 lbs.

D.....	\$67.50
F.....	\$64.50
G.....	63.50
H.....	62.00
I.....	60.50
K.....	58.50
L.....	56.50

If B. B. is omitted deduct \$9.60

No. 7403¹/₄

Die.....2.8 x 0. 4 x 2. 0 .1.9
 B. Base.....3.2 x 0.10 x 0.10 .2.2

Weight complete 700 lbs.; no B. B. 310 lbs.

D.....	\$53.00
F.....	51.00
G.....	50.50
H.....	49.25
I.....	48.50
K.....	47.25
L.....	45.75

If B. B. is omitted deduct \$7.80

No. 7404

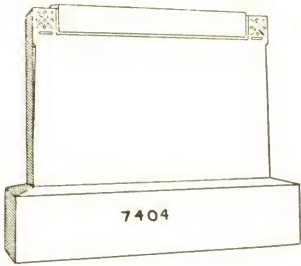

Die.....2.8 x 0.6 x 1.10..2.5
 B. Base.....3.2 x 1.0 x 0.10..2.8
 Weight complete 900 lbs.; no B. B. 420 lbs.

D.....	\$47.25
F.....	44.75
G.....	43.50
H.....	42.25
I.....	41.25
K.....	39.25
L.....	37.50

If B. B. is omitted deduct \$9.60

No. 7405

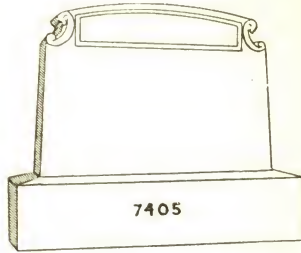

Die.....2.8 x 0.6 x 1.10..2.5
 B. Base.....3.2 x 1.0 x 0.10..2.8
 Weight complete 900 lbs.; no B. B. 420 lbs.

D.....	\$59.00
F.....	57.00
G.....	55.50
H.....	54.50
I.....	53.00
K.....	51.50
L.....	49.50

If B. B. is omitted deduct \$9.60

No. 7404¹/₄

Die.....2.8 x 0.4 x 1.10..1.8
 B. Base.....3.2 x 0.10 x 0.10..2.2
 Weight complete 675 lbs.; no B. B. 285 lbs.

D.....	\$34.75
F.....	33.25
G.....	32.25
H.....	31.50
I.....	30.75
K.....	29.50
L.....	28.25

If B. B. is omitted deduct \$7.80

No. 7405¹/₄

Die.....2.8 x 0.4 x 1.10..1.8
 B. Base.....3.2 x 0.10 x 0.10..2.2
 Weight complete 675 lbs.; no B. B. 285 lbs.

D.....	\$45.75
F.....	44.25
G.....	43.25
H.....	42.50
I.....	41.75
K.....	40.50
L.....	39.25

If B. B. is omitted deduct \$7.80

No. 7406

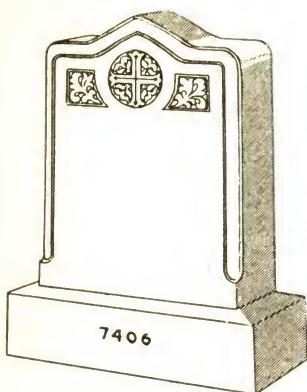

Die.....2.6 x 0.10 x 3.0 .6.3
 B. Base.....3.6 x 1.6 x 1.0 .5.3

Weight complete 1900 lbs.; no B. B. 955 lbs.

D.....	\$153.00
F.....	147.00
G.....	144.00
H.....	141.00
I.....	138.00
K.....	133.00
L.....	128.00

If B. B. is omitted deduct \$18.40
 Hone finished

No. 7406¹/₄

Die.....2.4 x 0.8 x 2.10 .4.5
 B. Base.....3.2 x 1.2 x 0.10 .3.1

Weight complete 1275 lbs.; no B. B. 720 lbs.

D.....	\$121.00
F.....	117.00
G.....	115.00
H.....	112.00
I.....	110.00
K.....	107.00
L.....	104.00

If B. B. is omitted deduct \$10.80
 Hone finished

No. 7406¹/₂

Die.....2.0 x 0.6 x 2.6 .2.6
 B. Base.....2.10 x 1.0 x 0.10 .2.4

Weight complete 825 lbs.; no B. B. 405 lbs.

D.....	\$96.00
F.....	94.00
G.....	92.50
H.....	91.50
I.....	90.00
K.....	88.00
L.....	86.00

If B. B. is omitted deduct \$8.40
 Hone finished

No. 7407

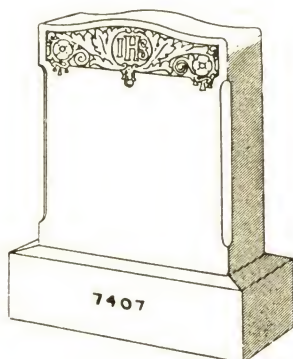

Die.....2.4 x 0.10 x 2.8 .5.2
 B. Base.....2.10 x 1.4 x 1.0 .3.9

Weight complete 1500 lbs.; no B. B. 875 lbs.

D.....	\$138.00
F.....	132.00
G.....	130.00
H.....	127.00
I.....	125.00
K.....	121.00
L.....	117.00

If B. B. is omitted deduct \$13.15

No. 7407¹/₄

Die.....2.0 x 0.8 x 2.6 .3.4
 B. Base.....2.6 x 1.2 x 0.10 .2.5

Weight complete 950 lbs.; no B. B. 515 lbs.

D.....	\$104.00
F.....	100.00
G.....	98.50
H.....	97.00
I.....	95.50
K.....	93.00
L.....	90.50

If B. B. is omitted deduct \$8.70

No. 7407¹/₂

Die.....1.8 x 0.6 x 2.4 .1.11
 B. Base.....2.2 x 1.0 x 0.10 .1.10

Weight complete 650 lbs.; no B. B. 320 lbs.

D.....	\$71.00
F.....	69.00
G.....	68.00
H.....	67.00
I.....	66.00
K.....	64.50
L.....	63.50

If B. B. is omitted deduct \$6.60

No. 7408

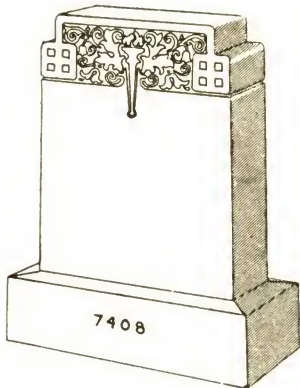

Die.....2. 4 x 0.10 x 2.10..5.6
 B. Base... 2.10 x 1. 4 x 1. 0..3.9
 Weight complete 1600 lbs.; no B. B. 925 lbs.

D.....	\$89.50
F.....	84.50
G.....	81.50
H.....	79.00
I.....	76.00
K.....	72.00
L.....	68.00

If B. B. is omitted deduct \$13.15
 Tracing raised $\frac{1}{4}$ inch. Face only polished; balance sand finished.

No. 7408 $\frac{1}{4}$

Die.....2.0 x 0.8 x 2. 8..3.7
 B. Base... 2.6 x 1.2 x 0.10..2.5
 Weight complete 1050 lbs.; no B. B. 615 lbs.

D.....	\$62.00
F.....	58.00
G.....	56.50
H.....	54.50
I.....	53.00
K.....	50.00
L.....	47.50

If B. B. is omitted deduct \$8.70
 Tracing raised $\frac{1}{4}$ inch. Face only polished; balance sand finished.

No. 7408 $\frac{1}{2}$

Die.....1.8 x 0.6 x 2. 6..2. 1
 B. Base... 2.2 x 1.0 x 0.10..1.10
 Weight complete 675 lbs.; no B. B. 345 lbs.

D.....	\$41.00
F.....	39.00
G.....	38.00
H.....	36.75
I.....	35.75
K.....	34.25
L.....	32.75

If B. B. is omitted deduct \$6.60
 Tracing raised $\frac{1}{4}$ inch. Face only polished; balance sand finished.

No. 7409



Die.....2.6 x 1. 0 x 3.0..7.6
 B. Ba. (S.S.) .3.6 x 1.10 x 1.0..6.5
 Weight complete 2350 lbs.

D.....	\$160.00
F.....	152.00
G.....	149.00
H.....	145.00
I.....	141.00
K.....	135.00
L.....	130.00

"M. M." finish

No. 7409 $\frac{1}{4}$

Die.....2.6 x 0.10 x 3.0..6. 3
 B. Ba. (S.S.) .3.6 x 1. 8 x 1.0..5.10
 Weight complete 2050 lbs.

D.....	\$140.00
F.....	134.00
G.....	131.00
H.....	128.00
I.....	125.00
K.....	120.00
L.....	115.00

"M. M." finish

No. 7409 $\frac{1}{2}$

Die.....2.6 x 0.8 x 3.0..5.0
 B. Ba. (S.S.) .3.6 x 1.4 x 1.0..4.8
 Weight complete 1650 lbs.

D.....	\$115.00
F.....	111.00
G.....	108.00
H.....	106.00
I.....	103.00
K.....	99.50
L.....	95.50

"M. M." finish

No. 7410

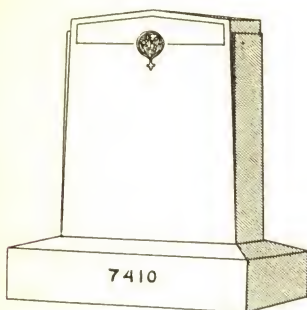

Die..... 2.6 x 1. 0 x 3.0 ..7.6
 B. Ba. (S.S.) .3.6 x 1.10 x 1.0 ..6.5

Weight complete 2350 lbs.

D.....	\$166.00
F.....	158.00
G.....	155.00
H.....	151.00
I.....	147.00
K.....	141.00
L.....	136.00

"M. M." finish

No. 7410¹/₄

Die..... 2.6 x 0.10 x 3.0 ..6. 3
 B. Ba. (S.S.) .3.6 x 1. 8 x 1.0 ..5.10

Weight complete 2050 lbs.

D.....	\$147.00
F.....	141.00
G.....	138.00
H.....	135.00
I.....	132.00
K.....	127.00
L.....	122.00

"M. M." finish

No. 7410¹/₂

Die..... 2.6 x 0.8 x 3.0 ..5.0
 B. Ba. (S.S.) .3.6 x 1.4 x 1.0 ..4.8

Weight complete 1650 lbs.

D.....	\$124.00
F.....	120.00
G.....	117.00
H.....	115.00
I.....	112.00
K.....	108.00
L.....	105.00

"M. M." finish

No. 7411

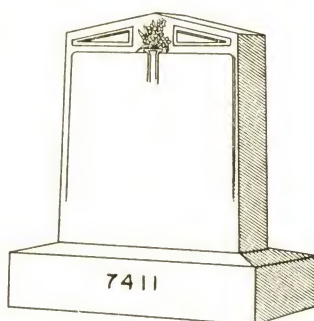

Die..... 3.0 x 1. 0 x 4.0 ..12.0
 B. Ba. (S.S.) .4.0 x 1.10 x 1.0 ..7. 4

Weight complete 3390 lbs.

D.....	\$282.00
F.....	270.00
G.....	264.00
H.....	258.00
I.....	250.00
K.....	243.00
L.....	234.00

"M. M." finish

No. 7411¹/₄

Die..... 3.0 x 0.10 x 4.0 ..10.0
 B. Ba. (S.S.) .4.0 x 1. 8 x 1.0 ..6. 8

Weight complete 2900 lbs.

D.....	\$253.00
F.....	243.00
G.....	238.00
H.....	233.00
I.....	228.00
K.....	221.00
L.....	213.00

"M. M." finish

No. 7411¹/₂

Die..... 2.8 x 0.10 x 3.6 ..7.9
 B. Ba. (S.S.) .3.8 x 1. 8 x 1.0 ..6. 1

Weight complete 2400 lbs.

D.....	\$222.00
F.....	214.00
G.....	209.00
H.....	206.00
I.....	203.00
K.....	197.00
L.....	191.00

"M. M." finish

No. 7411³/₄

Die..... 2.8 x 0.8 x 3.6 ..6. 3
 B. Ba. (S.S.) .3.8 x 1.4 x 1.0 ..4.11

Weight complete 1950 lbs.

D.....	197.00
F.....	191.00
G.....	188.00
H.....	185.00
I.....	182.00
K.....	177.00
L.....	172.00

"M. M." finish

No. 7412

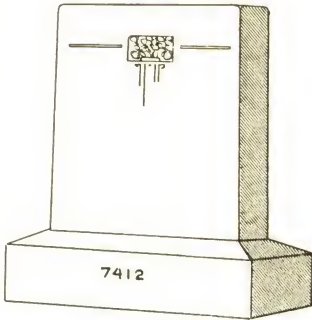

Die.....2.6 x 1. 0 x 3.0..7.6
 B. Ba. (S.S.)..3.6 x 1.10 x 1.0..6.5

Weight complete 2350 lbs.

D.....	\$153.00
F.....	145.00
G.....	142.00
H.....	138.00
I.....	134.00
K.....	128.00
L.....	123.00

"M. M." finish

No. 7413

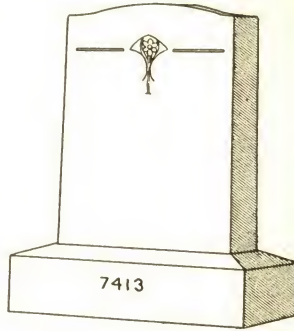

Die.....2.4 x 1. 0 x 3.6..8.2
 B. Ba. (S.S.)..3.4 x 1.10 x 1.0..6.1

Weight complete 2400 lbs.

D.....	\$151.00
F.....	143.00
G.....	139.00
H.....	135.00
I.....	131.00
K.....	125.00
L.....	118.00

"M. M." finish

No. 7412¹/₄

Die.....2.6 x 0.10 x 3.0..6. 3
 B.Ba. (S.S.)..3.6 x 1. 8 x 1.0..5.10

Weight complete 2050 lbs.

D.....	\$139.00
F.....	133.00
G.....	130.00
H.....	127.00
I.....	124.00
K.....	119.00
L.....	114.00

"M. M." finish

No. 7413¹/₄

Die.....2.4 x 0.10 x 3.6..6.10
 B.Ba. (S.S.)..3.4 x 1. 8 x 1.0..5. 7

Weight complete 2150 lbs.

D.....	\$133.00
F.....	127.00
G.....	123.00
H.....	120.00
I.....	116.00
K.....	111.00
L.....	106.00

"M. M." finish

No. 7412¹/₂

Die.....2.6 x 0.8 x 3.0..5.0
 B. Ba. (S.S.)..3.6 x 1.4 x 1.0..4.8

Weight complete 1650 lbs.

D.....	\$113.00
F.....	109.00
G.....	106.00
H.....	104.00
I.....	101.00
K.....	97.00
L.....	93.50

"M. M." finish

No. 7413¹/₂

Die.....2.4 x 0.8 x 3.6..5.5
 B. Ba. (S.S.)..3.4 x 1.4 x 1.0..4.5

Weight complete 1700 lbs.

D.....	\$111.00
F.....	105.00
G.....	103.00
H.....	100.00
I.....	97.00
K.....	93.00
L.....	89.00

"M. M." finish

No. 7414

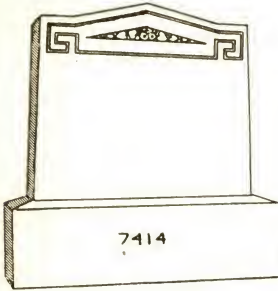

Die.....3.2 x 1.0 x 2.8 .8.5
 B. Ba. (S.S.)...4.0 x 1.8 x 1.0 .6.8

Weight complete 2600 lbs.

D.....	\$181.00
F.....	173.00
G.....	169.00
H.....	164.00
I.....	159.00
K.....	154.00
L.....	148.00

"M. M." finish

No. 7415

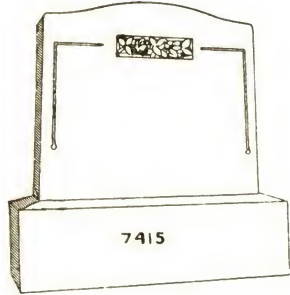

Die.....3.2 x 1.0 x 2.8 .8.5
 B. Ba. (S.S.)...4.0 x 1.8 x 1.0 .6.8

Weight complete 2600 lbs.

D.....	\$181.00
F.....	173.00
G.....	169.00
H.....	164.00
I.....	160.00
K.....	154.00
L.....	148.00

"M. M." finish

No. 7414¹/₄

Die.....2.10 x 0.10 x 2.4 .5.6
 B.Ba. (S.S.) .3. 6 x 1. 4 x 1.0 .4.8

Weight complete 1775 lbs.

D.....	\$125.00
F.....	119.00
G.....	117.00
H.....	114.00
I.....	111.00
K.....	107.00
L.....	103.00

"M. M." finish

No. 7415¹/₄

Die.....2.10 x 0.10 x 2.4 .5.6
 B.Ba. (S.S.) .3. 6 x 1. 4 x 1.0 .4.8

Weight complete 1775 lbs.

D.....	\$125.00
F.....	119.00
G.....	117.00
H.....	114.00
I.....	111.00
K.....	107.00
L.....	103.00

"M. M." finish

No. 7414¹/₂

Die.....2.10 x 0.8 x 2.4 .4.5
 B. Ba. (S.S.) .3. 6 x 1.2 x 1.0 .4.1

Weight complete 1475 lbs.

D.....	\$109.00
F.....	105.00
G.....	103.00
H.....	101.00
I.....	98.00
K.....	95.00
L.....	91.50

"M. M." finish

No. 7415¹/₂

Die.....2.10 x 0.8 x 2.4 .4.5
 B. Ba. (S.S.) .3. 6 x 1.2 x 1.0 .4.1

Weight complete 1475 lbs.

D.....	\$109.00
F.....	105.00
G.....	103.00
H.....	101.00
I.....	98.00
K.....	95.00
L.....	91.50

"M. M." finish

No. 7416

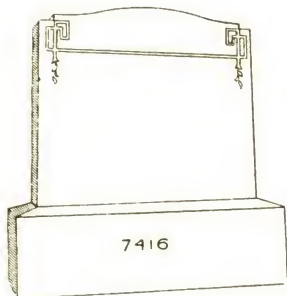

Die.....3.2 x 1.0 x 2.8..8.5
 B. Ba. (S.S.)...4.0 x 1.8 x 1.0..6.8

Weight complete 2600 lbs.

D.....	\$171.00
F.....	163.00
G.....	159.00
H.....	154.00
I.....	150.00
K.....	144.00
L.....	138.00

"M. M." finish

No. 7416¹/₄

Die.....2.10 x 0.10 x 2.4..5.6
 B.Ba. (S.S.) .3. 6 x 1. 4 x 1.0..4.8

Weight complete 1775 lbs.

D.....	\$115.00
F.....	109.00
G.....	107.00
H.....	104.00
I.....	101.00
K.....	97.00
L.....	93.00

"M. M." finish

No. 7416¹/₂

Die.....2.10 x 0.8 x 2.4..4.5
 B. Ba. (S.S.) .3. 6 x 1.2 x 1.0..4.1

Weight complete 1475 lbs.

D.....	\$99.00
F.....	95.00
G.....	93.00
H.....	90.50
I.....	88.00
K.....	85.00
L.....	81.50

"M. M." finish

No. 7417

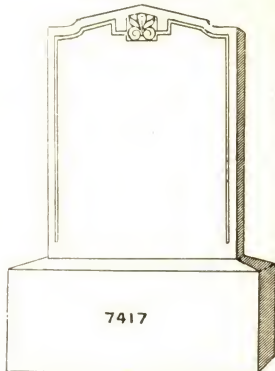

Die.....1.6 x 0.6 x 2. 0..1.6
 B. Base.....2.0 x 1.0 x 0.10..1.8

Weight complete 550 lbs.; no B. B. 250 lbs.

D.....	\$33.25
F.....	31.75
G.....	31.00
H.....	30.25
I.....	29.50
K.....	28.25
L.....	27.25

If B. B. is omitted deduct \$6.00

No. 7417¹/₄

Die.....1.6 x 0. 4 x 2. 0..1.0
 B. Base.....2.0 x 0.10 x 0.10..1.5

Weight complete 425 lbs.; no B. B. 170 lbs.

D.....	\$26.50
F.....	25.50
G.....	25.00
H.....	24.50
I.....	24.00
K.....	23.25
L.....	22.50

If B. B. is omitted deduct \$5.10

No. 7417¹/₂

Die.....1.4 x 0.4 x 1. 8..0.9
 B. Base.....1.9 x 0.9 x 0.10..1.1

Weight complete 325 lbs.; no B. B. 130 lbs.

D.....	\$20.50
F.....	19.50
G.....	19.25
H.....	18.75
I.....	18.50
K.....	18.00
L.....	17.25

If B. B. is omitted deduct \$3.90

No. 7418

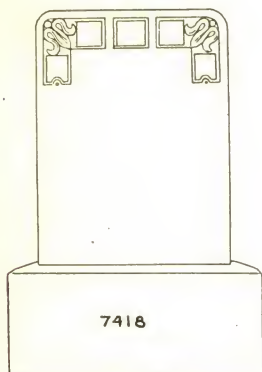

Sizes and prices same as No. 7417.

No. 7420

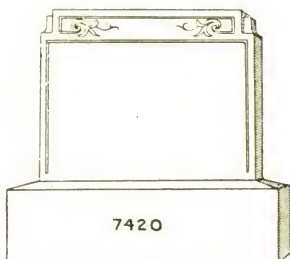

Die.....1. 6 x 0.4 x 1.2..0.7
 B. Base.....1.10 x 0.8 x 0.6..0.7
 Weight complete 210 lbs.; no B. B. 105 lbs.

D.....	\$13.75
F.....	13.25
G.....	13.00
H.....	12.50
I.....	12.25
K.....	12.00
L.....	11.50

If B. B. is omitted deduct \$2.20

No. 7419

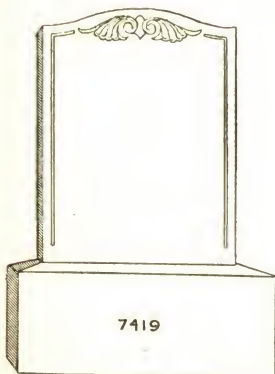

Sizes and prices same as No. 7417.

No. 7420¹/₄

Die.....1.4 x 0.4 x 1.0..0.5
 B. Base.....1.8 x 0.8 x 0.6..0.7
 Weight complete 180 lbs.; no B. B. 75 lbs.

D.....	\$11.50
F.....	11.25
G.....	11.00
H.....	10.75
I.....	10.50
K.....	10.00
L.....	9.75

If B. B. is omitted deduct \$2.20

No. 7421

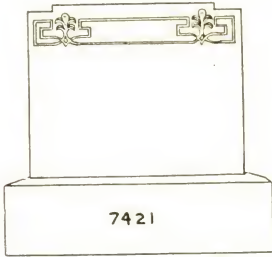

Sizes and prices same as No. 7420.

No. 7423

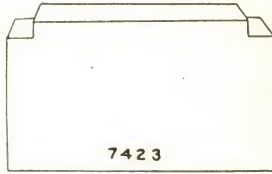

Die.....1.10 x 1.0 x 1.2..2.2

Weight complete 390 lbs.

D.....	\$30.50
F.....	28.50
G.....	27.25
H.....	26.25
I.....	25.25
K.....	23.50
L.....	22.00

No. 7423¹/₄

Die.....1.8 x 0.10 x 1.0..1.5

Weight complete 255 lbs.

D.....	\$21.50
F.....	20.00
G.....	19.25
H.....	18.50
I.....	18.00
K.....	16.75
L.....	15.75

No. 7422

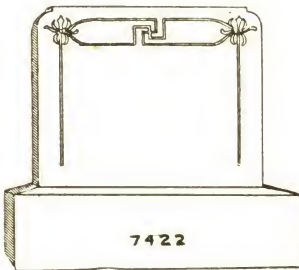

Sizes and prices same as No. 7420.

No. 7423¹/₂

Die.....1.6 x 0.8 x 0.10..0.10

Weight complete 150 lbs.

D.....	\$14.50
F.....	13.50
G.....	12.75
H.....	12.25
I.....	11.75
K.....	11.25
L.....	10.50

No. 7423—A

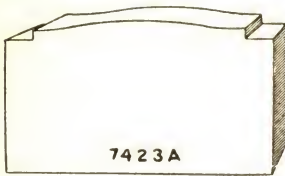

Die.....1.10 x 1.0 x 1.2...2.2

Weight complete 390 lbs.

D.....	\$34.75
F.....	32.75
G.....	31.50
H.....	30.50
I.....	29.50
K.....	27.75
L.....	26.25

Hone finished

No. 7423—B

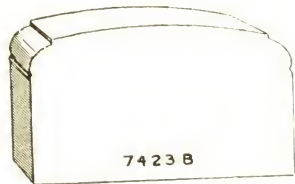

Die.....1.10 x 1.0 x 1.2...2.2

Weight complete 390 lbs.

D.....	\$34.00
F.....	32.00
G.....	30.75
H.....	29.75
I.....	28.75
K.....	27.00
L.....	25.50

"M. M." finish

No. 7423¹/₄—A

Die.....1.8 x 0.10 x 1.0...1.5

Weight complete 255 lbs.

D.....	\$25.75
F.....	24.25
G.....	23.50
H.....	22.75
I.....	22.25
K.....	21.00
L.....	20.00

Hone finished

No. 7423¹/₄—B

Die.....1.8 x 0.10 x 1.0...1.5

Weight complete 255 lbs.

D.....	\$24.00
F.....	22.50
G.....	21.75
H.....	21.00
I.....	20.50
K.....	19.25
L.....	18.25

"M. M." finish

No. 7423¹/₂—A

Die.....1.6 x 0.8 x 0.10...0.10

Weight complete 150 lbs.

D.....	\$17.50
F.....	16.50
G.....	16.25
H.....	15.75
I.....	15.25
K.....	14.75
L.....	14.00

Hone finished

No. 7423¹/₂—B

Die.....1.6 x 0.8 x 0.10...0.10

Weight complete 150 lbs.

D.....	\$16.00
F.....	15.00
G.....	14.75
H.....	14.25
I.....	13.75
K.....	13.25
L.....	12.50

"M. M." finish

No. 7424

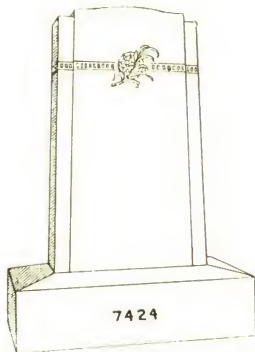

Die.....2.6 x 1.0 x 4.2...10.5
 B.Ba. (S.S.) .3.8 x 1.10 x 1.0...6.9

Weight complete 2900 lbs.

D.....	\$215.00
F.....	205.00
G.....	200.00
H.....	194.00
I.....	189.00
K.....	181.00
L.....	174.00

Sand finished

No. 7424¹/₄

Die.....2.4 x 0.10 x 4.0...7.9
 B.Ba. (S.S.) .3.6 x 1.8 x 1.0...5.10

Weight complete 2300 lbs.

D.....	\$178.00
F.....	170.00
G.....	166.00
H.....	162.00
I.....	159.00
K.....	153.00
L.....	147.00

Sand finished

No. 7424¹/₂

Die.....2.4 x 0.8 x 4.0...6.3
 B. Ba. (S.S.) .3.6 x 1.6 x 1.0...5.3

Weight complete 1975 lbs.

D.....	\$155.00
F.....	149.00
G.....	146.00
H.....	143.00
I.....	140.00
K.....	135.00
L.....	130.00

Sand finished

No. 7425

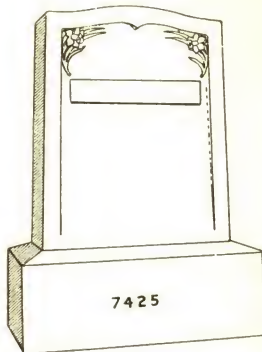

Die.....2.4 x 0.10 x 3.0...5.10
 B.Ba. (S.S.) .2.10 x 1.4 x 1.0...3.9

Weight complete 1600 lbs.

D.....	\$135.00
F.....	129.00
G.....	126.00
H.....	123.00
I.....	120.00
K.....	116.00
L.....	112.00

"M. M." finish

No. 7425¹/₄

Die.....2.0 x 0.8 x 2.6...3.4
 B. Ba. (S.S.) .2.6 x 1.2 x 1.0...2.11

Weight complete 1075 lbs.; no B. B. 550 lbs.

D.....	\$97.50
F.....	94.50
G.....	92.50
H.....	91.00
I.....	89.50
K.....	87.00
L.....	84.50

"M. M." finish

No. 7425¹/₂

Die.....1.8 x 0.6 x 2.4...1.11
 B.Ba. (S.S.) .2.2 x 1.0 x 0.10...1.10

Weight complete 650 lbs.; no B. B. 320 lbs.

D.....	\$72.00
F.....	70.00
G.....	69.00
H.....	68.00
I.....	67.00
K.....	65.50
L.....	64.50

"M. M." finish

No. 7426

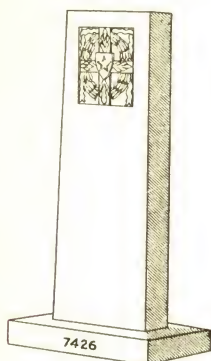

Die.....2.0 x 0.10 x 5.0 8. 4
 B.Ba. (S.S.) .3.0 x 1.10 x 0.4 1.10

Weight complete 1800 lbs.

D.....	\$192.00
F.....	184.00
G.....	180.00
H.....	176.00
I.....	171.00
K.....	165.00
L.....	159.00

No. 7426¹/₄

Die.....1.10 x 0.8 x 4.10 5.11
 B.Ba. (S.S.) .2.10 x 1.8 x 0.4 1.7

Weight complete 1300 lbs.

D.....	\$154.00
F.....	148.00
G.....	145.00
H.....	142.00
I.....	139.00
K.....	135.00
L.....	130.00

No. 7426¹/₂

Die.....1.10 x 0.6 x 4.10 4.5
 B.Ba. (S.S.) .2.10 x 1.6 x 0.4 1.5

Weight complete 1025 lbs.

D.....	\$132.00
F.....	129.00
G.....	127.00
H.....	124.00
I.....	122.00
K.....	119.00
L.....	116.00

No. 7427

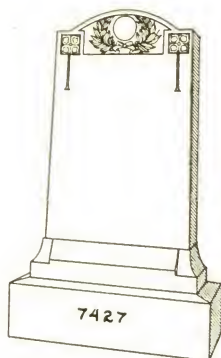

Die.....2.6 x 0.10 x 4.0 8.4
 Base.....2.10 x 1.2 x 0.8 2.2
 B.Ba. (S.S.) .3.4 x 1.8 x 1.0 5.7

Weight complete 2700 lbs.

D.....	\$190.00
F.....	180.00
G.....	175.00
H.....	169.00
I.....	164.00
K.....	156.00
L.....	148.00

No. 7427¹/₄

Die.....2.6 x 0.8 x 4.0 6.8
 Base.....2.10 x 1.0 x 0.8 1.11
 B.Ba. (S.S.) .3.4 x 1.6 x 1.0 5.0

Weight complete 2300 lbs.

D.....	\$161.00
F.....	153.00
G.....	148.00
H.....	144.00
I.....	140.00
K.....	133.00
L.....	127.00

No. 7429³/₄

Die.....1.8 x 0.6 x 2.4 1.11
 B.Ba. (S.S.) .2.2 x 1.0 x 0.10 1.10

Weight complete 675 lbs.

D.....	\$52.00
F.....	50.00
G.....	49.00
H.....	48.00
I.....	47.25
K.....	45.75
L.....	44.25

"M. M." finish

No. 7428

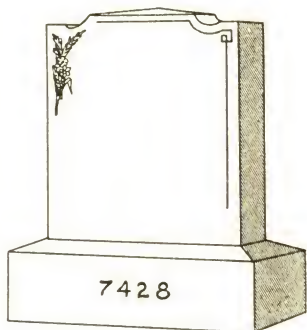

Die.....2.6 x 1. 0 x 2.8. .6.8
 B. Ba. (S.S.)...3.4 x 1.10 x 1.0. .6.1

Weight complete 2200 lbs.

D.....	\$161.00
F.....	155.00
G.....	151.00
H.....	148.00
I.....	145.00
K.....	140.00
L.....	135.00

"M. M." finish

No. 7428¹/₄

Die.....2.4 x 0.10 x 2.6. .4.10
 B.Ba. (S.S.) .3.0 x 1. 6 x 1.0. .4. 6

Weight complete 1575 lbs.

D.....	\$129.00
F.....	125.00
G.....	122.00
H.....	120.00
I.....	117.00
K.....	112.00
L.....	110.00

"M. M." finish

No. 7428¹/₂

Die.....2.4 x 0.8 x 2.6. .3.11
 B. Ba. (S.S.) .3.0 x 1.4 x 1.0. .4. 0

Weight complete 1250 lbs.

D.....	\$115.00
F.....	111.00
G.....	109.00
H.....	107.00
I.....	105.00
K.....	102.00
L.....	99.00

"M. M." finish

No. 7429

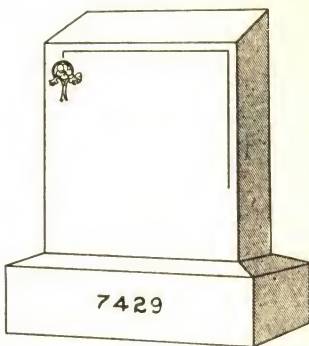

Die.....2.0 x 1.0 x 2.6. .5.0
 B. Ba. (S.S.)...2.6 x 1.6 x 1.0. .3.9

Weight complete 1575 lbs.

D.....	\$100.00
F.....	96.00
G.....	93.00
H.....	90.50
I.....	88.00
K.....	84.00
L.....	80.50

"M. M." finish

No. 7429¹/₄

Die.....2.0 x 0.10 x 2.6. .4.2
 B. Ba. (S.S.) .2.6 x 1. 4 x 1.0. .3.4

Weight complete 1350 lbs.

D.....	\$88.00
F.....	84.00
G.....	82.00
H.....	80.00
I.....	77.50
K.....	74.50
L.....	71.50

"M. M." finish

No. 7429¹/₂

Die.....2.0 x 0.8 x 2.6. .3. 4
 B. Ba. (S.S.) .2.6 x 1.2 x 1.0. .2.11

Weight complete 1100 lbs.

D.....	\$76.50
F.....	73.50
G.....	71.50
H.....	70.00
I.....	69.50
K.....	66.00
L.....	63.50

"M. M." finish

No. 7429³/₄

See previous page

No. 7430

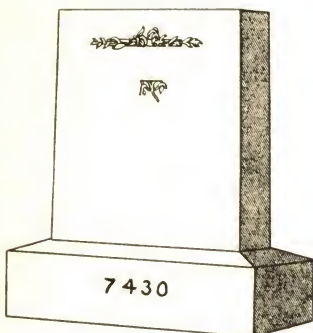

Die.....2.6 x 1. 0 x 3.2 ..7.11
 B.Ba. (S.S.) .3.4 x 1.10 x 1.0 ..6. 1

Weight complete 2500 lbs.

D.....	\$158.00
F.....	151.00
G.....	147.00
H.....	144.00
I.....	140.00
K.....	135.00
L.....	130.00

"M. M." finish

No. 7430¹/₄

Die.....2.4 x 0.10 x 3.0 ..5.10
 B.Ba. (S.S.) .3.2 x 1. 8 x 1.0 ..5. 3

Weight complete 1975 lbs.

D.....	\$128.00
F.....	122.00
G.....	119.00
H.....	116.00
I.....	113.00
K.....	109.00
L.....	105.00

"M. M." finish

No. 7430¹/₂

Die.....2.4 x 0.8 x 3. 0 ..4.8
 B.Ba. (S.S.) .3.2 x 1.6 x 0.10 ..4.0

Weight complete 1560 lbs.

D.....	\$108.00
F.....	104.00
G.....	101.00
H.....	99.00
I.....	96.50
K.....	93.00
L.....	89.50

"M. M." finish

No. 7431

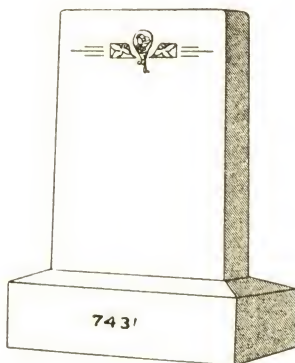

Die.....2.6 x 1. 0 x 3.10 ..9.7
 B.Ba. (S.S.) .3.6 x 1.10 x 1. 0 ..6.5

Weight complete 2850 lbs.

D.....	\$183.00
F.....	173.00
G.....	168.00
H.....	164.00
I.....	159.00
K.....	152.00
L.....	144.00

"M. M." finish

No. 7431¹/₄

Die.....2.6 x 0.10 x 3.10 ..8. 0
 B.Ba. (S.S.) .3.6 x 1. 8 x 1. 0 ..5.10

Weight complete 2475 lbs.

D.....	\$161.00
F.....	153.00
G.....	149.00
H.....	145.00
I.....	141.00
K.....	135.00
L.....	129.00

"M. M." finish

No. 7431¹/₂

Die.....2.6 x 0.8 x 3.10 ..6.5
 B.Ba. (S.S.) .3.6 x 1.6 x 1. 0 ..5.3

Weight complete 2075 lbs.

D.....	\$138.00
F.....	132.00
G.....	129.00
H.....	125.00
I.....	122.00
K.....	117.00
L.....	113.00

"M. M." finish

No. 7432

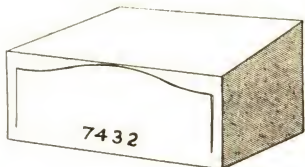

Die.....2.2 x 1.2 x 1.0..2.6

Weight complete 425 lbs.

D.....	\$38.75
F.....	36.25
G.....	35.00
H.....	33.75
I.....	32.50
K.....	30.00
L.....	28.75

"M. M." finish

No. 7433

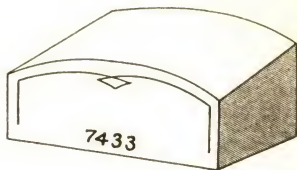

Sizes and prices same as No. 7432.

No. 7432¹/₄

Die.....2.0 x 1.0 x 1.0..2.0

Weight complete 350 lbs.

D.....	\$31.50
F.....	29.50
G.....	28.50
H.....	27.50
I.....	26.50
K.....	25.00
L.....	23.50

"M. M." finish

No. 7434

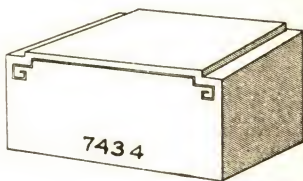

Sizes and prices same as No. 7432.

No. 7432¹/₂

Die.....1.10 x 0.10 x 0.10..1.3

Weight complete 210 lbs.

D.....	\$22.25
F.....	20.75
G.....	20.25
H.....	19.50
I.....	19.00
K.....	18.00
L.....	17.00

"M. M." finish

No. 7435

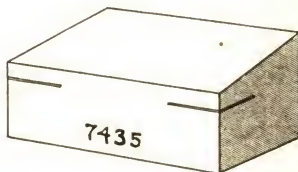

Sizes and prices same as No. 7432.

No. 7436

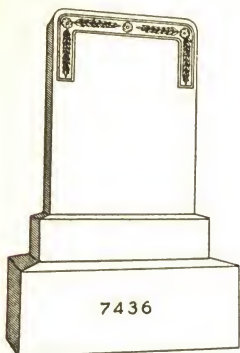

Die.....1.6 x 0.6 x 2. 0. .1.6
 Base.....1.9 x 0.9 x 0. 5. .0.7
 B. Base.....2.2 x 1.2 x 0.10. .2.1

Weight complete 750 lbs.; no B. B. 375 lbs.

D.....	\$41.00
F.....	39.00
G.....	38.00
H.....	36.75
I.....	35.75
K.....	34.25
L.....	32.75

If B. B. is omitted deduct \$7.50

No. 7437

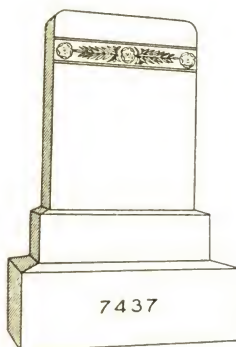

Die.....1.6 x 0.6 x 2. 0. .1.6
 Base.....1.9 x 0.9 x 0. 5. .0.7
 B. Base.....2.2 x 1.2 x 0.10. .2.1

Weight complete 750 lbs.; no B. B. 375 lbs.

D.....	\$41.00
F.....	39.00
G.....	38.00
H.....	36.75
I.....	35.75
K.....	34.25
L.....	32.75

If B. B. is omitted deduct \$7.50

No. 7436¹/₄

Die.....1.6 x 0.4 x 2. 0. .1. 0
 Base.....1.9 x 0.7 x 0. 4. .0. 4
 B. Base.....2.2 x 1.0 x 0.10. .1.10

Weight complete 550 lbs.; no B. B. 220 lbs.

D.....	\$30.75
F.....	29.25
G.....	28.75
H.....	28.00
I.....	27.25
K.....	26.25
L.....	25.25

If B. B. is omitted deduct \$6.60

No. 7437¹/₄

Die.....1.6 x 0.4 x 2. 0. .1. 0
 Base.....1.9 x 0.7 x 0. 4. .0. 4
 B. Base.....2.2 x 1.0 x 0.10. .1.10

Weight complete 550 lbs.; no B. B. 220 lbs.

D.....	\$30.75
F.....	29.25
G.....	28.75
H.....	28.00
I.....	27.25
K.....	26.25
L.....	25.25

If B. B. is omitted deduct \$6.60

No. 7438

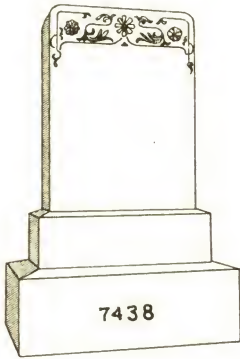

Die.....1.6 x 0.6 x 2. 0. .1.6
 Base.....1.9 x 0.9 x 0. 5. .0.7
 B. Base.....2.2 x 1.2 x 0.10. .2.1

Weight complete 750 lbs.; no B. B. 375 lbs.

D.....	\$41.00
F.....	39.00
G.....	38.00
H.....	36.75
I.....	35.75
K.....	34.25
L.....	32.75

If B. B. is omitted deduct \$7.50

No. 7439

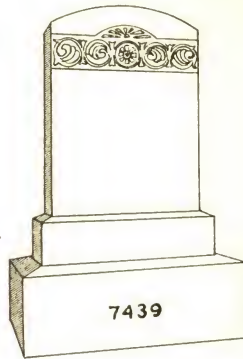

Die.....1.6 x 0.6 x 2. 0. .1.6
 Base.....1.9 x 0.9 x 0. 5. .0.7
 B. Base.....2.2 x 1.2 x 0.10. .2.1

Weight complete 750 lbs.; no B. B. 375 lbs.

D.....	\$42.00
F.....	40.00
G.....	39.00
H.....	37.75
I.....	36.75
K.....	35.25
L.....	33.75

If B. B. is omitted deduct \$7.50

No. 7438¹/₄

Die.....1.6 x 0.4 x 2. 0. .1. 0
 Base.....1.9 x 0.7 x 0. 4. .0. 4
 B. Base.....2.2 x 1.0 x 0.10. .1.10

Weight complete 550 lbs.; no B. B. 220 lbs.

D.....	\$30.75
F.....	29.25
G.....	28.75
H.....	28.00
I.....	27.25
K.....	26.25
L.....	25.25

If B. B. is omitted deduct \$6.60

No. 7439¹/₄

Die.....1.6 x 0.4 x 2. 0. .1. 0
 Base.....1.9 x 0.7 x 0. 4. .0. 4
 B. Base.....2.2 x 1.0 x 0.10. .1.10

Weight complete 550 lbs.; no B. B. 220 lbs.

D.....	\$31.75
F.....	30.25
G.....	29.75
H.....	29.00
I.....	28.25
K.....	27.25
L.....	26.25

If B. B. is omitted deduct \$6.60

No. 7440

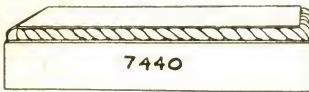

Die.....2.0 x 1.0 x 0.6...1.0

Weight complete 180 lbs.

D.....	\$19.25
F.....	18.25
G.....	17.75
H.....	17.25
I.....	16.75
K.....	16.00
L.....	15.25

Top panel polished; balance sand finished

No. 7440—A

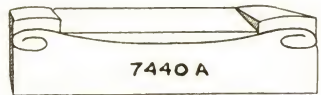

Die.....2.0 x 1.0 x 0.6...1.0

Weight complete 180 lbs.

D.....	\$19.25
F.....	18.25
G.....	17.75
H.....	17.25
I.....	16.75
K.....	16.00
L.....	15.25

No. 7440¹/₄

Die.....1.8 x 1.0 x 0.6...0.10

Weight complete 150 lbs.

D.....	\$17.50
F.....	16.50
G.....	16.25
H.....	15.75
I.....	15.25
K.....	14.75
L.....	14.00

Top panel polished; balance sand finished

No. 7440¹/₄—A

Die.....1.8 x 1.0 x 0.6...0.10

Weight complete 150 lbs.

D.....	\$17.50
F.....	16.50
G.....	16.25
H.....	15.75
I.....	15.25
K.....	14.75
L.....	14.00

No. 7440¹/₂

Die.....1.10 x 0.10 x 0.6...0.9

Weight complete 135 lbs.

D.....	\$14.00
F.....	13.50
G.....	13.00
H.....	12.75
I.....	12.50
K.....	12.00
L.....	11.50

Top panel polished; balance sand finished

No. 7440¹/₂—A

Die.....1.10 x 0.10 x 0.6...0.9

Weight complete 135 lbs.

D.....	\$14.00
F.....	13.50
G.....	13.00
H.....	12.75
I.....	12.50
K.....	12.00
L.....	11.50

No. 7441

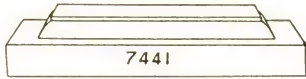

Die.....2.6 x 1.8 x 0.6...2.1

Weight complete 375 lbs.

D.....	\$33.50
F.....	31.50
G.....	30.50
H.....	29.25
I.....	28.25
K.....	26.75
L.....	25.25

No. 7441—A

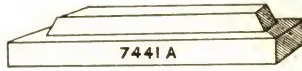

Die.....2.6 x 1.8 x 0.6...2.1

Weight complete 375 lbs.

D.....	\$31.00
F.....	29.00
G.....	28.00
H.....	26.75
I.....	25.75
K.....	24.25
L.....	22.75

No. 7441¹/₄

Die.....2.4 x 1.6 x 0.6...1.9

Weight complete 315 lbs.

D.....	\$28.50
F.....	26.50
G.....	25.75
H.....	24.75
I.....	24.00
K.....	22.75
L.....	21.25

No. 7441¹/₄—A

Die.....2.4 x 1.6 x 0.6...1.9

Weight complete 315 lbs.

D.....	\$26.25
F.....	24.25
G.....	23.50
H.....	22.50
I.....	21.75
K.....	20.50
L.....	19.00

No. 7441¹/₂

Die.....2.2 x 1.4 x 0.6...1.5

Weight complete 255 lbs.

D.....	\$23.75
F.....	22.25
G.....	21.50
H.....	20.75
I.....	20.25
K.....	19.00
L.....	18.00

No. 7441¹/₂—A

Die.....2.2 x 1.4 x 0.6...1.5

Weight complete 255 lbs.

D.....	\$21.75
F.....	20.25
G.....	19.50
H.....	18.75
I.....	18.25
K.....	17.00
L.....	16.00

No. 7441³/₄

Die.....2.0 x 1.2 x 0.6...1.2

Weight complete 210 lbs.

D.....	\$20.25
F.....	19.25
G.....	18.50
H.....	18.00
I.....	17.50
K.....	16.50
L.....	15.75

No. 7441³/₄—A

Die.....2.0 x 1.2 x 0.6...1.2

Weight complete 210 lbs.

D.....	\$18.50
F.....	17.50
G.....	16.75
H.....	16.25
I.....	15.75
K.....	14.75
L.....	14.00

No. 7441—B

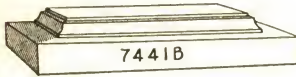

Die.....2.6 x 1.8 x 0.6...2.1

Weight complete 375 lbs.

D.....	\$36.00
F.....	34.00
G.....	33.00
H.....	31.75
I.....	30.75
K.....	29.25
L.....	27.75

No. 7441¹/₄—B

Die.....2.4 x 1.6 x 0.6...1.9

Weight complete 315 lbs.

D.....	\$31.00
F.....	29.00
G.....	28.25
H.....	27.25
I.....	26.50
K.....	25.25
L.....	23.75

No. 7441¹/₂—B

Die.....2.2 x 1.4 x 0.6...1.5

Weight complete 255 lbs.

D.....	\$26.00
F.....	\$24.50
G.....	23.75
H.....	23.00
I.....	22.50
K.....	21.25
L.....	20.25

No. 7441³/₄—B

Die.....2.0 x 1.2 x 0.6...1.2

Weight complete 210 lbs.

D.....	\$22.50
F.....	21.50
G.....	20.75
H.....	20.25
I.....	19.75
K.....	18.75
L.....	18.00

No. 7442

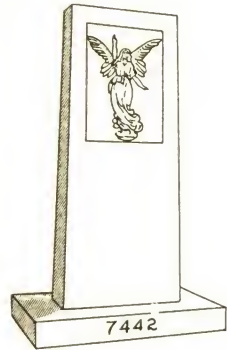

Die.....2.0 x 0.10 x 5.0...S. 4

B. Base....3.0 x 1.10 x 0.4...1.10

Weight complete 1800 lbs.

D.....	\$164.00
F.....	156.00
G.....	152.00
H.....	148.00
I.....	143.00
K.....	137.00
L.....	131.00

No. 7442¹/₄

Die.....1.10 x 0.8 x 4.10...5.11

B. Base....2.10 x 1.8 x 0.4...1.7

Weight complete 1225 lbs.

D.....	\$128.00
F.....	122.00
G.....	119.00
H.....	116.00
I.....	113.00
K.....	109.00
L.....	104.00

No. 7443—B

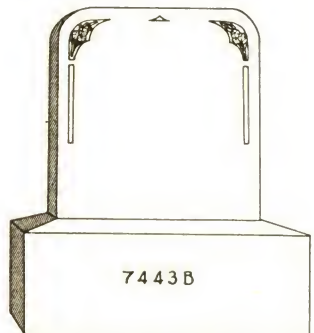

Sizes and prices same as No. 7443.

No. 7443



Die.....1.6 x 0.6 x 1.6..1.2
 B. Base.....2.0 x 1.0 x 0.8..1.4
 Weight complete 450 lbs.; no B. B. 210 lbs.
 D.....\$30.00
 F.....29.00
 G.....28.25
 H.....27.75
 I.....27.25
 K.....26.25
 L.....25.50
 If B. B. is omitted deduct \$4.80

No. 7443¹/₄

Die.....1.4 x 0.4 x 1.4..0.7
 B. Base.....1.8 x 0.8 x 0.8..0.9
 Weight complete 240 lbs.; no B. B. 105 lbs.
 D.....\$19.75
 F.....19.25
 G.....19.00
 H.....18.50
 I.....18.25
 K.....18.00
 L.....17.50
 If B. B. is omitted deduct \$2.80

No. 7443—A

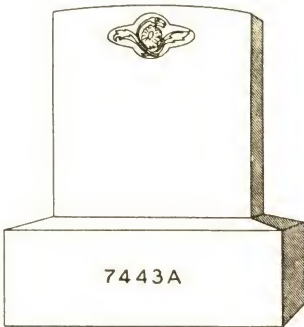

Sizes and prices same as No. 7443.

7443—B

See previous page

No. 7444

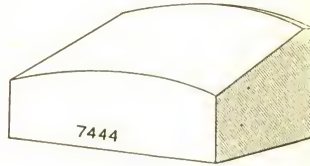

Die.....2.2 x 1.4 x 1.2..3.4
 Weight complete 575 lbs.
 D.....\$46.75
 F.....43.25
 G.....41.75
 H.....40.00
 I.....38.25
 K.....35.75
 L.....33.25

"M. M." finish

No. 7444¹/₄

Die.....2.0 x 1.2 x 1.0..2.4
 Weight complete 400 lbs.
 D.....\$33.25
 F.....30.75
 G.....29.75
 H.....28.50
 I.....27.25
 K.....25.50
 L.....23.75

"M. M." finish

No. 7444¹/₂

Die.....1.10 x 1.0 x 0.10..1.6
 Weight complete 260 lbs.
 D.....\$22.75
 F.....21.25
 G.....20.50
 H.....19.75
 I.....19.00
 K.....17.75
 L.....16.75

"M. M." finish

No. 7445

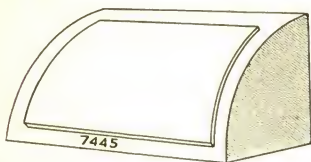

Die.....2.2 x 1.2 x 1.2 . . 2.11

Weight complete 860 lbs.

D.....	\$42.50
F.....	39.50
G.....	38.00
H.....	36.50
I.....	35.25
K.....	33.00
L.....	30.75

"M. M." finish

No. 7446

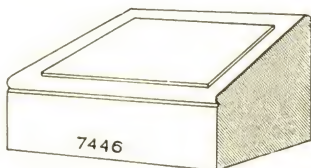

Die.....2.2 x 1.4 x 1.2 . . 3.4

Weight complete 575 lbs.

D.....	\$51.75
F.....	49.25
G.....	47.75
H.....	46.00
I.....	44.25
K.....	41.75
L.....	39.25

"M. M." finish

No. 7445¹/₄

Die.....2.0 x 1.0 x 1.0 . . 2.0

Weight complete 700 lbs.

D.....	\$30.00
F.....	28.00
G.....	27.00
H.....	26.00
I.....	25.00
K.....	23.50
L.....	22.00

"M. M." finish

No. 7446¹/₄

Die.....2.0 x 1.2 x 1.0 . . 2.4

Weight complete 400 lbs.

D.....	\$39.25
F.....	36.75
G.....	35.75
H.....	34.50
I.....	33.25
K.....	31.50
L.....	29.75

"M. M." finish

No. 7445¹/₂

Die.....1.10 x 0.10 x 0.10 . . 1.3

Weight complete 215 lbs.

D.....	\$20.75
F.....	19.25
G.....	18.75
H.....	18.00
I.....	17.50
K.....	16.50
L.....	15.50

"M. M." finish

No. 7446¹/₂

Die.....1.10 x 1.0 x 0.10 . . 1.6

Weight complete 260 lbs.

D.....	\$27.75
F.....	26.25
G.....	25.50
H.....	24.75
I.....	24.00
K.....	22.75
L.....	21.75

"M. M." finish

No. 7447

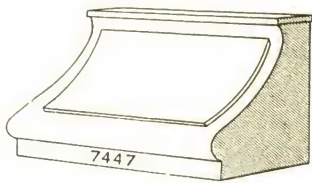

Die.....2.4 x 1.4 x 1.8..5.2
Weight complete 800 lbs.

D.....	\$79.50
F.....	74.50
G.....	71.75
H.....	69.25
I.....	66.75
K.....	62.75
L.....	59.00

"M. M." finish

No. 7447¹/₄

Die.....2.0 x 1.2 x 1.6..3.6
Weight complete 545 lbs.

D.....	\$59.50
F.....	56.50
G.....	54.50
H.....	53.00
I.....	51.00
K.....	48.25
L.....	45.75

"M. M." finish

No. 7447¹/₂

Die.....1.10 x 1.0 x 1.4..2.5
Weight complete 415 lbs.

D.....	\$46.25
F.....	43.75
G.....	42.50
H.....	41.25
I.....	40.25
K.....	38.25
L.....	36.50

"M. M." finish

No. 7448

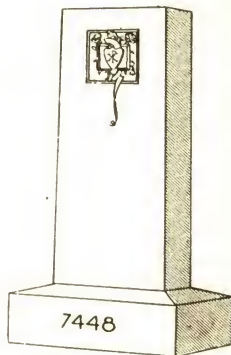

Die.....2.0 x 0.10 x 5.0..8.4
B.Ba. (S.S.) 2.10 x 1.6 x 0.10..3.7

Weight complete 2100 lbs.

D.....	\$176.00
F.....	168.00
G.....	164.00
H.....	160.00
I.....	155.00
K.....	149.00
L.....	143.00

"M. M." finish

No. 7448¹/₄

Die.....2.0 x 0.8 x 5.0..6.8
B.Ba. (S.S.) 2.10 x 1.4 x 0.10..3.2

Weight complete 1850 lbs.

D.....	\$153.00
F.....	147.00
G.....	143.00
H.....	140.00
I.....	137.00
K.....	132.00
L.....	127.00

"M. M." finish

No. 7448¹/₂

Die.....1.10 x 0.6 x 4.10..4.5
B.Ba. (S.S.) 2.8 x 1.0 x 0.10..2.3

Weight complete 1325 lbs.

D.....	\$118.00
F.....	114.00
G.....	112.00
H.....	109.00
I.....	107.00
K.....	104.00
L.....	101.00

"M. M." finish

No. 7449

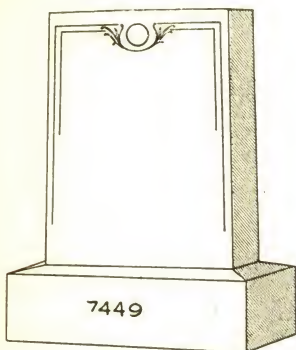

Die.....2.6 x 1. 0 x 3.0 .7.6
 B. Ba. (S.S.) .3.6 x 1.10 x 1.0 .6.5

Weight complete 2475 lbs.

D.....	\$148.00
F.....	140.00
G.....	137.00
H.....	133.00
I.....	129.00
K.....	123.00
L.....	118.00

"M. M." finish

No. 7450

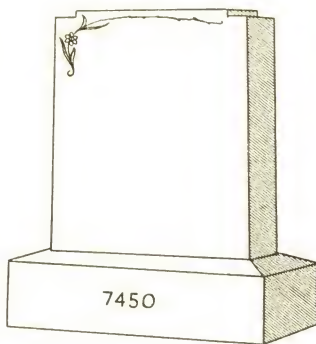

Die.....2.4 x 1. 0 x 3.0 .7.0
 B. Ba. (S.S.) .3.4 x 1.10 x 1.0 .6.1

Weight complete 2300 lbs.

D.....	\$128.00
F.....	122.00
G.....	118.00
H.....	115.00
I.....	111.00
K.....	106.00
L.....	101.00

"M. M." finish

No. 7449¹/₄

Die.....2.6 x 0.10 x 3.0 .6. 3
 B. Ba. (S.S.) .3.6 x 1. 8 x 1.0 .5.10

Weight complete 2150 lbs.

D.....	\$128.00
F.....	122.00
G.....	119.00
H.....	116.00
I.....	113.00
K.....	108.00
L.....	103.00

"M. M." finish

No. 7450¹/₄

Die.....2.4 x 0.10 x 3.0 .5.10
 B. Ba. (S.S.) .3.4 x 1. 8 x 1.0 .5. 7

Weight complete 2025 lbs.

D.....	\$112.00
F.....	106.00
G.....	103.00
H.....	100.00
I.....	97.50
K.....	93.00
L.....	88.50

"M. M." finish

No. 7449¹/₂

Die.....2.6 x 0.8 x 3.0 .5.0
 B. Ba. (S.S.) .3.4 x 1.4 x 1.0 .4.5

Weight complete 1700 lbs.

D.....	\$106.00
F.....	102.00
G.....	99.00
H.....	96.50
I.....	94.00
K.....	90.50
L.....	86.50

"M. M." finish

No. 7450¹/₂

Die.....2.4 x 0.8 x 3.0 .4.8
 B. Ba. (S.S.) .3.2 x 1.4 x 1.0 .4.3

Weight complete 1600 lbs.

D.....	\$91.50
F.....	86.50
G.....	84.50
H.....	82.00
I.....	79.50
K.....	76.00
L.....	72.50

"M. M." finish

No. 7451

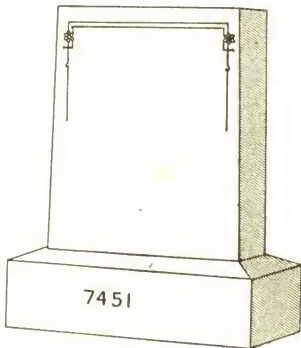

Die.....2.0 x 1.0 x 2.6..5.0
 B. Ba. (S.S.)...2.8 x 1.6 x 1.0..4.0
 Weight complete 1600 lbs.

D.....	\$99.50
F.....	94.50
G.....	92.00
H.....	89.50
I.....	87.00
K.....	83.50
L.....	79.50

"M. M." finish

No. 7451¹/₄

Die.....2.0 x 0.10 x 2.6..4.2
 B. Ba. (S.S.)...2.8 x 1.4 x 1.0..3.7
 Weight complete 1375 lbs.

D.....	\$87.00
F.....	83.00
G.....	81.00
H.....	79.00
I.....	76.50
K.....	73.50
L.....	70.50

"M. M." finish

No. 7451¹/₂

Die.....2.0 x 0.8 x 2.6..3.4
 B. Ba. (S.S.)...2.8 x 1.2 x 1.0..3.1
 Weight complete 1135 lbs.

D.....	\$74.00
F.....	70.50
G.....	68.50
H.....	67.00
I.....	65.50
K.....	63.00
L.....	60.50

"M. M." finish

No. 7451³/₄

Die.....1.8 x 0.6 x 2.4..1.11
 B. Ba. (S.S.)...2.2 x 1.0 x 0.10..1.10
 Weight complete 675 lbs.

D.....	\$49.00
F.....	47.00
G.....	46.00
H.....	45.00
I.....	44.25
K.....	42.75
L.....	41.25

"M. M." finish

No. 7452

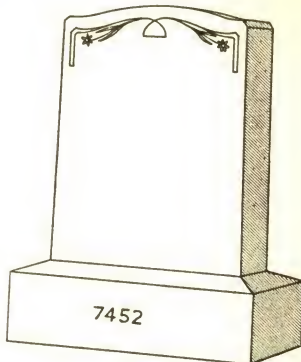

Die.....2.0 x 1.0 x 2.6..5.0
 B. Ba. (S.S.)...2.8 x 1.6 x 1.0..4.0
 Weight complete 1600 lbs.

D.....	\$93.50
F.....	88.50
G.....	86.00
H.....	83.50
I.....	81.00
K.....	77.50
L.....	73.50

"M. M." finish

No. 7452¹/₄

Die.....2.0 x 0.10 x 2.6..4.2
 B. Ba. (S.S.)...2.8 x 1.4 x 1.0..3.7
 Weight complete 1375 lbs.

D.....	\$81.00
F.....	77.00
G.....	75.00
H.....	73.00
I.....	70.50
K.....	67.50
L.....	64.50

"M. M." finish

No. 7452¹/₂

Die.....2.0 x 0.8 x 2.6..3.4
 B. Ba. (S.S.)...2.8 x 1.2 x 1.0..3.1
 Weight complete 1135 lbs.

D.....	\$67.50
F.....	64.50
G.....	62.50
H.....	61.00
I.....	59.50
K.....	57.00
L.....	54.50

"M. M." finish

No. 7452³/₄

Die.....1.8 x 0.6 x 2.4..1.11
 B. Ba. (S.S.)...2.2 x 1.0 x 0.10..1.10
 Weight complete 675 lbs.

D.....	\$43.00
F.....	41.00
G.....	40.00
H.....	39.00
I.....	38.25
K.....	36.75
L.....	35.25

"M. M." finish

No. 7453

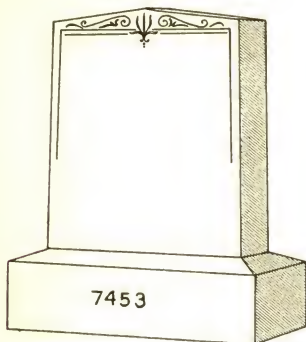

Die.....2.0 x 1.0 x 2.6..5.0
 B. Ba. (S.S.)...2.8 x 1.6 x 1.0..4.0
 Weight complete 1600 lbs.

D.....	\$93.50
F.....	88.50
G.....	86.00
H.....	83.50
I.....	81.00
K.....	77.50
L.....	73.50

"M. M." finish

No. 7453¹/₄

Die.....2.0 x 0.10 x 2.6..4.2
 B. Ba. (S.S.)..2.8 x 1.4 x 1.0..3.7
 Weight complete 1375 lbs.

D.....	\$81.00
F.....	77.00
G.....	75.00
H.....	73.00
I.....	70.50
K.....	67.50
L.....	64.50

"M. M." finish

No. 7453¹/₂

Die.....2.0 x 0.8 x 2.6..3.4
 B. Ba. (S.S.)..2.8 x 1.2 x 1.0..3.1
 Weight complete 1135 lbs.

D.....	\$67.50
F.....	64.50
G.....	62.50
H.....	61.00
I.....	59.50
K.....	57.00
L.....	54.50

"M. M." finish

No. 7453³/₄

Die.....1.8 x 0.6 x 2.4..1.11
 B. Ba. (S.S.)..2.2 x 1.0 x 0.10..1.10
 Weight complete 675 lbs.

D.....	\$43.00
F.....	41.00
G.....	40.00
H.....	39.00
I.....	38.25
K.....	36.25
L.....	35.25

"M. M." finish

No. 7454

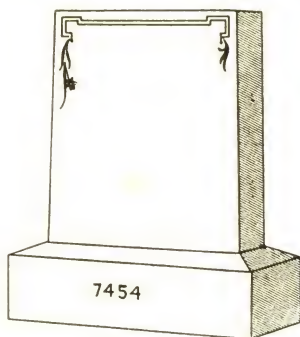

Die.....2.4 x 1.0 x 3.0..7.0
 B. Ba. (S.S.)..3.4 x 1.10 x 1.0..6.1
 Weight complete 2300 lbs.

D.....	\$131.00
F.....	125.00
G.....	121.00
H.....	118.00
I.....	114.00
K.....	109.00
L.....	104.00

"M. M." finish

No. 7454¹/₄

Die.....2.4 x 0.10 x 3.0..5.10
 B. Ba. (S.S.)..3.4 x 1.8 x 1.0..5.7
 Weight complete 2025 lbs.

D.....	\$115.00
F.....	109.00
G.....	106.00
H.....	103.00
I.....	100.00
K.....	96.00
L.....	92.00

"M. M." finish

No. 7454¹/₂

Die.....2.4 x 0.8 x 3.0..4.8
 B. Ba. (S.S.)..3.2 x 1.4 x 1.0..4.3
 Weight complete 1600 lbs.

D.....	\$94.50
F.....	89.50
G.....	87.50
H.....	85.00
I.....	82.50
K.....	79.00
L.....	75.50

"M. M." finish

No. 7455

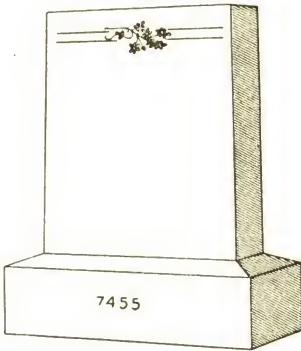

Die..... 2.0 x 1.0 x 2.6 . . 5.0
 B. Ba. (S.S.) . . 2.8 x 1.6 x 1.0 . . 4.0
 Weight complete 1600 lbs.

D.....	\$90.50
F.....	85.50
G.....	83.00
H.....	80.50
I.....	78.00
K.....	74.50
L.....	70.50

"M. M." finish

No. 7455¹/₄

Die..... 2.0 x 0.10 x 2.6 . . 4.2
 B. Ba. (S.S.) . . 2.8 x 1.4 x 1.0 . . 3.7
 Weight complete 1375 lbs.

D.....	\$78.00
F.....	74.00
G.....	72.00
H.....	70.00
I.....	67.50
K.....	64.50
L.....	61.50

"M. M." finish

No. 7455¹/₂

Die..... 2.0 x 0.8 x 2.6 . . 3.4
 B. Ba. (S.S.) . . 2.8 x 1.2 x 1.0 . . 3.1
 Weight complete 1135 lbs.

D.....	\$65.00
F.....	62.00
G.....	60.00
H.....	58.50
I.....	57.00
K.....	54.50
L.....	52.00

"M. M." finish

No. 7455³/₄

Die..... 1.8 x 0.6 x 2.4 . . 1.11
 B. Ba. (S.S.) . . 2.2 x 1.0 x 0.10 . . 1.10
 Weight complete 675 lbs.

D.....	\$41.25
F.....	39.25
G.....	38.25
H.....	37.25
I.....	36.50
K.....	35.00
L.....	33.50

"M. M." finish

No. 7456

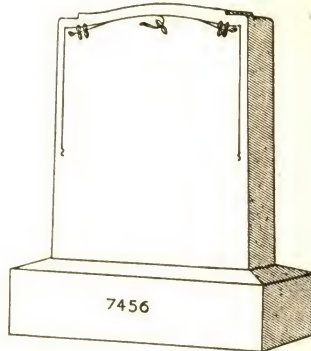

Die..... 2.0 x 1.0 x 2.6 . . 5.0
 B. Ba. (S.S.) . . 2.8 x 1.6 x 1.0 . . 4.0
 Weight complete 1600 lbs.

D.....	\$102.00
F.....	96.50
G.....	94.00
H.....	91.50
I.....	89.00
K.....	85.50
L.....	81.50

"M. M." finish

No. 7456¹/₄

Die..... 2.0 x 0.10 x 2.6 . . 4.2
 B. Ba. (S.S.) . . 2.8 x 1.4 x 1.0 . . 3.7
 Weight complete 1375 lbs.

D.....	\$88.00
F.....	84.00
G.....	82.00
H.....	80.00
I.....	77.50
K.....	74.50
L.....	71.50

"M. M." finish

No. 7456¹/₂

Die..... 2.0 x 0.8 x 2.6 . . 3.4
 B. Ba. (S.S.) . . 2.8 x 1.2 x 1.0 . . 3.1
 Weight complete 1135 lbs.

D.....	\$74.50
F.....	71.50
G.....	69.50
H.....	68.00
I.....	66.50
K.....	64.00
L.....	61.50

"M. M." finish

No. 7456³/₄

Die..... 1.8 x 0.6 x 2.4 . . 1.11
 B. Ba. (S.S.) . . 2.2 x 1.0 x 0.10 . . 1.10
 Weight complete 675 lbs.

D.....	\$50.00
F.....	48.00
G.....	47.00
H.....	46.00
I.....	45.25
K.....	43.75
L.....	42.25

"M. M." finish

No. 7457

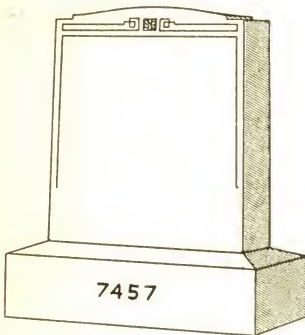

Die.....2.6 x 1. 0 x 3.0 . . 7.6
 B. Ba. (S.S.) . . 3.6 x 1.10 x 1.0 . . 6.5
 Weight complete 2475 lbs.

D.....	\$150.00
F.....	142.00
G.....	139.00
H.....	135.00
I.....	131.00
K.....	125.00
L.....	120.00

"M. M." finish

No. 7458

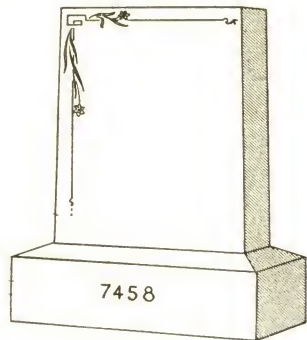

Die.....2.6 x 1. 0 x 3.0 . . 7.6
 B. Ba. (S.S.) . . 3.6 x 1.10 x 1.0 . . 6.5
 Weight complete 2475 lbs.

D.....	\$144.00
F.....	136.00
G.....	133.00
H.....	129.00
I.....	125.00
K.....	119.00
L.....	114.00

"M. M." finish

No. 7457¹/₄

Die.....2.6 x 0.10 x 3.0 . . 6. 3
 B. Ba. (S.S.) . . 3.6 x 1. 8 x 1.0 . . 5.10
 Weight complete 2150 lbs.

D.....	\$130.00
F.....	124.00
G.....	121.00
H.....	118.00
I.....	115.00
K.....	110.00
L.....	105.00

"M. M." finish

No. 7458¹/₄

Die.....2.6 x 0.10 x 3.0 . . 6. 3
 B. Ba. (S.S.) . . 3.6 x 1. 8 x 1.0 . . 5.10
 Weight complete 2300 lbs.

D.....	\$124.00
F.....	118.00
G.....	115.00
H.....	112.00
I.....	109.00
K.....	104.00
L.....	99.00

"M. M." finish

No. 7457¹/₂

Die.....2.6 x 0.8 x 3.0 . . 5.0
 B. Ba. (S.S.) . . 3.4 x 1.4 x 1.0 . . 4.5
 Weight complete 1700 lbs.

D.....	\$106.00
F.....	102.00
G.....	99.00
H.....	96.50
I.....	94.00
K.....	90.50
L.....	86.50

"M. M." finish

No. 7458¹/₂

Die.....2.6 x 0.8 x 3.0 . . 5.0
 B. Ba. (S.S.) . . 3.4 x 1.4 x 1.0 . . 4.5
 Weight complete 1725 lbs.

D.....	\$103.00
F.....	97.50
G.....	95.00
H.....	92.50
I.....	90.00
K.....	86.50
L.....	82.50

"M. M." finish

No. 7459

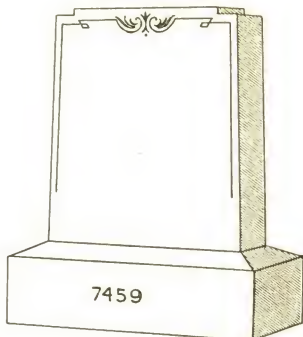

Die.....2.0 x 1.0 x 2.6 . . 5.0
 B. Ba. (S.S.)...2.8 x 1.6 x 1.0 . . 4.0
 Weight complete 1600 lbs.

D.....	\$99.50
F.....	94.50
G.....	92.00
H.....	89.50
I.....	87.00
K.....	83.50
L.....	79.50

"M. M." finish

No. 7459¹/₄

Die.....2.0 x 0.10 x 2.6 . . 4.2
 B. Ba. (S.S.) . . 2.8 x 1.4 x 1.0 . . 3.7
 Weight complete 1375 lbs.

D.....	\$87.00
F.....	83.00
G.....	81.00
H.....	79.00
I.....	76.50
K.....	73.50
L.....	70.50

"M. M." finish

No. 7459¹/₂

Die.....2.0 x 0.8 x 2.6 . . 3.4
 B. Ba. (S.S.) . . 2.8 x 1.2 x 1.0 . . 3.1
 Weight complete 1135 lbs.

D.....	\$73.50
F.....	70.50
G.....	68.50
H.....	67.00
I.....	65.50
K.....	63.00
L.....	60.50

"M. M." finish

No. 7459³/₄

Die.....1.8 x 0.6 x 2.4 . . 1.11
 B. Ba. (S.S.) . . 2.2 x 1.0 x 0.10 . . 1.10
 Weight complete 675 lbs.

D.....	\$49.00
F.....	47.00
G.....	46.00
H.....	45.00
I.....	44.25
K.....	42.75
L.....	41.25

"M. M." finish

No. 7460

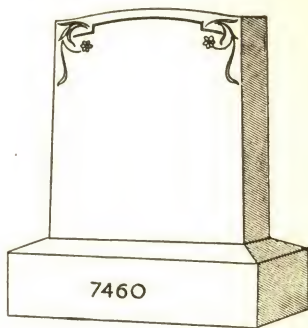

Die.....2.6 x 1.0 x 3.0 . . 7.6
 B. Ba. (S.S.) . . 3.6 x 1.10 x 1.0 . . 6.5
 Weight complete 2475 lbs.

D.....	\$145.00
F.....	137.00
G.....	134.00
H.....	130.00
I.....	126.00
K.....	120.00
L.....	115.00

"M. M." finish

No. 7460¹/₄

Die.....2.6 x 0.10 x 3.0 . . 6.3
 B. Ba. (S.S.) . . 3.6 x 1.8 x 1.0 . . 5.10
 Weight complete 2300 lbs.

D.....	\$125.00
F.....	119.00
G.....	116.00
H.....	113.00
I.....	110.00
K.....	105.00
L.....	100.00

"M. M." finish

No. 7460¹/₂

Die.....2.6 x 0.8 x 3.0 . . 5.0
 B. Ba. (S.S.) . . 3.4 x 1.4 x 1.0 . . 4.5
 Weight complete 1725 lbs.

D.....	\$103.00
F.....	97.50
G.....	95.00
H.....	92.50
I.....	90.00
K.....	86.50
L.....	82.50

"M. M." finish

No. 7461

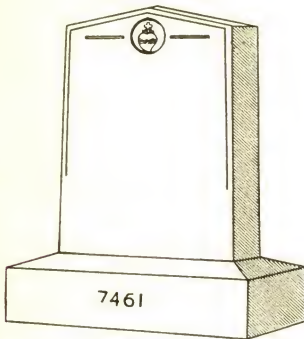

Die.....3.0 x 1. 0 x 4.0..12.0
 B.Ba. (S.S.) 4.0 x 1.10 x 1.0.. 7.4
 Weight complete 3400 lbs.

D.....	\$232.00
F.....	220.00
G.....	214.00
H.....	208.00
I.....	202.00
K.....	193.00
L.....	184.00

"M. M." finish

No. 7461¹/₄

Die.....3.0 x 0.10 x 4.0..10.0
 B.Ba. (S.S.) 4.0 x 1. 8 x 1.0.. 6.8
 Weight complete 2950 lbs.

D.....	\$203.00
F.....	193.00
G.....	188.00
H.....	183.00
I.....	178.00
K.....	171.00
L.....	163.00

"M. M." finish

No. 7461¹/₂

Die.....2.8 x 0.10 x 3.6..7.9
 B. Ba. (S.S.) .3.8 x 1. 6 x 1.0..5.6
 Weight complete 2350 lbs.

D.....	\$167.00
F.....	159.00
G.....	155.00
H.....	151.00
I.....	148.00
K.....	142.00
L.....	136.00

"M. M." finish

No. 7461³/₄

Die.....2.8 x 0.8 x 3.6..6. 3
 B. Ba. (S.S.) .3.8 x 1.4 x 1.0..4.11
 Weight complete 1975 lbs.

D.....	\$144.00
F.....	138.00
G.....	135.00
H.....	132.00
I.....	129.00
K.....	124.00
L.....	119.00

"M. M." finish

No. 7462

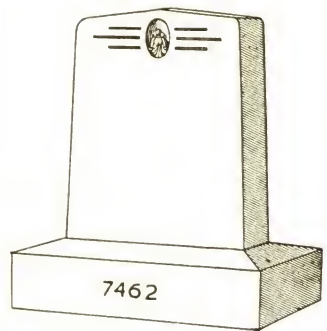

Die.....3.0 x 1. 0 x 4.0..12.0
 B.Ba. (S.S.) 4.0 x 1.10 x 1.0.. 7.4
 Weight complete 3400 lbs.

D.....	\$236.00
F.....	224.00
G.....	218.00
H.....	212.00
I.....	206.00
K.....	197.00
L.....	188.00

"M. M." finish

No. 7462¹/₄

Die.....3.0 x 0.10 x 4.0..10.0
 B.Ba. (S.S.) 4.0 x 1. 8 x 1.0.. 6.8
 Weight complete 2950 lbs.

D.....	\$207.00
F.....	197.00
G.....	192.00
H.....	187.00
I.....	182.00
K.....	175.00
L.....	167.00

"M. M." finish

No. 7462¹/₂

Die.....2.8 x 0.10 x 3.6..7.9
 B. Ba. (S.S.) .3.8 x 1. 6 x 1.0..5.6
 Weight complete 2350 lbs.

D.....	\$170.00
F.....	162.00
G.....	158.00
H.....	154.00
I.....	151.00
K.....	145.00
L.....	139.00

"M. M." finish

No. 7462³/₄

Die.....2.8 x 0.8 x 3.6..6. 3
 B. Ba. (S.S.) .3.8 x 1.4 x 1.0..4.11
 Weight complete 1975 lbs.

D.....	\$147.00
F.....	141.00
G.....	138.00
H.....	135.00
I.....	132.00
K.....	127.00
L.....	122.00

"M. M." finish

No. 7463

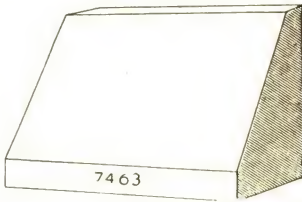

Die.....2.2 x 1.0 x 1.8..3.7

Weight complete 600 lbs.

D.....	\$46.75
F.....	43.25
G.....	41.50
H.....	39.50
I.....	37.75
K.....	35.25
L.....	32.50

"M. M." finish

No. 7463—A

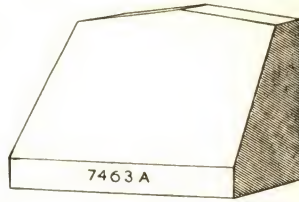

Die.....2.2 x 1.0 x 1.8..3.7

Weight complete 600 lbs.

D.....	\$48.75
F.....	45.25
G.....	43.50
H.....	41.75
I.....	39.75
K.....	37.25
L.....	34.50

"M. M." finish

No. 7463¹/₄

Die.....2.0 x 0.10 x 1.6..2.6

Weight complete 425 lbs.

D.....	\$34.25
F.....	31.75
G.....	30.50
H.....	29.25
I.....	28.00
K.....	26.25
L.....	24.25

"M. M." finish

No. 7463¹/₄—A

Die.....2.0 x 0.10 x 1.6..2.6

Weight complete 425 lbs.

D.....	\$35.25
F.....	32.75
G.....	31.50
H.....	30.25
I.....	29.00
K.....	27.25
L.....	25.25

"M. M." finish

No. 7463¹/₂

Die.....1.10 x 0.8 x 1.4..1.8

Weight complete 275 lbs.

D.....	\$23.75
F.....	22.25
G.....	21.25
H.....	20.50
I.....	19.75
K.....	18.50
L.....	17.25

"M. M." finish

No. 7463¹/₂—A

Die.....1.10 x 0.8 x 1.4..1.8

Weight complete 275 lbs.

D.....	\$24.75
F.....	23.25
G.....	22.25
H.....	21.50
I.....	20.75
K.....	19.50
L.....	18.25

"M. M." finish

No. 7463—B

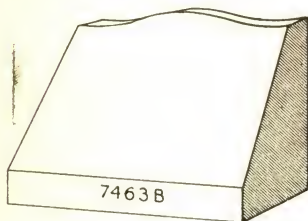

Die.....2.2 x 1.0 x 1.8..3.7

Weight complete 600 lbs.

D.....	\$48.75
F.....	45.25
G.....	43.50
H.....	41.75
I.....	39.75
K.....	37.25
L.....	34.50

"M. M." finish

No. 7463¹/₄—B

Die.....2.0 x 0.10 x 1.6..2.6

Weight complete 425 lbs.

D.....	\$35.25
F.....	32.75
G.....	31.50
H.....	30.25
I.....	29.00
K.....	27.25
L.....	25.25

"M. M." finish

No. 7463¹/₂—B

Die.....1.10 x 0.8 x 1.4..1.8

Weight complete 275 lbs.

D.....	\$24.75
F.....	23.25
G.....	22.25
H.....	21.50
I.....	20.75
K.....	19.50
L.....	18.25

"M. M." finish

No. 7464

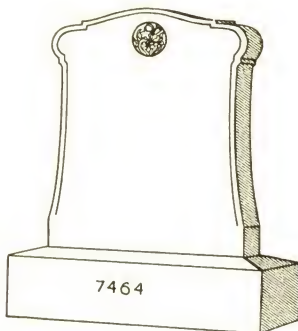

Die.....2.10 x 1.0 x 3.4..9.5

B. Ba. (S.S.)..3. 8 x 1.8 x 1.0..6.1

Weight complete 2700 lbs.

D.....	\$199.00
F.....	191.00
G.....	186.00
H.....	181.00
I.....	176.00
K.....	169.00
L.....	162.00

"M. M." finish

No. 7464¹/₄

Die.....2.10 x 0.10 x 3.4..7.10

B. Ba. (S.S.)..3. 8 x 1.6 x 1.0..5.6

Weight complete 2300 lbs.

D.....	\$174.00
F.....	166.00
G.....	162.00
H.....	158.00
I.....	154.00
K.....	148.00
L.....	143.00

"M. M." finish

No. 7464¹/₂

Die.....2.10 x 0.8 x 3.4..6.4

B. Ba. (S.S.)..3. 8 x 1.4 x 1.0..4.11

Weight complete 1950 lbs.

D.....	\$148.00
F.....	142.00
G.....	139.00
H.....	136.00
I.....	132.00
K.....	128.00
L.....	123.00

"M. M." finish

No. 7465

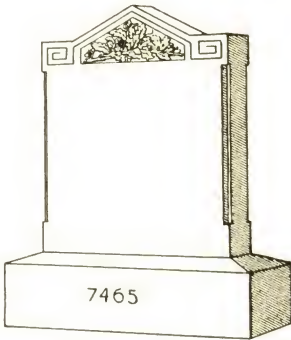

Die.....2.6 x 1.0 x 3.4..8.4
 B. Ba. (S.S.)...3.4 x 1.8 x 1.0..5.7

Weight complete 2400 lbs.

D.....	\$187.00
F.....	179.00
G.....	175.00
H.....	171.00
I.....	166.00
K.....	160.00
L.....	154.00

"M. M." finish

No. 7466

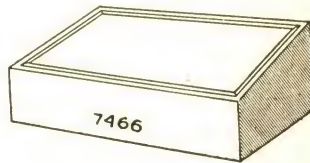

Die.....2.0 x 1.2 x 1.0..2.4

Weight complete 400 lbs.

D.....	\$36.00
F.....	34.00
G.....	32.75
H.....	31.50
I.....	30.25
K.....	28.50
L.....	26.75

"M. M." finish

No. 7465¹/₄

Die.....2.6 x 0.10 x 3.4..6.11
 B. Ba. (S.S.) 3.4 x 1.6 x 1.0..5.0

Weight complete 2050 lbs.

D.....	\$167.00
F.....	161.00
G.....	157.00
H.....	154.00
I.....	150.00
K.....	145.00
L.....	140.00

"M. M." finish

No. 7466¹/₄

Die.....1.10 x 1.2 x 0.10..1.9

Weight complete 300 lbs.

D.....	\$28.00
F.....	26.00
G.....	25.25
H.....	24.25
I.....	23.50
K.....	22.25
L.....	20.75

"M. M." finish

No. 7465¹/₂

Die.....2.6 x 0.8 x 3.4..5.7
 B. Ba. (S.S.)...3.4 x 1.4 x 1.0..4.5

Weight complete 1725 lbs.

D.....	\$150.00
F.....	144.00
G.....	141.00
H.....	139.00
I.....	136.00
K.....	132.00
L.....	127.00

"M. M." finish

No. 7466¹/₂

Die.....1.8 x 1.2 x 0.10..1.7

Weight complete 275 lbs.

D.....	\$24.75
F.....	23.25
G.....	22.50
H.....	21.50
I.....	20.75
K.....	19.75
L.....	18.50

"M. M." finish

No. 7467

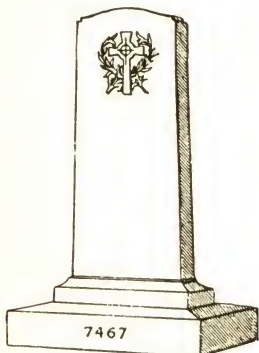

Die.....2.0 x 0.10 x 5.0..8.4
 Base.....2.4 x 1.2 x 0.6..1.4
 B.Ba. (S.S.)..3.4 x 2.2 x 0.10..6.0

Weight complete 2700 lbs.

D.....	\$234.00
F.....	224.00
G.....	219.00
H.....	215.00
I.....	210.00
K.....	202.00
L.....	195.00

"M. M." finish

No. 7468

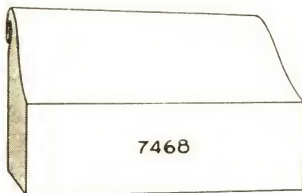

Die.....2.4 x 1.2 x 1.6..4.1

Weight complete 725 lbs.

D.....	\$70.00
F.....	66.00
G.....	64.00
H.....	62.00
I.....	60.00
K.....	57.00
L.....	53.50

"M. M." finish

No. 7468¹/₄

Die.....2.2 x 1.0 x 1.4..2.11

Weight complete 525 lbs.

D.....	\$55.50
F.....	52.50
G.....	51.00
H.....	49.50
I.....	48.25
K.....	46.00
L.....	43.75

"M. M." finish

No. 7467¹/₄

Die.....2.0 x 0.8 x 5.0..6.8
 Base.....2.4 x 1.0 x 0.6..1.2
 B. Ba. (S.S.)..3.4 x 2.0 x 0.8..4.5

Weight complete 2100 lbs.

D.....	\$201.00
F.....	193.00
G.....	189.00
H.....	185.00
I.....	181.00
K.....	175.00
L.....	170.00

"M. M." finish

No. 7468¹/₂

Die.....2.0 x 0.10 x 1.2..1.11

Weight complete 330 lbs.

D.....	\$43.00
F.....	41.00
G.....	40.00
H.....	39.00
I.....	38.25
K.....	36.75
L.....	35.25

"M. M." finish

No. 7469

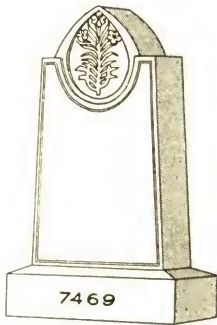

Die.....2.6 x 1.0 x 4.6...11.3
 B. Ba. (S.S.) .3.6 x 1.10 x 1.0... 6.5

Weight complete 3100 lbs.

D.....	\$248.00
F.....	236.00
G.....	231.00
H.....	225.00
I.....	220.00
K.....	211.00
L.....	203.00

"M. M." finish

No. 7469¹/₄

Die.....2.4 x 0.10 x 4.2...8.1
 B. Ba. (S.S.) .3.4 x 1.8 x 1.0...5.7

Weight complete 2400 lbs.

D.....	\$204.00
F.....	196.00
G.....	192.00
H.....	188.00
I.....	184.00
K.....	178.00
L.....	172.00

"M. M." finish

No. 7469¹/₂

Die.....2.0 x 0.8 3.10...5.1
 B. Ba. (S.S.) .2.10 x 1.4 x 1.0...3.9

Weight complete 1550 lbs.

D.....	\$156.00
F.....	150.00
G.....	148.00
H.....	145.00
I.....	143.00
K.....	139.00
L.....	135.00

"M. M." finish

No. 7470

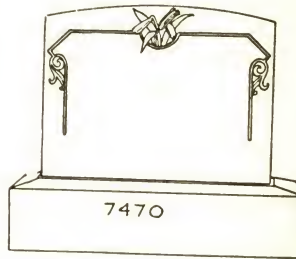

Die.....1.6 x 0.4 x 1.2...0.7
 B. Base.....1.10 x 0.8 x 0.6...0.7

Weight complete 210 lbs.; no B. B. 100 lbs.

D.....	\$14.25
F.....	13.75
G.....	13.50
H.....	13.00
I.....	12.75
K.....	12.50
L.....	12.00

If B. B. is omitted deduct \$2.20

No. 7470¹/₄

Die.....1.4 x 0.4 x 1.0...0.5
 B. Base.....1.8 x 0.8 x 0.6...0.7

Weight complete 180 lbs.; no B. B. 75 lbs.

D.....	\$11.75
F.....	11.50
G.....	11.25
H.....	11.00
I.....	10.75
K.....	10.25
L.....	10.00

If B. B. is omitted deduct \$2.20

No. 7470—A

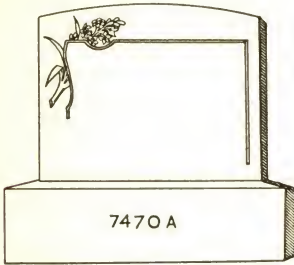

Sizes and prices same as No. 7470.

No. 7470—C

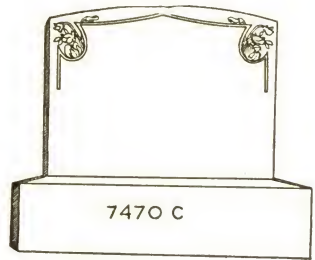

Sizes and prices same as No. 7470.

No. 7470—D

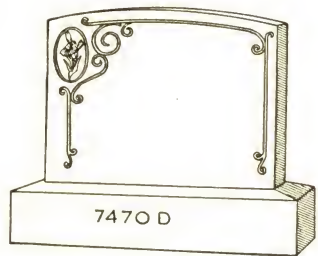

Sizes and prices same as No. 7470.

No. 7470—B

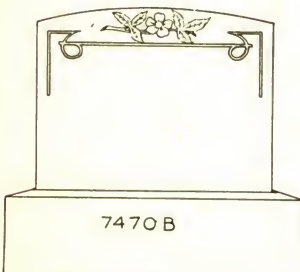

Sizes and prices same as No. 7470.

No. 7470—E

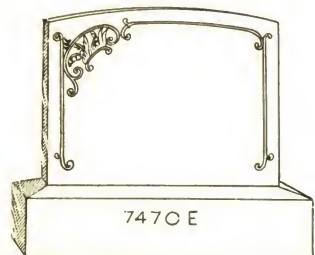

Sizes and prices same as No. 7470.

No. 7471

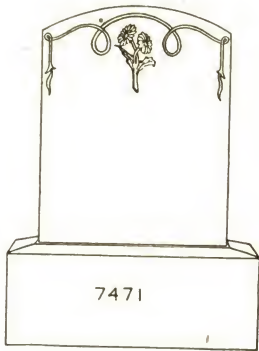

Die.....1.2 x 0.4 x 1.6..0.7
 B. Base.....1.6 x 0.8 x 0.8..0.8
 Weight complete 225 lbs.; no B. B. 105 lbs.
 D.....\$14.25
 F.....13.75
 G.....13.50
 H.....13.00
 I.....12.75
 K.....12.50
 L.....12.00
 If B. B. is omitted deduct \$2.50

No. 7471¹/₄

Die.....1.0 x 0.4 x 1.4..0.5
 B. Base.....1.4 x 0.8 x 0.8..0.7
 Weight complete 180 lbs.; no B. B. 75 lbs.
 D.....\$11.75
 F.....11.50
 G.....11.25
 H.....11.00
 I.....10.75
 K.....10.25
 L.....10.00
 If B. B. is omitted deduct \$2.20

No. 7471—A

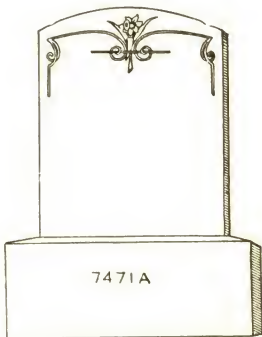

Sizes and prices same as No. 7471.

No. 7471—B

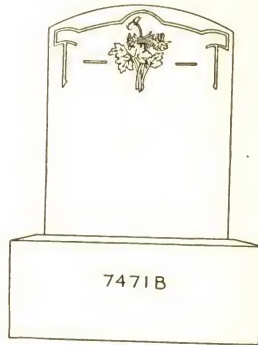

Sizes and prices same as No. 7471.

No. 7471—C

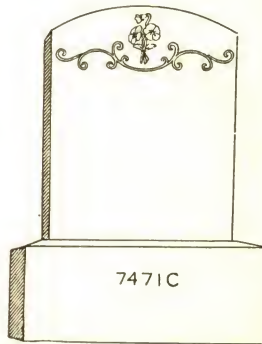

Sizes and prices same as No. 7471.

No. 7473

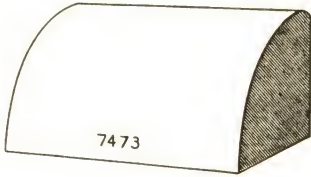

Die.....2.2 x 1.2 x 1.2 . . 2.11

Weight complete 525 lbs.

D.....	\$39.50
F.....	36.50
G.....	35.00
H.....	33.75
I.....	32.25
K.....	30.00
L.....	27.75

"M. M." finish

No. 7474

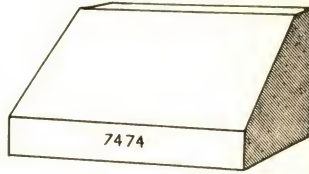

Die.....2.2 x 1.2 x 1.0 . . 2.6

Weight complete 400 lbs.

D.....	\$33.25
F.....	30.75
G.....	29.50
H.....	28.25
I.....	27.00
K.....	25.25
L.....	23.25

"M. M." finish

No. 7473¹/₄

Die.....2.0 x 1.0 x 1.0 . . 2.0

Weight complete 325 lbs.

D.....	\$29.00
F.....	27.00
G.....	26.00
H.....	25.00
I.....	24.00
K.....	22.50
L.....	21.00

"M. M." finish

No. 7474¹/₄

Die.....2.0 x 1.0 x 1.0 . . 2.0

Weight complete 325 lbs.

D.....	\$27.00
F.....	25.00
G.....	24.00
H.....	23.00
I.....	22.00
K.....	20.50
L.....	19.00

"M. M." finish

No. 7473¹/₂

Die.....1.10 x 0.10 x 0.10 . . 1.3

Weight complete 200 lbs.

D.....	\$20.50
F.....	19.50
G.....	18.75
H.....	18.25
I.....	17.50
K.....	16.50
L.....	15.75

"M. M." finish

No. 7474¹/₂

Die.....1.10 x 0.10 x 0.10 . . 1.3

Weight complete 200 lbs.

D.....	\$18.50
F.....	17.50
G.....	16.75
H.....	16.25
I.....	15.50
K.....	14.50
L.....	13.75

"M. M." finish

No. 7475

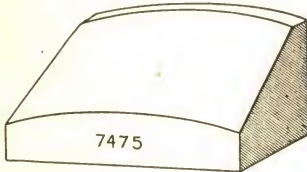

Die.....2.2 x 1.2 x 1.0..2.6
Weight complete 400 lbs.

D.....	\$36.25
F.....	33.75
G.....	32.50
H.....	31.25
I.....	30.00
K.....	28.25
L.....	26.25

"M. M." finish

No. 7475¹/₄

Die.....2.0 x 1.0 x 1.0..2.0
Weight complete 325 lbs.

D.....	\$29.00
F.....	27.00
G.....	26.00
H.....	25.00
I.....	24.00
K.....	22.50
L.....	21.00

"M. M." finish

No. 7475¹/₂

Die.....1.10 x 0.10 x 0.10..1.3
Weight complete 200 lbs.

D.....	\$20.50
F.....	19.50
G.....	18.75
H.....	18.25
I.....	17.50
K.....	16.50
L.....	15.75

"M. M." finish

No. 7476

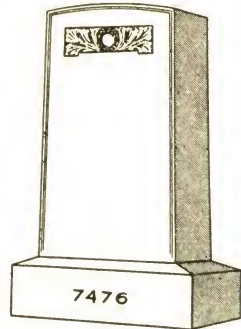

Die.....2.4 x 1.0 x 4.0..9.4
B. Ba. (S.S.)..3.4 x 1.10 x 1.0..6.1
Weight complete 2700 lbs.

D.....	\$198.00
F.....	188.00
G.....	184.00
H.....	179.00
I.....	174.00
K.....	167.00
L.....	160.00

"M. M." finish

No. 7476¹/₄

Die.....2.2 x 0.10 x 3.8..6.7
B. Ba. (S.S.)..3.2 x 1.8 x 1.0..5.3
Weight complete 2100 lbs.

D.....	\$164.00
F.....	158.00
G.....	154.00
H.....	151.00
I.....	148.00
K.....	143.00
L.....	138.00

"M. M." finish

No. 7476¹/₂

Die.....2.0 x 0.8 x 3.6..4.8
B. Ba. (S.S.)..2.10 x 1.4 x 1.0..3.9
Weight complete 1500 lbs.

D.....	\$129.00
F.....	125.00
G.....	122.00
H.....	120.00
I.....	118.00
K.....	114.00
L.....	111.00

"M. M." finish

No. 7476³/₄

Die.....1.10 x 0.6 x 3.2..2.11
B. Ba. (S.S.)..2.6 x 1.0 x 0.10..2.1
Weight complete 900 lbs.

D.....	\$97.50
F.....	94.50
G.....	93.00
H.....	91.50
I.....	90.00
K.....	88.00
L.....	86.00

"M. M." finish

No. 7477

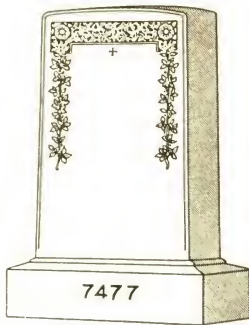

Die.....2.8 x 1. 0 x 4.2...11.1
 B.Ba. (S.S.)..3.8 x 1.10 x 1.0.. 6.9

Weight complete 3200 lbs.

D.....	\$281.00
F.....	269.00
G.....	264.00
H.....	258.00
I.....	253.00
K.....	245.00
L.....	236.00

"M. M." finish

No. 7478

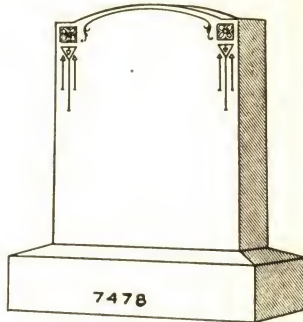

Die.....2.6 x 1.0 x 3.6..8.9
 B. Ba. (S.S.)..3.4 x 1.8 x 1.0..5.7

Weight complete 2400 lbs.

D.....	\$156.00
F.....	148.00
G.....	143.00
H.....	139.00
I.....	135.00
K.....	128.00
L.....	121.00

"M. M." finish

No. 7477¹/₄

Die.....2.6 x 0.10 x 4.0..8.4
 B.Ba. (S.S.)..3.6 x 1. 8 x 1.0..5.10

Weight complete 2475 lbs.

D.....	\$239.00
F.....	231.00
G.....	227.00
H.....	223.00
I.....	218.00
K.....	212.00
L.....	206.00

"M. M." finish

No. 7478¹/₄

Die.....2.6 x 0.10 x 3.6..7.4
 B. Ba. (S.S.)..3.4 x 1. 6 x 1.0..5.0

Weight complete 2100 lbs.

D.....	\$136.00
F.....	128.00
G.....	125.00
H.....	121.00
I.....	117.00
K.....	112.00
L.....	106.00

"M. M." finish

No. 7477¹/₂

Die.....2.6 x 0.8 x 4.0..6.8
 B. Ba. (S.S.)..3.4 x 1.4 x 1.0..4.5

Weight complete 1900 lbs.

D.....	\$213.00
F.....	207.00
G.....	203.00
H.....	200.00
I.....	197.00
K.....	192.00
L.....	187.00

"M. M." finish

No. 7478¹/₂

Die.....2.6 x 0.8 x 3.6..5.10
 B. Ba. (S.S.)..3.4 x 1.4 x 1.0..4. 5

Weight complete 1775 lbs.

D.....	\$115.00
F.....	109.00
G.....	106.00
H.....	103.00
I.....	100.00
K.....	96.00
L.....	92.00

"M. M." finish

No. 7479

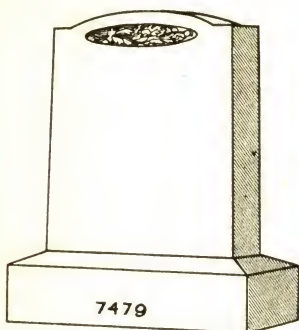

Die.....2.6 x 1.0 x 2.8..6.8
 B. Ba. (S.S.)..3.4 x 1.8 x 1.0..5.7

Weight complete 2000 lbs.

D.....	\$149.00
F.....	143.00
G.....	139.00
H.....	136.00
I.....	133.00
K.....	128.00
L.....	123.00

"M. M." finish

No. 7479¹/₄

Die.....2.4 x 0.10 x 2.6..4.10
 B. Ba. (S.S.)..3.2 x 1.6 x 1.0..4.9

Weight complete 1525 lbs.

D.....	\$117.00
F.....	113.00
G.....	110.00
H.....	108.00
I.....	105.00
K.....	102.00
L.....	98.00

"M. M." finish

No. 7479¹/₂

Die.....2.4 x 0.8 x 2.6..3.11
 B. Ba. (S.S.)..3.2 x 1.4 x 1.0..4.3

Weight complete 1350 lbs.

D.....	\$104.00
F.....	100.00
G.....	98.00
H.....	96.00
I.....	94.00
K.....	91.00
L.....	88.00

"M. M." finish

No. 7480

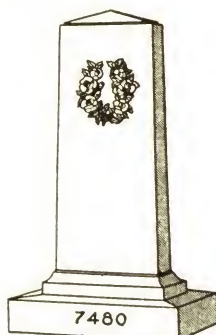

Die.....2.4 x 1.0 x 5.0..11.8
 Base.....2.8 x 1.4 x 0.8..2.4
 B. Ba. (S.S.)..3.8 x 2.4 x 0.10..7.2

Weight complete 2600 lbs.

C.....	\$360.00
D.....	328.00
F.....	314.00
G.....	307.00
H.....	300.00
I.....	293.00
K.....	282.00
L.....	271.00

"M. M." finish

No. 7480¹/₄

Die.....2.0 x 0.10 x 4.10..8.1
 Base.....2.4 x 1.2 x 0.6..1.4
 B. Ba. (S.S.)..3.4 x 2.2 x 0.8..4.10

Weight complete 1700 lbs.

C.....	\$281.00
D.....	260.00
F.....	251.00
G.....	246.00
H.....	241.00
I.....	236.00
K.....	229.00
L.....	222.00

"M. M." finish

No. 7480¹/₂

Die.....2.0 x 0.8 x 4.10..6.5
 Base.....2.4 x 1.0 x 0.6..1.2
 B. Ba. (S.S.)..3.4 x 2.0 x 0.8..4.5

Weight complete 1500 lbs.

C.....	\$252.00
D.....	235.00
F.....	227.00
G.....	223.00
H.....	219.00
I.....	215.00
K.....	209.00
L.....	203.00

"M. M." finish

No. 7481



Die.....2.0 x 1.0 x 6.0..12.0
 Base.....2.5 x 1.5 x 0.8.. 2.3
 B. Ba. (S.S.) .3.8 x 2.8 x 1.0.. 9.9
 Weight complete 4100 lbs.

D.....\$407.00
 F..... 393.00
 G..... 386.00
 H..... 379.00
 I..... 372.00
 K..... 361.00
 L..... 350.00
 "M. M." finish

No. 7481¹/₄

Die.....1.8 x 0.10 x 5.0..6.11
 Base.....2.0 x 1.2 x 0.6..1.2
 B. Ba. (S.S.) .3.0 x 2.2 x 0.10.. .5.5
 Weight complete 2300 lbs.

D.....\$294.00
 F..... 286.00
 G..... 282.00
 H..... 278.00
 I..... 274.00
 K..... 268.00
 L..... 262.00
 "M. M." finish

No. 7481¹/₂

Die.....1.8 x 0.8 x 5.0..5.7
 Base.....2.0 x 1.0 x 0.6..1.0
 B. Ba. (S.S.) .3.0 x 2.0 x 0.10.. .5.0
 Weight complete 1975 lbs.

D.....\$271.00
 F..... 265.00
 G..... 261.00
 H..... 258.00
 I..... 255.00
 K..... 250.00
 L..... 245.00
 "M. M." finish

No. 7482

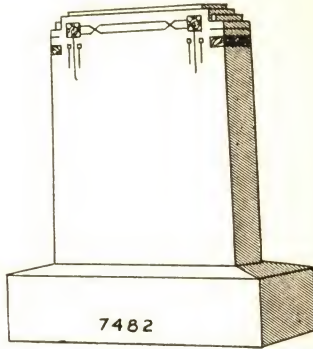

Die.....2.6 x 1.0 x 4.0..10.0
 B. Ba. (S.S.) .3.6 x 1.10 x 1.0.. 6.5
 Weight complete 2800 lbs.

D.....\$239.00
 F..... 229.00
 G..... 224.00
 H..... 219.00
 I..... 214.00
 K..... 207.00
 L..... 199.00
 "M. M." finish

No. 7482¹/₄

Die.....2.6 x 0.10 x 4.0..8.4
 B. Ba. (S.S.) .3.6 x 1.8 x 1.0..5.10
 Weight complete 2400 lbs.

D.....\$207.00
 F..... 199.00
 G..... 195.00
 H..... 191.00
 I..... 186.00
 K..... 180.00
 L..... 174.00
 "M. M." finish

No. 7482¹/₂

Die.....2.6 x 0.8 x 4.0..6.8
 B. Ba. (S.S.) .3.6 x 1.4 x 1.0..4.8
 Weight complete 1950 lbs.

D.....\$172.00
 F..... 166.00
 G..... 162.00
 H..... 159.00
 I..... 156.00
 K..... 151.00
 L..... 146.00
 "M. M." finish

No. 7483

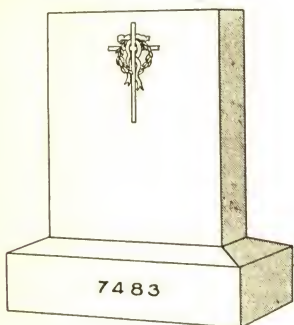

Die.....2.4 x 1. 0 x 3.0..7.0
 B. Ba. (S.S.)..3.4 x 1.10 x 1.0..6.1

Weight complete 2325 lbs.

D.....	\$137.00
F.....	131.00
G.....	127.00
H.....	124.00
I.....	120.00
K.....	115.00
L.....	110.00

"M. M." finish

No. 7483 $\frac{1}{4}$

Die.....2.4 x 0.10 x 3.0..5.10
 B.Ba. (S.S.)..3.4 x 1. 8 x 1.0..5. 7

Weight complete 2025 lbs.

D.....	\$121.00
F.....	115.00
G.....	112.00
H.....	109.00
I.....	106.00
K.....	102.00
L.....	97.50

"M. M." finish

No. 7483 $\frac{1}{2}$

Die.....2.4 x 0.8 x 3.0..4.8
 B. Ba. (S.S.)..3.2 x 1.4 x 1.0..4.3

Weight complete 1575 lbs.

D.....	\$101.00
F.....	95.50
G.....	93.50
H.....	91.00
I.....	88.50
K.....	85.00
L.....	81.50

"M. M." finish

No. 7484

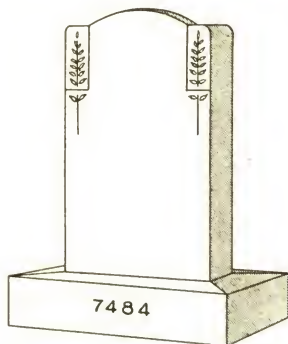

Die.....2.2 x 0.10 x 3.8..6.7
 B. Ba. (S.S.)..3.2 x 1. 8 x 1.0..5.3

Weight complete 2100 lbs.

D.....	\$134.00
F.....	128.00
G.....	124.00
H.....	121.00
I.....	118.00
K.....	113.00
L.....	108.00

"M. M." finish

No. 7484 $\frac{1}{4}$

Die.....2. 0 x 0.8 x 3.6..4.8
 B. Ba. (S.S.)..2.10 x 1.4 x 1.0..3.9

Weight complete 1500 lbs.

D.....	\$102.00
F.....	96.50
G.....	94.50
H.....	92.00
I.....	89.50
K.....	86.00
L.....	82.50

"M. M." finish

No. 7484 $\frac{1}{2}$

Die.....1.10 x 0.6 x 3. 4..3.1
 B.Ba. (S.S.)..2. 6 x 1.0 x 0.10..2.1

Weight complete 900 lbs.

D.....	\$70.50
F.....	67.50
G.....	66.00
H.....	64.50
I.....	63.00
K.....	60.50
L.....	58.00

"M. M." finish

No. 7484 $\frac{3}{4}$

Die.....1.8 x 0.6 x 3. 0..2. 6
 B.Ba. (S.S.)..2.4 x 1.0 x 0.10..1.11

Weight complete 700 lbs.

D.....	\$59.00
F.....	57.00
G.....	55.50
H.....	54.50
I.....	53.00
K.....	51.00
L.....	49.25

"M. M." finish

No. 7485

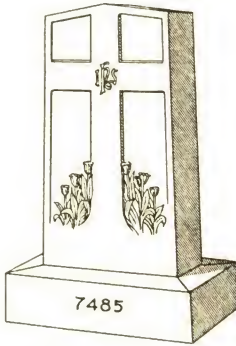

Die.....2.4 x 1. 0 x 4.6. .10.6
 B.Ba. (S.S.) .3.4 x 1.10 x 1.0. . 6.1

Weight complete 2850 lbs.

D.....	\$229.00
F.....	219.00
G.....	214.00
H.....	208.00
I.....	203.00
K.....	195.00
L.....	187.00

"M. M." finish

No. 7486

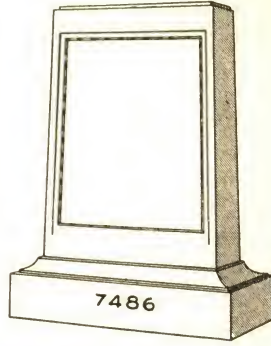

Die.....2.8 x 1. 0 x 3.8. .9.9
 B. Ba. (S.S.) .3.6 x 1.10 x 1.0. .6.5

Weight complete 2900 lbs.

D.....	\$235.00
F.....	225.00
G.....	220.00
H.....	215.00
I.....	210.00
K.....	203.00
L.....	196.00

"M. M." finish

No. 7485¹/₄

Die.....2.4 x 0.10 x 4.6. .8.9
 B. Ba. (S.S.) .3.4 x 1. 8 x 1.0. .5.7

Weight complete 2500 lbs.

D.....	\$204.00
F.....	196.00
G.....	191.00
H.....	187.00
I.....	183.00
K.....	176.00
L.....	169.00

"M. M." finish

No. 7486¹/₄

Die.....2.6 x 0.10 x 3. 4. .6.11
 B. Ba. (S.S.) .3.2 x 1. 6 x 0.10. .4. 0

Weight complete 1950 lbs.

D.....	\$187.00
F.....	181.00
G.....	177.00
H.....	174.00
I.....	170.00
K.....	165.00
L.....	160.00

"M. M." finish

No. 7485¹/₂

Die.....2.4 x 0.8 x 4.6. .7.0
 B. Ba. (S.S.) .3.4 x 1.4 x 1.0. .4.5

Weight complete 2000 lbs.

D.....	\$175.00
F.....	169.00
G.....	165.00
H.....	162.00
I.....	158.00
K.....	153.00
L.....	148.00

"M. M." finish

No. 7486¹/₂

Die.....2.6 x 0.8 x 3. 4. .5.7
 B. Ba. (S.S.) .3.2 x 1.4 x 0.10. .3.6

Weight complete 1600 lbs.

D.....	\$167.00
F.....	161.00
G.....	158.00
H.....	156.00
I.....	153.00
K.....	149.00
L.....	144.00

"M. M." finish

No. 7487

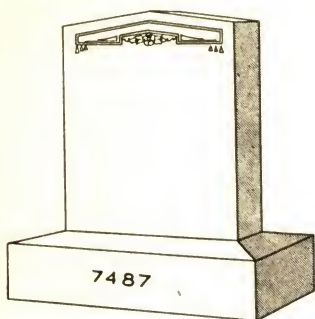

Die.....2.0 x 1.0 x 2.6 .5.0
 B. Ba. (S.S.)...2.8 x 1.6 x 1.0 .4.0
 Weight complete 1600 lbs.

D.....	\$93.50
F.....	88.50
G.....	86.00
H.....	83.50
I.....	81.00
K.....	77.50
L.....	73.50

"M. M." finish

No. 7487¹/₄

Die.....2.0 x 0.10 x 2.6 .4.2
 B. Ba. (S.S.)...2.8 x 1.4 x 1.0 .3.7
 Weight complete 1375 lbs.

D.....	\$81.00
F.....	77.00
G.....	75.00
H.....	73.00
I.....	70.50
K.....	67.50
L.....	64.50

"M. M." finish

No. 7487¹/₂

Die.....2.0 x 0.8 x 2.6 .3.4
 B. Ba. (S.S.)...2.8 x 1.2 x 1.0 .3.1
 Weight complete 1150 lbs.

D.....	\$67.50
F.....	64.50
G.....	62.50
H.....	61.00
I.....	59.50
K.....	57.00
L.....	54.50

"M. M." finish

No. 7487³/₄

Die.....1.8 x 0.6 x 2.4 .1.11
 B. Ba. (S.S.)...2.2 x 1.0 x 0.10 .1.10
 Weight complete 675 lbs.

D.....	\$43.00
F.....	41.00
G.....	40.00
H.....	39.00
I.....	38.25
K.....	36.75
L.....	35.25

"M. M." finish

No. 7488

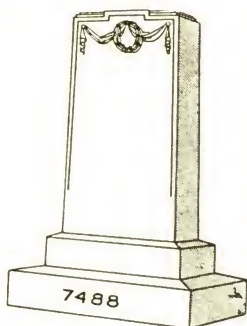

Die.....2.6 x 1.0 x 4.2 .10.5
 Base.....3.0 x 1.5 x 0.10 .3.7
 B. Ba. (S.S.)...4.0 x 2.2 x 0.8 .5.9
 Weight complete 3500 lbs.

D.....	\$287.00
F.....	273.00
G.....	266.00
H.....	259.00
I.....	252.00
K.....	242.00
L.....	231.00

"M. M." finish

No. 7488¹/₄

Die.....2.4 x 0.10 x 3.10 .7.5
 Base.....2.9 x 1.2 x 0.8 .2.2
 B. Ba. (S.S.)...3.8 x 1.10 x 0.6 .3.4
 Weight complete 2250 lbs.

D.....	\$217.00
F.....	207.00
G.....	202.00
H.....	198.00
I.....	193.00
K.....	186.00
L.....	178.00

"M. M." finish

No. 7488¹/₂

Die.....2.4 x 0.8 x 3.10 .6.0
 Base.....2.10 x 1.0 x 0.8 .1.11
 B. Ba. (S.S.)...3.8 x 1.8 x 0.6 .3.1
 Weight complete 1950 lbs.

D.....	\$194.00
F.....	186.00
G.....	182.00
H.....	178.00
I.....	174.00
K.....	168.00
L.....	162.00

"M. M." finish

No. 7489

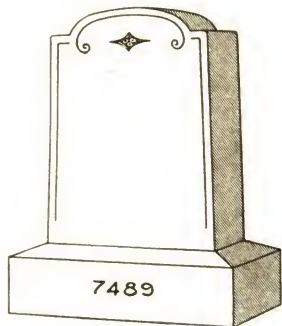

Die.....2.6 x 1. 0 x 3.6..8.9
 B. Ba. (S.S.) .3.6 x 1.10 x 1.0..5.4

Weight complete 2575 lbs.

D.....	\$170.00
F.....	161.00
G.....	157.00
H.....	153.00
I.....	149.00
K.....	142.00
L.....	135.00

"M. M." finish

No. 7490

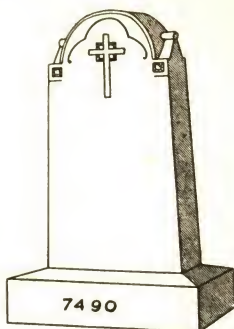

Die.....2.4 x 1. 0 x 4.4..10.1
 B. Ba. (S.S.) .3.4 x 1.10 x 1.0.. 6.1

Weight complete 3000 lbs.

D.....	\$194.00
F.....	184.00
G.....	179.00
H.....	174.00
I.....	169.00
K.....	161.00
L.....	154.00

"M. M." finish

No. 7489¹/₄

Die.....2.6 x 0.10 x 3. 6..7. 4
 B. Ba. (S.S.) .3.6 x 1. 8 x 0.10..4.10

Weight complete 2140 lbs.

D.....	\$152.00
F.....	144.00
G.....	140.00
H.....	136.00
I.....	132.00
K.....	126.00
L.....	120.00

"M. M." finish

No. 7490¹/₄

Die.....2. 0 x 0.10 x 3. 8..6.1
 B. Ba. (S.S.) .2.10 x 1. 6 x 0.10..3.7

Weight complete 1700 lbs.

D.....	131.00
F.....	125.00
G.....	122.00
H.....	119.00
I.....	116.00
K.....	111.00
L.....	107.00

"M. M." finish

No. 7489¹/₂

Die.....2.6 x 0.8 x 3. 6..5.10
 B. Ba. (S.S.) .3.6 x 1.4 x 0.10..3.11

Weight complete 1725 lbs.

D.....	\$125.00
F.....	119.00
G.....	116.00
H.....	113.00
I.....	110.00
K.....	106.00
L.....	102.00

"M. M." finish

No. 7490¹/₂

Die.....2. 0 x 0.8 x 3. 8..4.11
 B. Ba. (S.S.) .2.10 x 1.4 x 0.10..3. 2

Weight complete 1400 lbs.

D.....	\$113.00
F.....	109.00
G.....	106.00
H.....	104.00
I.....	101.00
K.....	97.50
L.....	94.00

"M. M." finish

No. 7491

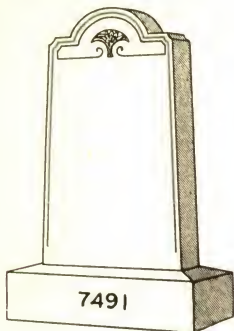

Die.....2.4 x 1.0 x 4.0..9.4
 B. Ba. (S.S.)...3.2 x 1.8 x 1.0..5.3

Weight complete 2600 lbs.

D.....	\$188.00
F.....	178.00
G.....	174.00
H.....	169.00
I.....	164.00
K.....	157.00
L.....	150.00

"M. M." finish

No. 7492

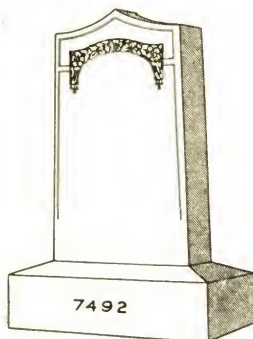

Die.....2.4 x 1.0 x 4.0..9.4
 B. Ba. (S.S.)...3.4 x 1.10 x 1.0..6.1

Weight complete 2600 lbs.

D.....	\$215.00
F.....	205.00
G.....	201.00
H.....	196.00
I.....	191.00
K.....	184.00
L.....	177.00

"M. M." finish

No. 7491¹/₄

Die.....2.0 x 0.10 x 3.4..5.7
 B. Ba. (S.S.)...2.8 x 1.4 x 0.10..3.0

Weight complete 1500 lbs.

D.....	\$127.00
F.....	121.00
G.....	118.00
H.....	116.00
I.....	113.00
K.....	109.00
L.....	104.00

"M. M." finish

No. 7492¹/₄

Die.....2.0 x 0.10 x 3.4..5.7
 B. Ba. (S.S.)...2.10 x 1.6 x 0.10..3.7

Weight complete 1525 lbs.

D.....	\$148.00
F.....	142.00
G.....	139.00
H.....	137.00
I.....	134.00
K.....	130.00
L.....	125.00

"M. M." finish

No. 7491¹/₂

Die.....2.0 x 0.8 x 3.4..4.5
 B. Ba. (S.S.)...2.8 x 1.2 x 0.10..2.7

Weight complete 1225 lbs.

D.....	\$109.00
F.....	105.00
G.....	103.00
H.....	100.00
I.....	98.00
K.....	95.00
L.....	91.50

"M. M." finish

No. 7492¹/₂

Die.....2.0 x 0.8 x 3.4..4.5
 B. Ba. (S.S.)...2.10 x 1.4 x 0.10..3.2

Weight complete 1275 lbs.

D.....	\$131.00
F.....	127.00
G.....	125.00
H.....	122.00
I.....	120.00
K.....	117.00
L.....	114.00

"M. M." finish

No. 7493

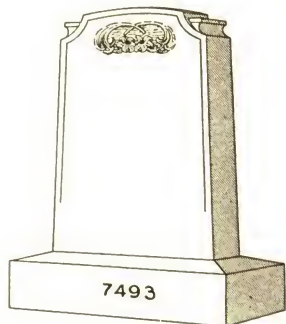

Die.....3.0 x 1. 0 x 4.2..12.6
 B.Ba. (S.S.) .4.0 x 1.10 x 1.0.. 7.4

Weight complete 3400 lbs.

D.....	\$230.00
F.....	218.00
G.....	212.00
H.....	205.00
I.....	199.00
K.....	190.00
L.....	180.00

"M. M." finish

No. 7494

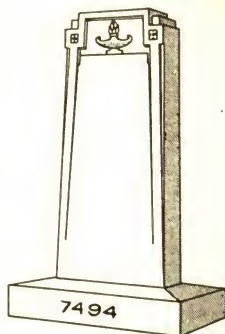

Die.....2.4 x 1.0 x 5. 6..12.10
 B.Ba. (S.S.) .3.8 x 2.4 x 0.10.. 7. 2

Weight complete 3500 lbs.

D.....	\$251.00
F.....	239.00
G.....	232.00
H.....	226.00
I.....	219.00
K.....	210.00
L.....	200.00

"M. M." finish

No. 7493¹/₄

Die.....2.6 x 0.10 x 3.6..7. 4
 B.Ba. (S.S.) .3.6 x 1. 8 x 1.0..5.10

Weight complete 2250 lbs.

D.....	\$164.00
F.....	156.00
G.....	153.00
H.....	149.00
I.....	145.00
K.....	140.00
L.....	134.00

"M. M." finish

No. 7494¹/₄

Die.....2.0 x 0.10 x 4.6..7.6
 B.Ba. (S.S.) .3.2 x 2. 0 x 0.8..4.3

Weight complete 2100 lbs.

D.....	\$170.00
F.....	162.00
G.....	158.00
H.....	155.00
I.....	151.00
K.....	145.00
L.....	140.00

"M. M." finish

No. 7493¹/₂

Die.....2.6 x 0.8 x 3.6..5.10
 B. Ba. (S.S.) .3.6 x 1.4 x 1.0..4. 8

Weight complete 1800 lbs.

D.....	\$138.00
F.....	132.00
G.....	129.00
H.....	126.00
I.....	123.00
K.....	119.00
L.....	115.00

"M. M." finish

No. 7494¹/₂

Die.....2.0 x 0. 8 x 4.6..6. 0
 B.Ba. (S.S.) .3.2 x 1.10 x 0.8..3.10

Weight complete 1700 lbs.

D.....	\$155.00
F.....	149.00
G.....	146.00
H.....	143.00
I.....	140.00
K.....	135.00
L.....	131.00

"M. M." finish

No. 7495

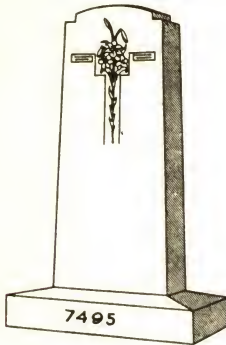

Die.....2.0 x 1.0 x 5. 2..10.4
 B.Ba. (S.S.) .3.6 x 2.2 x 0.10.. 6.4

Weight complete 3000 lbs.

D.....	\$249.00
F.....	239.00
G.....	234.00
H.....	229.00
I.....	223.00
K.....	216.00
L.....	208.00

Hone finish

No. 7496

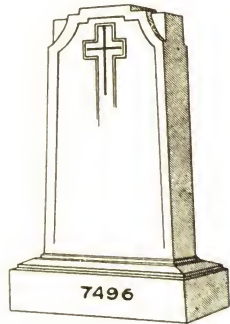

Die.....2.6 x 1. 0 x 4.8..11.8
 B.Ba. (S.S.) .3.6 x 1.10 x 1.0.. 6.5

Weight complete 3200 lbs.

D.....	\$220.00
F.....	208.00
G.....	202.00
H.....	197.00
I.....	191.00
K.....	182.00
L.....	173.00

"M. M." finish

No. 7495¹/₄

Die.....1.10 x 0.10 x 4.8..7. 2
 B.Ba. (S.S.) .3. 2 x 1.10 x 0.8..3.10

Weight complete 1900 lbs.

D.....	\$189.00
F.....	181.00
G.....	178.00
H.....	174.00
I.....	171.00
K.....	165.00
L.....	160.00

Hone finish

No. 7496¹/₄

Die.....2.4 x 0.10 x 4.4..8.5
 B. Ba. (S.S.) .3.2 x 1. 6 x 1.0..4.9

Weight complete 2300 lbs.

D.....	\$174.00
F.....	166.00
G.....	162.00
H.....	157.00
I.....	153.00
K.....	147.00
L.....	141.00

"M. M." finish

No. 7495¹/₂

Die.....1.10 x 0.8 x 4.8..5.8
 B. Ba. (S.S.) .3. 2 x 1.8 x 0.8..3.6

Weight complete 1600 lbs.

D.....	\$168.00
F.....	162.00
G.....	159.00
H.....	157.00
I.....	154.00
K.....	149.00
L.....	145.00

Hone finish

No. 7496¹/₂

Die.....2.4 x 0.8 x 4.4..6.9
 B. Ba. (S.S.) .3.2 x 1.4 x 1.0..4.3

Weight complete 1900 lbs.

D.....	\$150.00
F.....	144.00
G.....	140.00
H.....	137.00
I.....	134.00
K.....	128.00
L.....	123.00

"M. M." finish

No. 7497

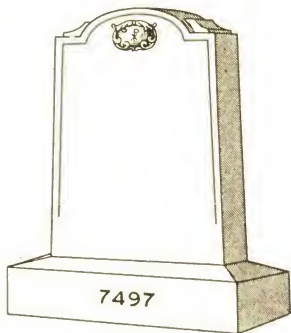

Die..... 3.0 x 1.2 x 4.2 .. 14.7
 B. Ba. (S.S.) . 4.0 x 2.0 x 1.0 .. 8.0

Weight complete 4000 lbs.

D.....	\$260.00
F.....	246.00
G.....	238.00
H.....	231.00
I.....	224.00
K.....	213.00
L.....	202.00

"M. M." finish

No. 7497¹/₄

Die..... 2.6 x 1. 0 x 3. 6 .. 8.9
 B. Ba. (S.S.) . 3.6 x 1. 10 x 0. 10 .. 5.4

Weight complete 2500 lbs.

D.....	\$178.00
F.....	170.00
G.....	165.00
H.....	161.00
I.....	157.00
K.....	150.00
L.....	143.00

"M. M." finish

No. 7497¹/₂

Die..... 2.6 x 0.10 x 3. 6 .. 7. 4
 B. Ba. (S.S.) . 3.6 x 1. 8 x 0.10 .. 4.10

Weight complete 2150 lbs.

D.....	\$153.00
F.....	145.00
G.....	142.00
H.....	138.00
I.....	134.00
K.....	129.00
L.....	123.00

"M. M." finish

No. 7498

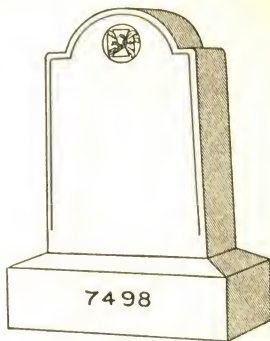

Die..... 3.0 x 1.0 x 4.10 .. 14.6
 B. Ba. (S.S.) . 4.2 x 2.0 x 1. 0 .. 8.4

Weight complete 4000 lbs.

D.....	\$258.00
F.....	244.00
G.....	237.00
H.....	230.00
I.....	223.00
K.....	212.00
L.....	201.00

"M. M." finish

No. 7498¹/₄

Die..... 2.6 x 0.10 x 4.0 .. 8. 4
 B. Ba. (S.S.) . 3. 6 x 1. 8 x 1.0 .. 5.10

Weight complete 2500 lbs.

D.....	\$175.00
F.....	167.00
G.....	163.00
H.....	159.00
I.....	155.00
K.....	149.00
L.....	143.00

"M. M." finish

No. 7498¹/₂

Die..... 2. 0 x 0.8 x 3. 2 .. 4.3
 B. Ba. (S.S.) . 2.10 x 1.4 x 0.10 .. 3.2

Weight complete 1300 lbs.

D.....	\$110.00
F.....	106.00
G.....	104.00
H.....	102.00
I.....	100.00
K.....	97.00
L.....	94.00

"M. M." finish

No. 7498³/₄

Die..... 1.6 x 0.6 x 2.6 .. 1.11
 B. Ba. (S.S.) . 2.2 x 1.0 x 0.8 .. 1. 5

Weight complete 600 lbs.

D.....	\$66.50
F.....	64.50
G.....	63.50
H.....	62.50
I.....	61.50
K.....	60.00
L.....	58.50

"M. M." finish

No. 7499

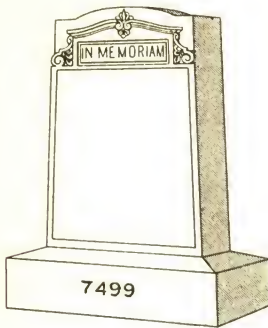

Die.....2.4 x 1.0 x 3.8..8.7
 B. Ba. (S.S.)...3.2 x 1.8 x 1.0..5.3
 Weight complete 2400 lbs.

D.....	\$192.00
F.....	180.00
G.....	175.00
H.....	171.00
I.....	167.00
K.....	160.00
L.....	154.00

"M. M." finish

No. 7499¹/₄

Die.....2.0 x 0.10 x 3. 2..5.3
 B. Ba. (S.S.)..2.8 x 1. 4 x 0.10..3.0
 Weight complete 1400 lbs.

D.....	\$139.00
F.....	133.00
G.....	131.00
H.....	128.00
I.....	126.00
K.....	122.00
L.....	118.00

"M. M." finish

No. 7499¹/₂

Die.....2.0 x 0.8 x 3. 2..4.3
 B. Ba. (S.S.)..2.8 x 1.2 x 0.10..2.7
 Weight complete 1200 lbs.

D.....	\$122.00
F.....	118.00
G.....	116.00
H.....	114.00
I.....	112.00
K.....	108.00
L.....	105.00

"M. M." finish

No. 7500

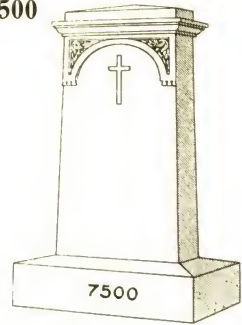

Cap.....2.11 x 1.5 x 0.9.. 3.1
 Die.....2. 8 x 1.2 x 4.2..13.0
 Base.....3. 8 x 2.0 x 1.0.. 7.4
 Weight complete 4150 lbs.

D.....	\$394.00
F.....	378.00
G.....	370.00
H.....	362.00
I.....	354.00
K.....	342.00
L.....	330.00

Hone finish
 No. 7500¹/₄

Cap.....2.9 x 1.2¹/₂ x 0.8.. 2.4
 Die.....2.6 x 1.0 x 4.0..10.0
 Base.....3.4 x 1.8 x 1.0.. 5.7
 Weight complete 3200 lbs.

D.....	\$324.00
F.....	312.00
G.....	306.00
H.....	300.00
I.....	293.00
K.....	284.00
L.....	275.00

Hone finish
 No. 7500¹/₂

Cap.....2.8 x 1. 1¹/₄ x 0. 7..1.10
 Die.....2.4 x 0.10 x 3. 8..7. 2
 Base.....3.2 x 1. 6 x 0.10..4. 0
 Weight complete 2300 lbs.

D.....	\$260.00
F.....	252.00
G.....	247.00
H.....	243.00
I.....	238.00
K.....	231.00
L.....	225.00

Hone finish
 No. 7500³/₄

Cap.....2.8 x 0.11¹/₄ x 0. 7..1.7
 Die.....2.4 x 0. 8 x 3. 8..5.8
 Base.....3.2 x 1. 4 x 0.10..3.6
 Weight complete 1900 lbs.

D.....	\$234.00
F.....	226.00
G.....	223.00
H.....	219.00
I.....	216.00
K.....	210.00
L.....	205.00

Hone finish

No. 7501



Die.....2.6 x 1. 0 x 3.6..8.9
 B. Ba. (S.S.) .3.6 x 1.10 x 1.0..6.5
 Weight complete 2700 lbs.

D.....	\$198.00
F.....	190.00
G.....	185.00
H.....	181.00
I.....	177.00
K.....	170.00
L.....	163.00

"M. M." finish

No. 7502

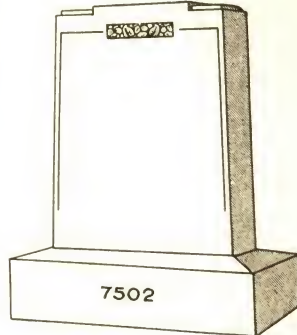

Die.....2.8 x 1. 0 x 3. 4..8.11
 B. Ba. (S.S.) .3.8 x 1.10 x 0.10..5. 7
 Weight complete 2550 lbs.

D.....	\$182.00
F.....	174.00
G.....	169.00
H.....	165.00
I.....	160.00
K.....	153.00
L.....	147.00

"M. M." finish

No. 7501¹/₄

Die.....2.4 x 0.10 x 3.2..6.2
 B. Ba. (S.S.) .3.4 x 1. 8 x 1.0..5.7
 Weight complete 2100 lbs.

D.....	\$160.00
F.....	154.00
G.....	151.00
H.....	148.00
I.....	145.00
K.....	140.00
L.....	135.00

"M. M." finish

No. 7502¹/₄

Die.....2.6 x 0.10 x 3. 0..6. 3
 B. Ba. (S.S.) .3.6 x 1. 8 x 0.10..4.10
 Weight complete 1950 lbs.

D.....	\$142.00
F.....	136.00
G.....	133.00
H.....	130.00
I.....	127.00
K.....	122.00
L.....	117.00

"M. M." finish

No. 7501¹/₂

Die.....2.4 x 0.8 x 3.2..4.11
 B. Ba. (S.S.) .3.4 x 1.4 x 1.0..4. 5
 Weight complete 1600 lbs.

D.....	\$137.00
F.....	133.00
G.....	130.00
H.....	128.00
I.....	125.00
K.....	121.00
L.....	118.00

"M. M." finish

No. 7502¹/₂

Die.....2.6 x 0.8 x 3. 0..5.0
 B. Ba. (S.S.) .3.6 x 1.6 x 0.10..4.5
 Weight complete 1650 lbs.

D.....	\$123.00
F.....	119.00
G.....	116.00
H.....	114.00
I.....	111.00
K.....	107.00
L.....	104.00

"M. M." finish

No. 7503

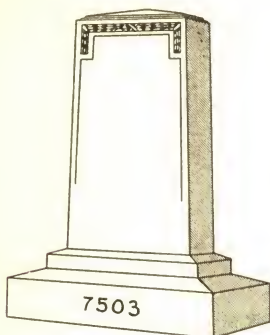

Die.....2. 8 x 1.2 x 5.0..15.7
 B.Ba. (S.S.) .3.10 x 2.4 x 1.0..10.5
 Weight complete 4600 lbs.

D.....	\$373.00
F.....	357.00
G.....	349.00
H.....	342.00
I.....	334.00
K.....	322.00
L.....	310.00

"M. M." finish

No. 7504

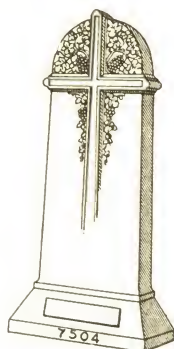

Die.....2.6 x 1. 2 x 5.6..16. 1
 Base.....3.2 x 1.10 x 1.0.. 5.10
 Weight complete 2900 lbs.

D.....	\$437.00
F.....	\$415.00
G.....	404.00
H.....	393.00
I.....	382.00
K.....	366.00
L.....	349.00

"M. M." finish

No. 7503¹/₄

Die.....2.4 x 1.0 x 4. 0..9.4
 B. Ba. (S.S.) .3.4 x 2.0 x 0.10..5.7
 Weight complete 2600 lbs.

D.....	\$251.00
F.....	240.00
G.....	237.00
H.....	232.00
I.....	227.00
K.....	220.00
L.....	213.00

"M. M." finish

No. 7504¹/₄

Die.....2.6 x 1.0 x 5.6..13.9
 Base.....3.2 x 1.8 x 1.0.. 5.3
 Weight complete 2300 lbs.

D.....	\$399.00
F.....	381.00
G.....	371.00
H.....	362.00
I.....	352.00
K.....	338.00
L.....	324.00

"M. M." finish

No. 7503¹/₂

Die.....2.4 x 0.10 x 4. 0..7.9
 B.Ba. (S.S.) .3.4 x 1.10 x 0.10..5.1
 Weight complete 2200 lbs.

D.....	\$224.00
F.....	216.00
G.....	212.00
H.....	208.00
I.....	205.00
K.....	199.00
L.....	193.00

"M. M." finish

No. 7504¹/₂

Die.....2.6 x 0.10 x 5.6..11.6
 Base.....3.2 x 1. 6 x 1.0.. 4.9
 Weight complete 2000 lbs.

D.....	\$365.00
F.....	349.00
G.....	341.00
H.....	333.00
I.....	325.00
K.....	312.00
L.....	300.00

"M. M." finish

No. 7505



Die.....2.6 x 0.10 x 6.8..13.11
Weight complete 2200 lbs.

D.....	\$357.00
F.....	343.00
G.....	336.00
H.....	329.00
I.....	322.00
K.....	312.00
L.....	301.00

"M. M." finish

No. 7505¹/₄

Die.....2.6 x 0.8 x 6.8..11.1
Weight complete 1750 lbs.

D.....	\$315.00
F.....	303.00
G.....	298.00
H.....	292.00
I.....	287.00
K.....	279.00
L.....	270.00

"M. M." finish

No. 7505¹/₂

Die.....2.2 x 0.6 x 5.4..5.9
Weight complete 900 lbs.

D.....	\$233.00
F.....	227.00
G.....	224.00
H.....	221.00
I.....	219.00
K.....	214.00
L.....	210.00

"M. M." finish

No. 7506



Die.....2.8 x 0.10 x 4.8..10.4
Base.....3.4 x 1.6 x 1.0..5.0

Weight complete 2650 lbs.

D.....	\$293.00
F.....	277.00
G.....	270.00
H.....	262.00
I.....	254.00
K.....	243.00
L.....	231.00

"M. M." finish

No. 7506¹/₄

Die.....2.2 x 0.8 x 3.8..5.4
Base.....2.8 x 1.2 x 0.10..2.7

Weight complete 1350 lbs.

D.....	\$204.00
F.....	196.00
G.....	192.00
H.....	188.00
I.....	184.00
K.....	178.00
L.....	172.00

"M. M." finish

No. 7506¹/₂

Die.....1.8 x 0.6 x 2.10..2.4
Base.....2.2 x 1.0 x 0.8..1.5

Weight complete 625 lbs.

D.....	\$133.00
F.....	129.00
G.....	127.00
H.....	125.00
I.....	124.00
K.....	121.00
L.....	118.00

"M. M." finish

No. 7507

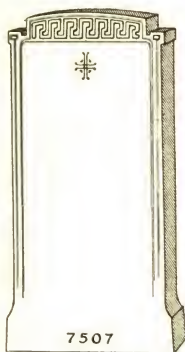

Die.....2.6 x 1.0 x 5.2..12.11
 Weight complete 2300 lbs.

D.....	\$206.00
F.....	194.00
G.....	187.00
H.....	181.00
I.....	174.00
K.....	164.00
L.....	155.00

"M. M." finish
 Four-inch rough butt included in above sizes

No. 7507¹/₄

Die.....2.6 x 0.10 x 5.2..10.9
 Weight complete 1850 lbs.

D.....	\$180.00
F.....	170.00
G.....	164.00
H.....	159.00
I.....	154.00
K.....	145.00
L.....	137.00

"M. M." finish
 Four-inch rough butt included in above sizes

No. 7507¹/₂

Die.....2.6 x 0.8 x 5.2..8.7
 Weight complete 1475 lbs.

D.....	\$154.00
F.....	146.00
G.....	141.00
H.....	137.00
I.....	133.00
K.....	126.00
L.....	120.00

"M. M." finish
 Four-inch rough butt included in above sizes

No. 7508

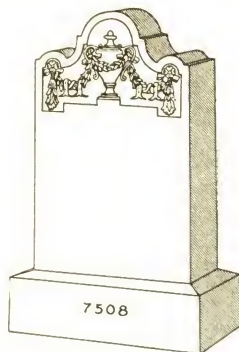

Die.....2.10 x 1.0 x 4.8..13.3
 B.Ba. (S.S.) .3.10 x 1.10 x 1.0.. 7.0
 Weight complete 3500 lbs.

D.....	\$317.00
F.....	303.00
G.....	297.00
H.....	290.00
I.....	284.00
K.....	274.00
L.....	264.00

"M. M." finish

No. 7508¹/₄

Die.....2.10 x 0.10 x 4.8..11.0
 B.Ba. (S.S.) .3.10 x 1.8 x 1.0.. 6.5
 Weight complete 3000 lbs.

D.....	\$287.00
F.....	277.00
G.....	271.00
H.....	266.00
I.....	260.00
K.....	252.00
L.....	244.00

"M. M." finish

No. 7508¹/₂

Die.....2.10 x 0.8 x 4.8..8.10
 B.Ba. (S.S.) .3.10 x 1.6 x 1.0..5.9
 Weight complete 2550 lbs.

D.....	\$258.00
F.....	250.00
G.....	245.00
H.....	241.00
I.....	236.00
K.....	230.00
L.....	223.00

"M. M." finish

No. 7509

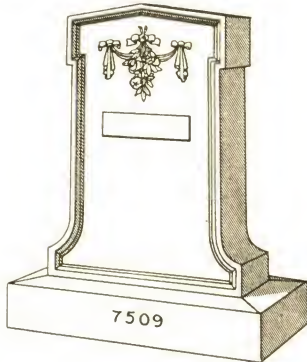

Die..... 3.4 x 0.10 x 5.0 .. 13.11
 B.Ba. (S.S.) .4.4 x 1. 8 x 1.0 .. 7. 3

Weight complete 3400 lbs.

- D.....\$344.00
- F..... 330.00
- G..... 323.00
- H..... 316.00
- I..... 309.00
- K..... 299.00
- L..... 288.00

"M. M." finish

No. 7509¹/₄

Die..... 3.4 x 0.8 x 5.0 .. 11.1
 B. Ba. (S.S.) .4.4 x 1.6 x 1.0 .. 6.6

Weight complete 2750 lbs.

- D.....\$305.00
- F..... 293.00
- G..... 288.00
- H..... 282.00
- I..... 277.00
- K..... 269.00
- L..... 260.00

"M. M." finish

No. 7509¹/₂

Die..... 2.6 x 0.6 x 3. 8 .. 4.7
 B. Ba. (S.S.) .3.4 x 1.2 x 0.10 .. 3.3

Weight complete 1250 lbs.

- D.....\$197.00
- F..... 193.00
- G..... 190.00
- H..... 188.00
- I..... 186.00
- K..... 182.00
- L..... 179.00

"M. M." finish

No. 7510

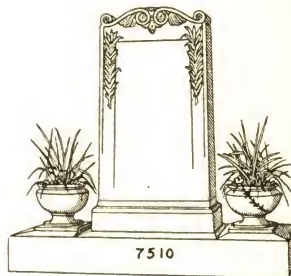

Die..... 3. 6 x 1. 0 x 6.2 .. 21.7
 Base..... 4. 0 x 1. 6 x 1.0 .. 6.0
 2 Vases..... 1.10 x 1.10 x 1.6 .. 10.2
 B.Ba. (S.S.) .9. 0 x 2. 8 x 1.2 .. 28.0

Weight complete 11000 lbs.

- D.....\$784.00
- F..... 746.00
- G..... 727.00
- H..... 708.00
- I..... 690.00
- K..... 661.00
- L..... 633.00

"M. M." finish

No. 7510¹/₄

Die..... 2.10 x 0.10 x 5. 0 .. 11.10
 Base..... 3. 3 x 1. 3 x 0.10 .. 3. 5
 2 Vases..... 1. 6 x 1. 6 x 1. 2 .. 5. 4
 B.Ba. (S.S.) .7. 6 x 2. 2 x 1. 0 .. 16. 4

Weight complete 6000 lbs.

- D.....\$467.00
- F..... 447.00
- G..... 436.00
- H..... 426.00
- I..... 416.00
- K..... 400.00
- L..... 385.00

"M. M." finish

No. 7510¹/₂

Die..... 2.4 x 0. 8 x 4. 2 .. 6.6
 Base..... 2.8 x 1. 0 x 0. 8 .. 1.9
 2 Vases..... 1.2 x 1. 2 x 1. 0 .. 2.8
 B.Ba. (S.S.) .6.0 x 1.10 x 0.10 .. 9.2

Weight complete 3300 lbs.

- D.....\$330.00
- F..... 320.00
- G..... 315.00
- H..... 311.00
- I..... 306.00
- K..... 299.00
- L..... 291.00

"M. M." finish

No. 7511

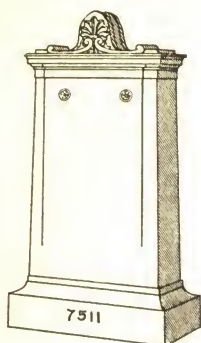

Cap.....2.9 x 1.5 x 1. 2. 4. 7
 Die.....2.4 x 1.0 x 3.10 . 8.11
 Base.....3.0 x 1.8 x 1. 0. 5. 0

Weight complete 2700 lbs.

D.....\$419.00
 F.....401.00
 G.....392.00
 H.....382.00
 I.....373.00
 K.....359.00
 L.....345.00

"M. M." finish

No. 7511¹/₄

Cap.....2.4 x 1. 3 x 1.1. 3. 2
 Die.....2.0 x 0.10 x 3.6. 5.10
 Base.....2.8 x 1. 6 x 1.0. 4. 0

Weight complete 1950 lbs.

D.....\$348.00
 F.....336.00
 G.....329.00
 H.....323.00
 I.....316.00
 K.....306.00
 L.....297.00

"M. M." finish

No. 7511¹/₂

Cap.....2.4 x 1.1 x 1.1. 2.9
 Die.....2.0 x 0.8 x 3.6. 4.8
 Base.....2.8 x 1.4 x 1.0. 3.7

Weight complete 1650 lbs.

D.....\$319.00
 F.....309.00
 G.....303.00
 H.....298.00
 I.....292.00
 K.....284.00
 L.....276.00

"M. M." finish

No. 7512

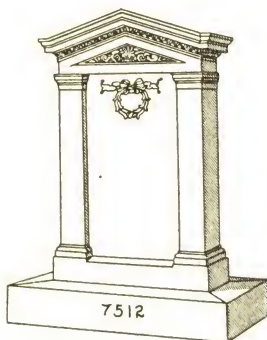

Cap.....4. 4 x 1.5¹/₂ x 1.8. 10.10
 Die.....3.10 x 1.0 x 4.8. 17.11
 Base.....3.11 x 1.1 x 0.8. 2.10
 B.Ba. (S.S.) 5. 4 x 2.4 x 1.0. 12. 5

Weight complete 6500 lbs.

D.....\$836.00
 F.....804.00
 G.....788.00
 H.....773.00
 I.....757.00
 K.....733.00
 L.....709.00

"M. M." finish

No. 7512¹/₄

Cap.....3.8 x 1. 3 x 1. 4. 6.1
 Die.....3.2 x 0.10 x 3.10. 10.1
 Base.....3.3 x 0.11 x 0. 6. 1.6
 B.Ba. (S.S.) 4.6 x 2. 0 x 0.10. 7.6

Weight complete 3100 lbs.

D.....\$634.00
 F.....616.00
 G.....607.00
 H.....599.00
 I.....590.00
 K.....576.00
 L.....563.00

"M. M." finish

No. 7513

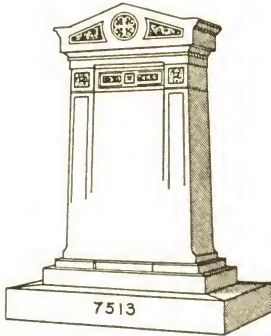

Cap.....	4. 0 x 1. 3 x 1. 8..	8.4
Die.....	3. 6 x 1. 0 x 5. 0..	17.6
Base.....	4. 6 x 1. 8 x 0. 8..	5.0
B.Ba. (S.S.)	5.10 x 2. 6 x 0. 10..	12.2

Weight complete 6700 lbs.

D.....	\$672.00
F.....	642.00
G.....	626.00
H.....	611.00
I.....	595.00
K.....	572.00
L.....	549.00

"M. M." finish

No. 7514

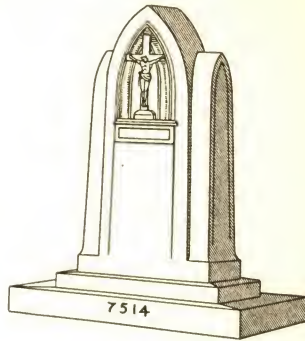

Die.....	3. 0 x 1. 2 x 5. 0..	17. 6
Base.....	3. 8 x 1. 7 x 0. 4..	1. 11
B.Ba. (S.S.)	5. 2 x 2. 6 x 0. 6..	6. 6

Weight complete 4100 lbs.

D.....	\$415.00
F.....	395.00
G.....	386.00
H.....	376.00
I.....	366.00
K.....	352.00
L.....	337.00

"M. M." finish

No. 7514¹/₄

Die.....	2.10 x 1. 0 x 4. 10..	13.8
Base.....	3. 4 x 1. 5 x 0. 4..	1. 7
B.Ba. (S.S.)	4. 8 x 2. 4 x 0. 6..	5. 5

Weight complete 3300 lbs.

D.....	\$354.00
F.....	338.00
G.....	331.00
H.....	323.00
I.....	316.00
K.....	304.00
L.....	293.00

"M. M." finish

No. 7513¹/₄

Cap.....	4. 0 x 1. 1 x 1. 8..	7.3
Die.....	3. 6 x 0. 10 x 5. 0..	14.7
Base.....	4. 6 x 1. 6 x 0. 8..	4.6
B.Ba. (S.S.)	5.10 x 2. 4 x 0. 10..	11.4

Weight complete 5000 lbs.

D.....	\$606.00
F.....	586.00
G.....	573.00
H.....	560.00
I.....	546.00
K.....	527.00
L.....	507.00

"M. M." finish

No. 7514¹/₂

Die.....	2.8 x 0. 10 x 4. 8..	10. 4
Base.....	3. 2 x 1. 3 x 0. 4..	1. 4
B.Ba. (S.S.)	4. 6 x 2. 2 x 0. 6..	4. 11

Weight complete 2600 lbs.

D.....	\$262.00
F.....	250.00
G.....	244.00
H.....	239.00
I.....	233.00
K.....	224.00
L.....	215.00

"M. M." finish

No. 7515



Cap. 4.6 x 1.4 x 1. 8. .10.0
 Die. 4.0 x 1.2 x 6. 6. .30.4
 Base. 4.6 x 1.5 x 1. 6. . 9.7
 B.Ba. (S.S.) .6.4 x 3.2 x 0.10. .16.9

Weight complete 9900 lbs.

D. \$1322.00
 F. 1278.00
 G. 1256.00
 H. 1234.00
 I. 1212.00
 K. 1179.00
 L. 1146.00

"M. M." finish

No. 7516

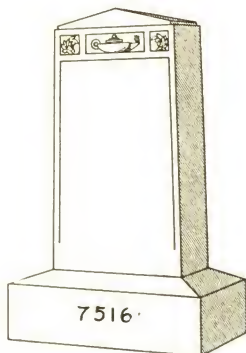

Die. 2.0 x 1. 0 x 4. 6. .9.0
 B.Ba. (S.S.) .3.0 x 1.10 x 0.10. .4.7

Weight complete 2400 lbs.

D. \$210.00
 F. 200.00
 G. 195.00
 H. 190.00
 I. 185.00
 K. 178.00
 L. 171.00

"M. M." finish

No. 7516¹/₄

Die. 2.0 x 0.10 x 4. 6. .7.6
 B.Ba. (S.S.) .3.0 x 1. 8 x 0.10. .4.2

Weight complete 2025 lbs.

D. \$189.00
 F. 181.00
 G. 177.00
 H. 173.00
 I. 169.00
 K. 163.00
 L. 157.00

"M. M." finish

No. 7515¹/₄

Cap. 4.0 x 1.2 x 1. 6. . 7.0
 Die. 3.8 x 1.0 x 5.10. .21.5
 Base. 4.0 x 1.3 x 1. 4. . 6.8
 B.Ba. (S.S.) .5.8 x 2.8 x 0. 8. .10.1

Weight complete 7425 lbs.

D. \$1143.00
 F. 1107.00
 G. 1090.00
 H. 1072.00
 I. 1055.00
 K. 1029.00
 L. 1002.00

"M. M." finish

No. 7516¹/₂

Die. 2.0 x 0.8 x 4. 6. .6.0
 B. Ba. (S.S.) .3.0 x 1.6 x 0.10. .3.9

Weight complete 1750 lbs.

D. \$168.00
 F. 162.00
 G. 159.00
 H. 156.00
 I. 153.00
 K. 148.00
 L. 143.00

"M. M." finish

No. 7517

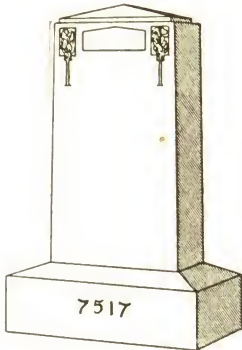

Die.....2.0 x 1. 0 x 4. 6..9.0
 B.Ba. (S.S.) .3.0 x 1.10 x 0.10..4.7
 Weight complete 2400 lbs.

- D.....\$192.00
- F.....182.00
- G.....177.00
- H.....172.00
- I.....167.00
- K.....160.00
- L.....153.00

"M. M." finish

No. 7518

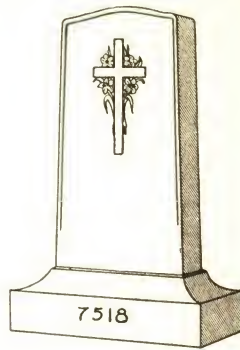

Die.....2.4 x 1. 0 x 5.0..11.8
 B.Ba. (S.S.) .3.4 x 1.10 x 1.2.. 7.2
 Weight complete 3300 lbs.

- D.....\$281.00
- F.....269.00
- G.....263.00
- H.....257.00
- I.....251.00
- K.....242.00
- L.....233.00

"M. M." finish

No. 7517¹/₄

Die.....2.0 x 0.10 x 4. 6..7.6
 B.Ba. (S.S.) .3.0 x 1. 8 x 0.10..4.2
 Weight complete 2025 lbs.

- D.....\$170.00
- F.....162.00
- G.....158.00
- H.....154.00
- I.....150.00
- K.....144.00
- L.....138.00

"M. M." finish

No. 7518¹/₄

Die.....2.4 x 0.10 x 5.0..9.9
 B. Ba. (S.S.) .3.4 x 1. 8 x 1.2..6.6
 Weight complete 2875 lbs.

- D.....\$269.00
- F.....259.00
- G.....254.00
- H.....249.00
- I.....244.00
- K.....237.00
- L.....230.00

"M. M." finish

No. 7517¹/₂

Die.....2.0 x 0.8 x 4. 6..6.0
 B. Ba. (S.S.) .3.0 x 1.6 x 0.10..3.9
 Weight complete 1750 lbs.

- D.....\$148.00
- F.....142.00
- G.....139.00
- H.....136.00
- I.....133.00
- K.....128.00
- L.....123.00

"M. M." finish

No. 7518¹/₂

Die.....2.4 x 0.8 x 5.0..7. 9
 B. Ba. (S.S.) .3.4 x 1.6 x 1.2..5.10
 Weight complete 2400 lbs.

- D.....\$235.00
- F.....227.00
- G.....223.00
- H.....219.00
- I.....215.00
- K.....209.00
- L.....203.00

"M. M." finish

No. 7519

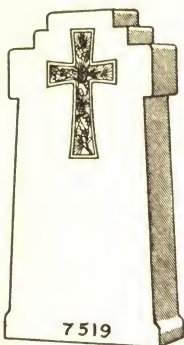

Die.....3.0 x 1.0 x 5.4..16.0
Weight complete 2700 lbs.

D.....	\$337.00
F.....	321.00
G.....	313.00
H.....	305.00
I.....	297.00
K.....	285.00
L.....	273.00

"M. M." finish

No. 7519¹/₄

Die.....2.6 x 0.10 x 4.6..9.5
Weight complete 1575 lbs.

D.....	\$234.00
F.....	224.00
G.....	219.00
H.....	214.00
I.....	209.00
K.....	202.00
L.....	195.00

"M. M." finish

No. 7519¹/₂

Die.....2.6 x 0.8 x 4.6..7.6
Weight complete 1300 lbs.

D.....	\$211.00
F.....	203.00
G.....	199.00
H.....	195.00
I.....	191.00
K.....	185.00
L.....	179.00

"M. M." finish

No. 7520

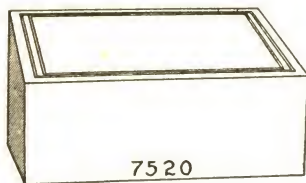

Die.....2.0 x 1.2 x 1.0..2.4
Weight complete 400 lbs.

C.....	\$41.50
D.....	36.25
F.....	34.00
G.....	32.75
H.....	31.50
I.....	30.25
K.....	28.50
L.....	26.75

"M. M." finish

No. 7520¹/₄

Die.....1.10 x 1.2 x 0.10..1.9
Weight complete 300 lbs.

C.....	\$32.25
D.....	28.25
F.....	26.50
G.....	25.50
H.....	24.50
I.....	23.50
K.....	22.25
L.....	21.00

"M. M." finish

No. 7520¹/₂

Die.....1.8 x 1.2 x 0.10..1.7
Weight complete 275 lbs.

C.....	\$28.25
D.....	24.75
F.....	23.25
G.....	22.50
H.....	21.75
I.....	21.00
K.....	19.75
L.....	18.50

"M. M." finish

No. 7521

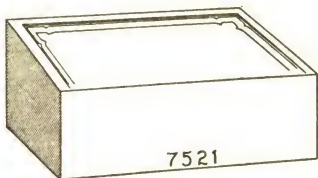

Die.....2.2 x 1.2 x 1.0...2.6
Weight complete 400 lbs.

C.....	\$53.00
D.....	47.25
F.....	44.75
G.....	43.50
H.....	42.25
I.....	41.00
K.....	39.00
L.....	37.00

"M. M." finish

No. 7522

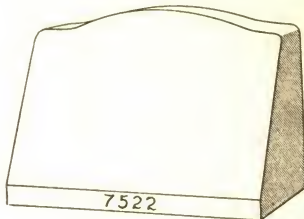

Die.....2.0 x 1.0 x 1.4...2.8
Weight complete 440 lbs.

C.....	\$47.00
D.....	41.00
F.....	38.25
G.....	37.00
H.....	35.75
I.....	34.50
K.....	32.50
L.....	30.50

"M. M." finish

No. 7521¹/₄

Die.....2.0 x 1.2 x 0.10...1.11
Weight complete 325 lbs.

C.....	\$43.75
D.....	39.50
F.....	37.50
G.....	36.50
H.....	35.50
I.....	34.50
K.....	33.00
L.....	31.50

"M. M." finish

No. 7522¹/₄

Die.....1.10 x 0.10 x 1.2...1.9
Weight complete 300 lbs.

C.....	\$33.00
D.....	29.00
F.....	27.25
G.....	26.25
H.....	25.25
I.....	24.25
K.....	23.00
L.....	21.75

"M. M." finish

No. 7521¹/₂

Die.....1.10 x 1.0 x 0.10...1.6
Weight complete 260 lbs.

C.....	\$36.50
D.....	33.00
F.....	31.50
G.....	30.75
H.....	30.00
I.....	29.25
K.....	28.00
L.....	26.75

"M. M." finish

No. 7522¹/₂

Die.....1.10 x 0.8 x 1.2...1.5
Weight complete 235 lbs.

C.....	\$27.00
D.....	23.75
F.....	22.25
G.....	21.50
H.....	20.75
I.....	20.00
K.....	19.00
L.....	18.00

"M. M." finish

No. 7523

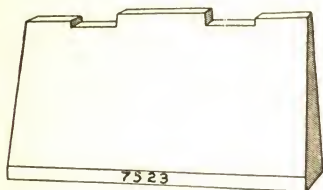

Die.....2.2 x 1.0 x 1.2..2.6

Weight complete 400 lbs.

C.....	\$44.00
D.....	38.25
F.....	35.75
G.....	34.50
H.....	33.25
I.....	32.00
K.....	30.00
L.....	28.00

"M. M." finish

No. 7524

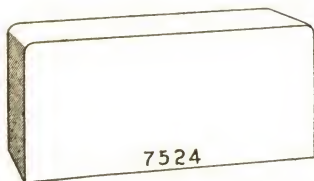

Die.....2.0 x 1.0 x 1.0..2.0

Weight complete 360 lbs.

C.....	\$31.50
D.....	27.00
F.....	25.00
G.....	24.00
H.....	23.00
I.....	22.00
K.....	20.50
L.....	19.00

"M. M." finish

No. 7523¹/₄

Die.....2.0 x 0.10 x 1.0..1.8

Weight complete 275 lbs.

C.....	\$31.75
D.....	28.00
F.....	26.25
G.....	25.25
H.....	24.25
I.....	23.25
K.....	22.00
L.....	20.75

"M. M." finish

No. 7524¹/₄

Die.....1.10 x 0.10 x 0.10..1.3

Weight complete 225 lbs.

C.....	\$21.25
D.....	18.50
F.....	17.25
G.....	16.50
H.....	15.75
I.....	15.00
K.....	14.00
L.....	13.00

"M. M." finish

No. 7523¹/₂

Die.....2.0 x 0.8 x 1.0..1.4

Weight complete 220 lbs.

C.....	\$25.50
D.....	22.50
F.....	21.25
G.....	20.50
H.....	19.75
I.....	19.00
K.....	18.00
L.....	17.00

"M. M." finish

No. 7524¹/₂

Die.....1.8 x 0.8 x 0.8..0.9

Weight complete 135 lbs.

C.....	\$14.50
D.....	12.75
F.....	12.00
G.....	11.50
H.....	11.00
I.....	10.50
K.....	10.00
L.....	9.50

"M. M." finish

No. 7525

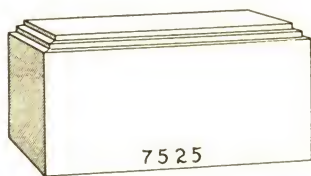

Die.....2.0 x 1.0 x 1.0..2.0

Weight complete 360 lbs.

C.....	\$39.00
D.....	34.50
F.....	32.50
G.....	31.50
H.....	30.50
I.....	29.50
K.....	28.00
L.....	26.50

"M. M." finish

No. 7525¹/₄

Die.....1.10 x 0.10 x 0.10..1.3

Weight complete 220 lbs.

C.....	\$27.25
D.....	24.50
F.....	23.25
G.....	22.50
H.....	21.75
I.....	21.00
K.....	20.00
L.....	19.00

"M. M." finish

No. 7525¹/₂

Die.....1.8 x 0.8 x 0.8..0.9

Weight complete 130 lbs.

C.....	\$19.00
D.....	17.25
F.....	16.50
G.....	16.00
H.....	15.50
I.....	15.00
K.....	14.50
L.....	14.00

"M. M." finish

No. 7526

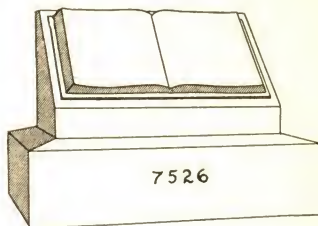

Die.....2.2 x 1.2 x 1.2..2.11

B. Base.....2.8 x 1.8 x 0.8..3.0

Weight complete 975 lbs.; no B. B. 540 lbs.

C.....	\$68.00
D.....	61.50
F.....	58.50
G.....	57.00
H.....	55.50
I.....	54.00
K.....	52.00
L.....	50.00

If B. B. is omitted deduct \$10.80
Top of book gl.; balance sand finished

No. 7526¹/₄

Die.....2.0 x 1.0 x 1.1..2.2

B. Base.....2.6 x 1.6 x 0.8..2.6

Weight complete 770 lbs.; no B. B. 450 lbs.

C.....	\$54.50
D.....	49.50
F.....	47.25
G.....	46.25
H.....	45.25
I.....	44.25
K.....	42.50
L.....	40.75

If B. B. is omitted deduct \$9.00
Top of book gl.; balance sand finished

No. 7526¹/₂

Die.....1.10 x 0.10 x 1.0..1.6

B. Base.....2.4 x 1.4 x 0.8..2.1

Weight complete 600 lbs.; no B. B. 375 lbs.

C.....	\$42.50
D.....	39.00
F.....	37.50
G.....	36.75
H.....	36.00
I.....	35.25
K.....	34.00
L.....	32.75

If B. B. is omitted deduct \$7.50
Top of book gl.; balance sand finished

No. 7527

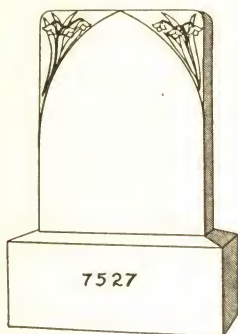

Die.....1.2 x 0. 6 x 1.6..0.11
 B. Base....1.6 x 0.10 x 0.8..0.10
 Weight complete 315 lbs.; no B. B. 150 lbs.

C.....	\$32.25
D.....	30.25
F.....	29.25
G.....	28.75
H.....	28.25
I.....	27.75
K.....	27.00
L.....	26.25

If B. B. is omitted deduct \$3.15

No. 7528

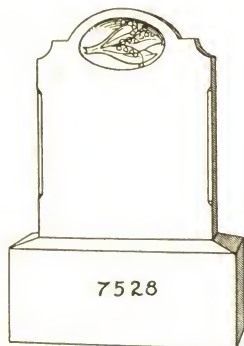

Die.....1.2 x 0. 6 x 1.6..0.11
 B. Base....1.6 x 0.10 x 0.8..0.10
 Weight complete 300 lbs.; no B. B. 150 lbs.

C.....	\$36.25
D.....	34.25
F.....	33.25
G.....	32.75
H.....	32.25
I.....	31.75
K.....	31.00
L.....	30.25

If B. B. is omitted deduct \$3.15

No. 7527¹/₄

Die.....1.2 x 0.4 x 1.6..0.7
 B. Base....1.6 x 0.8 x 0.8..0.8
 Weight complete 225 lbs.; no B. B. 105 lbs.

C.....	\$26.50
D.....	25.25
F.....	24.75
G.....	24.50
H.....	24.25
I.....	24.00
K.....	23.50
L.....	23.00

If B. B. is omitted deduct \$2.50

No. 7528¹/₄

Die.....1.2 x 0.4 x 1.6..0.7
 B. Base....1.6 x 0.8 x 0.8..0.8
 Weight complete 215 lbs.; no B. B. 120 lbs.

C.....	\$30.50
D.....	29.25
F.....	28.75
G.....	28.50
H.....	28.25
I.....	28.00
K.....	27.50
L.....	27.00

If B. B. is omitted deduct \$2.50

No. 7529

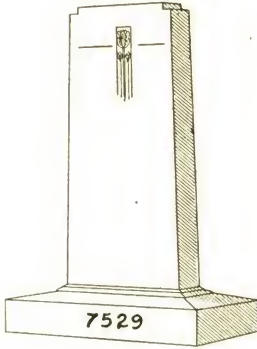

Die.....	2.0 x 1.0 x 4.8..	.9. 4
B. Ba. (S.S.)..	3.4 x 2.2 x 0.8..	.4. 10
Weight complete 2400 lbs.		
C.....	\$236.00	
D.....	215.00	
F.....	206.00	
G.....	201.00	
H.....	196.00	
I.....	191.00	
K.....	184.00	
L.....	177.00	
"M. M." finish		

No. 7529¹/₄

Die.....	2.0 x 0.10 x 4.8..	.7. 9
B. Ba. (S.S.)..	3.4 x 2.0 x 0.8..	.4. 5
Weight complete 2100 lbs.		
C.....	\$208.00	
D.....	191.00	
F.....	183.00	
G.....	179.00	
H.....	175.00	
I.....	171.00	
K.....	165.00	
L.....	159.00	
"M. M." finish		

No. 7529¹/₂

Die.....	2.0 x 0.8 x 4.8..	.6. 3
B. Ba. (S.S.)..	3.4 x 1.10 x 0.8..	.4. 1
Weight complete 1775 lbs.		
C.....	\$180.00	
D.....	166.00	
F.....	160.00	
G.....	157.00	
H.....	154.00	
I.....	151.00	
K.....	146.00	
L.....	141.00	
"M. M." finish		

No. 9000

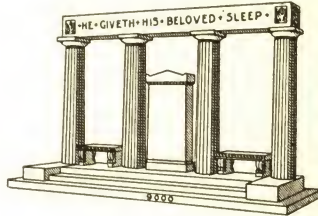

Total height.....	12.0
Height of columns....	9.2 ¹ / ₂
Diameter of columns...	1.6
Height of inscription tablet.....	6.6
Base.....	21.6 x 6.8
D.....	\$4472.00
F.....	4228.00
G.....	4107.00
H.....	3985.00
I.....	3864.00
K.....	3682.00
L.....	3500.00

No. 9000¹/₄

Total height.....	10.2 ¹ / ₂
Height of columns....	7.9 ¹ / ₂
Diameter of columns..	1.3
Height of inscription tablet.....	5.6 ¹ / ₂
Base.....	17.11 x 5.8
D.....	\$2998.00
F.....	2852.00
G.....	2779.00
H.....	2706.00
I.....	2633.00
K.....	2524.00
L.....	2414.00

No. 9001

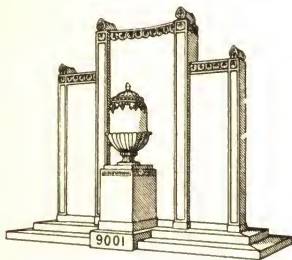

Total height of center die to top of finial.....	15.9
Total height of wings to top of finial.....	12.7
Height of urn alone.....	5.6
Thickness of main die at pilasters.....	1.9
Thickness of wings at pilasters.....	1.1
Lower base.....	20.0 x 6.0
D.....	\$3872.00
F.....	3678.00
G.....	3581.00
H.....	3484.00
I.....	3387.00
K.....	3242.00
L.....	3096.00

No. 9001 1/4

Total height of center die to top of finial....	9.9
Total height of wings to top of finial.....	7.10 1/2
Height of urn alone.....	3.6
Thickness of main die at pilasters.....	1.0
Thickness of wings at pilasters.....	0.8
Lower base.....	12.7 x 3.6
D.....	\$2226.00
F.....	2124.00
G.....	2073.00
H.....	2022.00
I.....	1971.00
K.....	1895.00
L.....	1818.00

No. 9002

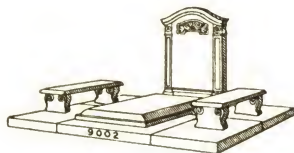

Die.....	4.3 x 1.0 x 5.10..	24.10
Slab.....	8.0 x 4.0 x 0.8..	21.4
4 Legs.....	1.6 x 0.5 x 1.0..	2.8
2 Seats.....	6.0 x 1.9 x 0.3..	5.4
Platform (8 pieces).....	12.0 x 11.0	
D.....	\$1528.00	
F.....	1472.00	
G.....	1445.00	
H.....	1417.00	
I.....	1390.00	
K.....	1349.00	
L.....	1308.00	

No. 9006 1/2

Back.....	7.6 x 0.8 x 3.6..	17.6
Seat.....	6.0 x 1.4 x 0.3..	2.0
2 Supports..	0.4 x 1.3 x 1.1..	0.10
B.Ba. (S.S.)..	7.10 x 3.0 x 0.6..	11.9
Weight complete 5300 lbs.		
D.....	\$475.00	
F.....	455.00	
G.....	445.00	
H.....	435.00	
I.....	424.00	
K.....	409.00	
L.....	394.00	
"M. M." finish		

No. 9003

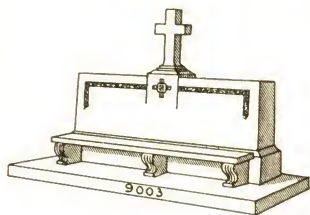

Cross..... 1.8 x 0.8 x 2.10.. 3. 2
 Die.....10.0 x 1.2 x 3. 5..39.10
 Seat & Base..10.6 x 2.8 x 1. 4..37. 4
 B.Ba. (S.S.). 12.0 x 4.0 x 0. 6..24. 0

D.....\$1765.00
 F..... 1685.00
 G..... 1644.00
 H..... 1604.00
 I..... 1563.00
 K..... 1502.00
 L..... 1442.00

"M. M." finish

No. 9004

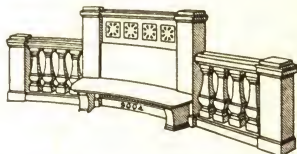

Total height.....4. 6
 Thickness of die.....0.11½
 Height of balustrade.....2.11
 Length across front.....12.9

D.....\$1173.00
 F..... 1127.00
 G..... 1104.00
 H..... 1081.00
 I..... 1058.00
 K..... 1024.00
 L..... 989.00

No. 9005

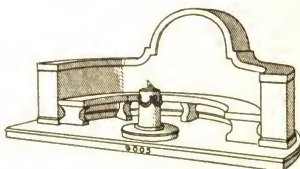

No. 9003¼
 Cross..... 1. 5 x 0.6 x 2.4.. 1.8
 Die..... 8. 6 x 1.0 x 3.4..28.4
 Seat & Base.. 9. 0 x 2.6 x 1.4..30.0
 B.Ba. (S.S.). 10.10 x 3.8 x 0.6..20.0

D.....\$1330.00
 F..... 1270.00
 G..... 1240.00
 H..... 1210.00
 I..... 1180.00
 K..... 1135.00
 L..... 1090.00

"M. M." finish

Total height..... 5. 8
 Thickness of die pieces.. 1. 0
 Height sundial and base. 1.11
 B. Ba. (S.S.).....12.0 x 7. 9

D.....\$3169.00
 F..... 3031.00
 G..... 2962.00
 H..... 2893.00
 I..... 2824.00
 K..... 2721.00
 L..... 2617.00

Bronze sundial not included in above prices.
 "M. M." finish

No. 9006

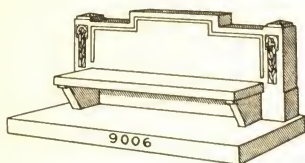

Back.....9.0 x 0.10 x 4.0..30.0
 Seat.....7.2 x 1.5 x 0.4.. 3.4
 2 Supports...0.5 x 1.3 x 1.2.. 1.2
 B.Ba. (S.S.)..9.6 x 3.4 x 0.8..21.2

D.....\$737.00
 F.....703.00
 G.....686.00
 H.....668.00
 I.....651.00
 K.....625.00
 L.....599.00

"M. M." finish

No. 9006 $\frac{1}{4}$

Back.....8.4 x 0.8 x 3.6..19.6
 Seat.....6.10 x 1.4 x 0.3.. 2.3
 2 Supports...0.4 x 1.3 x 1.1.. 0.10
 B.Ba. (S.S.)..8.8 x 3.0 x 0.6..13.0

D.....\$526.00
 F.....504.00
 G.....492.00
 H.....481.00
 I.....470.00
 K.....453.00
 L.....436.00

"M. M." finish

No. 9006 $\frac{1}{2}$

See page 530

No. 9007

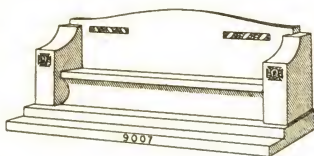

Die.....8.4 x 2.2 x 3.6..63.2
 B.Ba. (S.S.)..8.6 x 3.8 x 0.8..20.10

D.....\$1177.00
 F.....1113.00
 G.....1082.00
 H.....1050.00
 I.....1019.00
 K.....971.00
 L.....924.00

"M. M." finish

No. 9007 $\frac{1}{4}$

Die.....7.4 x 2.0 x 3.6..51.4
 B. Ba. (S.S.)..7.6 x 3.6 x 0.8..17.6

D.....\$961.00
 F.....909.00
 G.....884.00
 H.....858.00
 I.....832.00
 K.....794.00
 L.....755.00

"M. M." finish

No. 9008

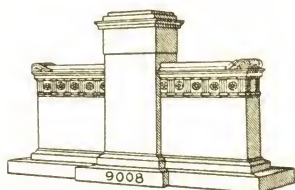

Cap.....	3. 6 x 2.0 x 0. 9..	5.3
Plinth...	3. 0 x 1.7 x 1. 1..	5.2
2 Caps...	4. 11 x 1.5½ x 0.10..	12.4
2 Wings..	4. 8 x 1.2 x 3. 3.	35.4
Die.....	3. 0 x 1.7 x 4. 5.	21.0
Base.....	14. 0 x 3.7 x 1. 2.	58.6

Weight complete 22700 lbs.

D.....	\$2869.00
F.....	2731.00
G.....	2662.00
H.....	2593.00
I.....	2524.00
K.....	2421.00
L.....	2317.00

"M. M." finish

No. 9009

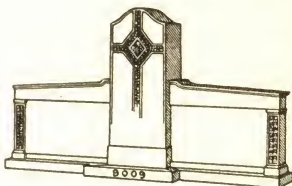

Die.....	2. 8 x 1. 2 x 5. 9..	17.11
Base.....	2.10 x 1. 3 x 0.10..	2.11
2 Wings..	5. 1 x 1. 0 x 3. 9.	38. 2
B. Ba. (S.S.) in three pieces		
1 piece..	4. 2 x 1.10 x 0. 6..	3.10
2 pieces..	4. 4 x 1. 5 x 0. 6..	6. 2

Weight complete 11400 lbs.

D.....	\$1594.00
F.....	1536.00
G.....	1506.00
H.....	1477.00
I.....	1447.00
K.....	1403.00
L.....	1359.00

"M. M." finish

No. 9008¼

Cap.....	2.11 x 1.8 x 0. 7½..	3.3
Plinth...	2. 6 x 1.4 x 0.11 ..	3.1
2 Caps...	4. 1 x 1.3 x 0. 8½..	7.8
2 Wings..	3.11 x 1.0 x 2. 9 ..	21.6
Die.....	2. 6 x 1.4 x 3. 8 ..	12.3
Base.....	11. 8 x 3.0 x 1. 0 ..	35.0

Weight complete 13600 lbs.

D.....	\$2041.00
F.....	1959.00
G.....	1917.00
H.....	1876.00
I.....	1834.00
K.....	1772.00
L.....	1710.00

"M. M." finish

No. 9009¼

Die.....	2. 8 x 1. 0 x 5. 9..	15. 4
Base.....	2.10 x 1. 1 x 0.10..	2. 7
2 Wings..	5. 1 x 0.10 x 3. 9.	31.10
B. Ba. (S.S.) in three pieces		
1 piece..	4. 2 x 1. 7 x 0. 6..	3. 4
2 pieces..	4. 4 x 1. 3 x 0. 6..	5. 6

Weight complete 9600 lbs.

D.....	\$1425.00
F.....	1375.00
G.....	1350.00
H.....	1325.00
I.....	1300.00
K.....	1263.00
L.....	1225.00

"M. M." finish

No. 143

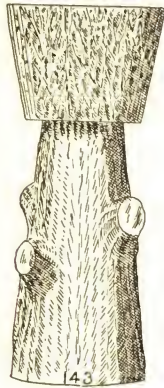

Bowl.....1.4 x 1.4 x 1.0..1.9
 Standard.....1.2 x 1.2 x 2.0..2.9

Weight complete 500 lbs.

Blue.....\$28.00
 P.V., P.I. and Riv.. 23.50
 White..... 20.00

No. 144



Bowl.....1.4 x 1.4 x 1.0..1.9
 Standard.....1.0 x 1.0 x 1.6..1.6
 Base.....1.4 x 1.4 x 0.6..0.11

Weight complete 500 lbs.

Blue.....\$29.00
 P.V., P.I. and Riv.. 24.50
 White..... 21.00

No. 143¹/₄

Bowl.....1.2 x 1.2 x 0.10..1.2
 Standard....1.0 x 1.0 x 1.10..1.10

Weight complete 325 lbs.

Blue.....\$20.25
 P.V., P.I. and Riv.. 17.25
 White..... 15.00

No. 144¹/₄

Bowl....1.2 x 1.2 x 0.10..1.2
 Standard..0.10 x 0.10 x 1.4..0.11
 Base.....1.2 x 1.2 x 0.6..0.8

Weight complete 300 lbs.

Blue.....\$21.25
 P.V., P.I. and Riv.. 18.25
 White..... 16.00

ENTRANCE STEPS

No. 145



3.0 x 0.10 x 0.4.....	\$ 4.25
3.0 x 0.10 x 0.6.....	5.50
3.6 x 0.10 x 0.6.....	6.25
4.0 x 0.10 x 0.6.....	7.00
3.0 x 1. 0 x 0.6.....	6.25
3.6 x 1. 0 x 0.6.....	7.00
4.0 x 1. 0 x 0.6.....	8.25
3.0 x 1. 2 x 0.6.....	7.00
3.6 x 1. 2 x 0.6.....	8.25
4.0 x 1. 2 x 0.6.....	8.75
3.6 x 1. 2 x 0.8.....	10.50
4.0 x 1. 2 x 0.8.....	12.75

No. 146



4.0 x 0.10 x 0.6.....	\$10.75
4.0 x 1. 0 x 0.6.....	12.75
4.0 x 0.10 x 0.8.....	12.75
4.0 x 1. 0 x 0.8.....	14.25

No. 147

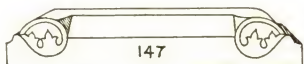

4.0 x 0.10 x 0.6.....	\$11.75
4.0 x 1. 0 x 0.6.....	12.75
4.0 x 0.10 x 0.8.....	13.50
4.0 x 1. 0 x 0.8.....	15.50
5.0 x 0.10 x 0.8.....	15.75
5.0 x 1. 0 x 0.8.....	17.00

The above prices on steps are based upon the grade of Inferior.

GRAVE ENCLOSURES

No. 154

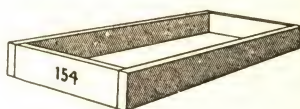

Head Pce.....	2.2 x 0.2 x 0.6..	0.2
2 Sides.....	6.4 x 0.2 x 0.6..	1.0
Foot Pce.....	2.2 x 0.2 x 0.6..	0.2
P. V., P. I. or Rut. White...		\$11.25
Blue.....		12.00

No. 154¹/₄

Head Pce.....	2.0 x 0.2 x 0.6..	0.2
2 Sides.....	4.6 x 0.2 x 0.6..	0.10
Foot Pce.....	2.0 x 0.2 x 0.6..	0.2
P. V., P. I. or Rut. White...		\$10.50
Blue.....		11.00

No. 154¹/₂

Head Pce.....	1.10 x 0.2 x 0.6..	0.2
2 Sides.....	4. 0 x 0.2 x 0.6..	0.8
Foot Pce.....	1.10 x 0.2 x 0.6..	0.2
P. V., P. I. or Rut. White...		\$ 9.75
Blue.....		10.25

No. 155

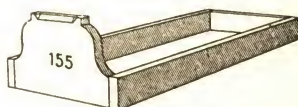

Head Pce.....	2.2 x 0.2 x 1.4..	0.6
2 Sides.....	6.4 x 0.2 x 0.6..	1.0
Foot Pce.....	2.2 x 0.2 x 0.6..	0.2
P. V., P. I. or Rut. White...		\$15.50
Blue.....		16.25

No. 155¹/₄

Head Pce.....	2.0 x 0.2 x 1.4..	0.5
2 Sides.....	4.6 x 0.2 x 0.6..	0.10
Foot Pce.....	2.0 x 0.2 x 0.6..	0.2
P. V., P. I. or Rut. White...		\$14.50
Blue.....		15.00

No. 155¹/₂

Head Pce.....	1.10 x 0.2 x 1.4..	0.5
2 Sides.....	4. 0 x 0.2 x 0.6..	0.8
Foot Pce.....	1.10 x 0.2 x 0.6..	0.2
P. V., P. I. or Rut. White...		\$12.75
Blue.....		13.25

The above prices on grave enclosures are based upon the grade of Inferior. They include drilling of two holes at each joint in each piece.

No. 156



Bowl.....1.10 x 1.10 x 2.9..9.3
 Base.....1.5 x 1.5 x 0.6..1.0

Weight complete 1350 lbs.

C.....	\$171.00
D.....	148.00
F.....	138.00
G.....	133.00
H.....	128.00
I.....	123.00
K.....	115.00
L.....	108.00

Hone finished
 Prices include drilling

No. 156¹/₄

Bowl.....1.6 x 1.6 x 2.6..5.8
 Base.....1.2 x 1.2 x 0.6..0.8

Weight complete 800 lbs.

C.....	\$103.00
D.....	98.50
F.....	92.50
G.....	89.00
H.....	86.00
I.....	83.00
K.....	78.00
L.....	73.50

Hone finished
 Prices include drilling

No. 157

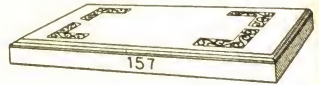

Slab.....6.0 x 3.0 x 0.6..9.0

Weight complete 1600 lbs.

C.....	\$164.00
D.....	144.00
F.....	135.00
G.....	130.00
H.....	126.00
I.....	121.00
K.....	114.00
L.....	108.00

Grit finished

No. 158

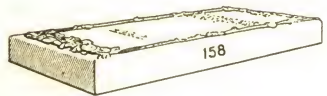

Slab.....6.6 x 3.0 x 0.8..13.0

Weight complete 2300 lbs.

C.....	\$381.00
D.....	352.00
F.....	339.00
G.....	332.00
H.....	326.00
I.....	319.00
K.....	309.00
L.....	300.00

Hone finished

No. 159



Vase.....2.6 x 2.6 x 2.2..13.7
Weight complete 1700 lbs.

F.....	177.00
G.....	170.00
H.....	164.00
I.....	157.00
K.....	147.00
L.....	136.00
Sand finished	

No. 159¹/₄

Vase.....2.0 x 2.0 x 1.10..7.4
Weight complete 950 lbs.

F.....	119.00
G.....	116.00
H.....	112.00
I.....	108.00
K.....	103.00
L.....	97.50
Sand finished	

No. 159¹/₂

Vase.....1.10 x 1.10 x 1.8..5.7
Weight complete 750 lbs.

F.....	96.50
G.....	94.00
H.....	91.00
I.....	88.50
K.....	84.00
L.....	80.00
Sand finished	

No. 159³/₄

Vase.....1.8 x 1.8 x 1.6..4.2
Weight complete 600 lbs.

F.....	78.50
G.....	76.50
H.....	74.50
I.....	72.00
K.....	69.00
L.....	66.00
Sand finished	

No. 160

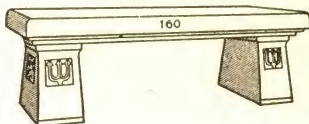

Seat.....5.0 x 1.10 x 0.5..3.10
2 Legs.....0.8 x 1.6 x 1.3..2.6
Weight complete 1000 lbs.
Rutland White,
Riv., S. F., Blue
or P. V.....\$85.50
Sand finished

No. 160¹/₄

Seat.....4.6 x 1.8 x 0.4..2.6
2 Legs.....0.6 x 1.4 x 1.3..1.8
Weight complete 700 lbs.
Rutland White,
Riv., S. F., Blue
or P. V.....\$72.00
Sand finished

No. 161

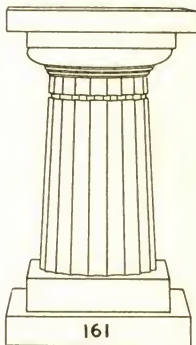

Top.....1.8¹/₂ x 1.8¹/₂ x 0.2¹/₄..0.6
Cap.....1.4 x 1.4 x 0.4¹/₂..0.9
Col.....1.1 x 1.1 x 1.9..2.1
Base.....1.3¹/₂ x 1.3¹/₂ x 0.3..0.5
Base.....1.8 x 1.8 x 0.4..0.11
Weight complete 700 lbs.

C.....	\$91.00
D.....	80.50
F.....	75.50
G.....	73.50
H.....	71.00
I.....	68.50
K.....	65.00
L.....	61.50
Grit finished	

Prices on above sundial pedestal do not include metal dial.

No. 162

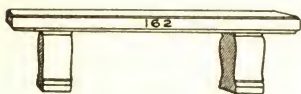

Seat.....6.0 x 1.6 x 0.4..3.0
 2 Legs.....0.7 x 1.3 x 1.4..2.0

Weight complete 850 lbs.

Rutland White,
 Riv., S. F., Blue
 or P. V.....\$49.50

Sand finished

No. 164

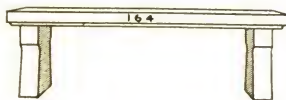

Seat.....5.0 x 1.4 x 0.3..1.8
 2 Legs.....1.1 x 0.4 x 1.3..0.10

Weight complete 450 lbs.

Rutland White,
 Riv., S. F., Blue
 or P. V.....\$26.00

Sand finished

No. 163

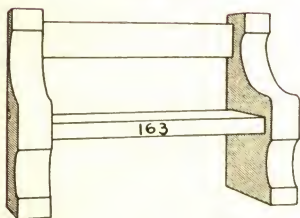

Back.....3.7 x 0.2 x 0.7..0.4
 Seat.....3.7 x 1.6 x 0.3..1.4
 2 Ends.....0.6 x 1.10 x 3.0..5.6

Weight complete 1000 lbs.

Rutland White,
 Riv., S. F., Blue
 or P. V.....\$52.00

Sand finished

No. 165

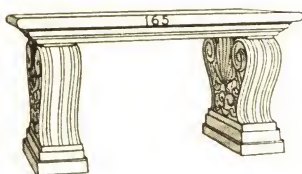

Seat.....4.0 x 1.8 x 0.3..1.8
 2 Legs.....0.6 x 1.5 x 1.3..1.10

Weight complete 550 lbs.

C.....\$159.00
 D.....151.00
 F.....147.00
 G.....146.00
 H.....144.00
 I.....142.00
 K.....139.00
 L.....137.00

Polished. If sand finished deduct \$13.50

No. 166



Seat.....4.6 x 1.2 x 0.2 .0.11
 2 Legs.....1.0 x 0.4 x 1.3 .0.10

Weight complete 315 lbs.

Rutland White,
 Riv., S. F., Blue
 or P. V.....\$23.00.

Sand finished

No. 167



Vase.....1.8 x 1.8 x 1.6 .4.2

Weight complete 500 lbs.

Rutland White,
 Riv., S. F., Blue
 or P. V.....\$53.00

Sand finished

No. 168



Vase.....1.10 x 1.10 x 1.7 .5.4

Weight complete 625 lbs.

Rutland White,
 Riv., S. F., Blue
 or P. V.....\$47.00

Sand finished

No. 169

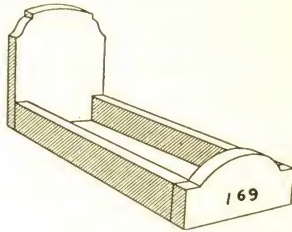

Die.....2.0 x 0.4 x 2.6 .1.8
 2 Sides.....5.1 x 0.3 x 0.8 .1.8
 End.....2.0 x 0.3 x 1.0 .0.6

Weight complete 600 lbs.

Headstone L. stock

Foot and side pieces \$4.25 stock

Price.....\$30.00

No. 170

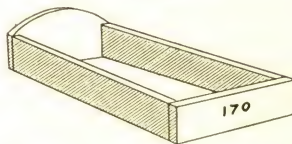

Head Pce.....2.0 x 0.2 x 1.0 .0.4
 2 Sides.....4.8 x 0.2 x 0.8 .1.0
 End.....2.0 x 0.2 x 0.8 .0.3

Weight complete 250 lbs.

Headstone L. stock

Foot and side pieces \$4.25 stock

Price.....\$10.00

No. 171

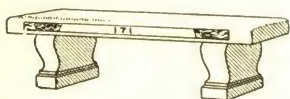

Seat.....6.0 x 1.8 x 0.4..3.4
2 Legs.....0.6 x 1.6 x 1.1..1.8

Weight complete 875 lbs.

Rutland White,
Riv., S. F., Blue
or P. V.....\$109.00

No. 173

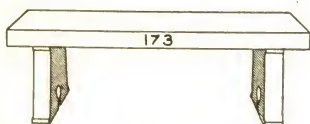

Seat.....4.0 x 1.4 x 0.3..1.4
2 Legs.....1.4 x 0.3 x 1.1..0.8

Weight complete 350 lbs.

Rutland White,
Riv., S. F., Blue
or P. V.....\$28.00

No. 172

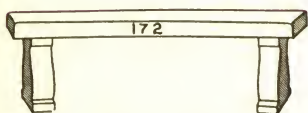

Seat.....5.0 x 1.8½ x 0.3..2.2
2 Legs.....1.2 x 0.4 x 1.2..0.10

Weight complete 525 lbs.

Rutland White,
Riv., S. F., Blue
or P. V.....\$45.00

No. 5898

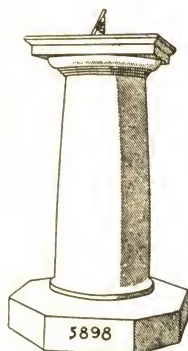

Cap.....1.5 x 1.5 x 0.4½..0.10
Col.....1.2 x 1.2 x 2.6..3.5
Base.....1.11 x 1.11 x 0.5..1.6

Weight complete 900 lbs.

Rutland White,
Riv., S. F., Blue
or P. V.....\$48.50

Sand finished
Price on above sundial pedestal does not
include metal dial.

Plain Headstones

Square, Round, Bevel, Ogee, Apex and Oval Tops, Finished, Boxed and on cars.

FACE, EDGES AND TOP POLISHED, BACKS SAND FINISHED

1.0 x 2.0 and larger

Price per cubic foot

STOCK	2-inch	3-inch	4-inch
RUTLAND WHITE			
Average.....	\$17.50	\$16.50	\$15.50
No. 2.....	15.25	14.25	13.25
Light Rutland Italian.....	15.25	14.25	13.25
Rutland Italian.....	13.75	12.75	11.75
Best No. 3.....	12.75	11.75	10.75
No. 3 Rutland.....	11.25	10.25	9.25
VERMONT BLUE			
Extra Dark Blue.....	\$14.25	\$13.25	\$12.25
“ “ Vein.....	13.25	12.25	11.25
Dark Vein.....	12.00	11.00	10.00
Standard Blue.....	11.25	10.25	9.25
PITTSFORD VALLEY AND BRANDON ITALIAN			
Average.....	\$12.75	\$11.75	\$10.75
No. 2.....	12.00	11.00	10.00
Best No. 3.....	11.25	10.25	9.25
SUTHERLAND FALLS, PITTSFORD ITALIAN AND RIVERSIDE			
No. 1.....	\$15.25	\$14.25	\$13.25
Average.....	14.25	13.25	12.25
No. 2.....	12.75	11.75	10.75
Best No. 3.....	11.25	10.25	9.25

Headstones smaller than 1.0 x 2.0 extra per cu. ft. \$1.50

If Headstones with rough tops are wanted, deduct 50 cents per cubic foot from above prices.

If Headstones with glossed backs are wanted, add 20 cents per surface foot to above prices.

Deduct for grit finish 15 cents per surface foot.

Miscellaneous

Mortises—

Bottom Bases 1.6 long and smaller each \$1.35
 “ “ over 1.6 long “ 1.75

Tenons—

Shoulder “ .75
 Full “ 1.25

Drilling—

Holes ½ to ¾ in., drilled 2 to 3 in. deep—Posts or Coping “ .20
 Holes ½ to ¾ in., drilled 2 to 3 in. deep—Markers, Dies or Bottom Bases “ .10
 Holes 1 to 2 in., drilled 2½ to 3 in. deep—Posts or Coping “ .30

Holes drilled through Posts, double the above prices

FOR POST DESIGNS SEE PAGE 546

Marker Designs

No. 1

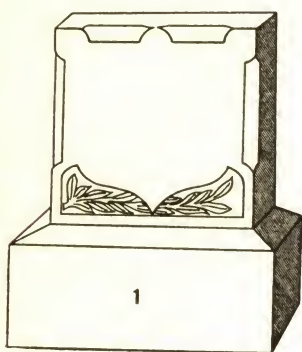

No. 5

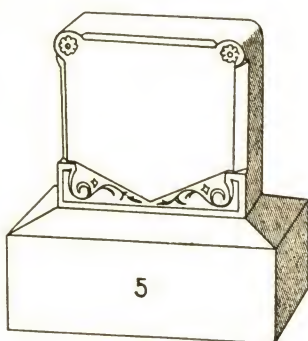

No. 2

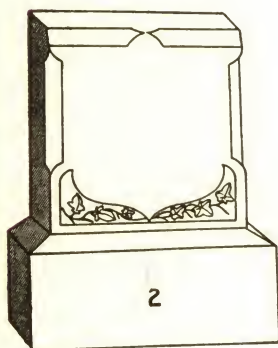

No. 6

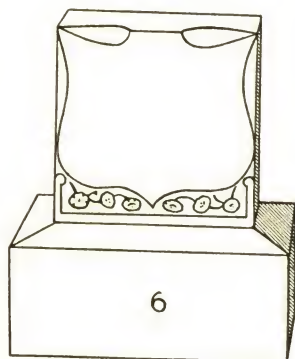

No. 4

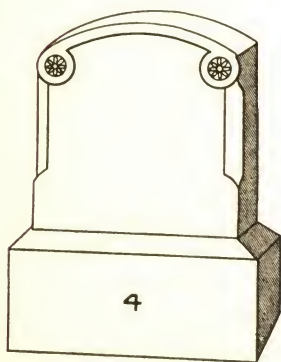

No. 7

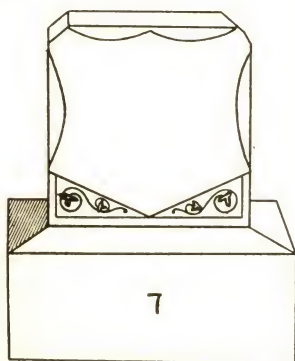

Marker Designs

No. 8

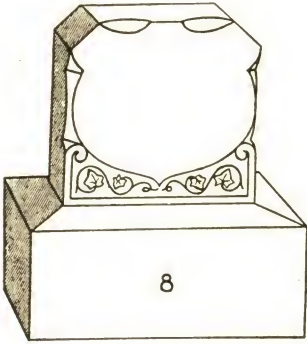

No. 13

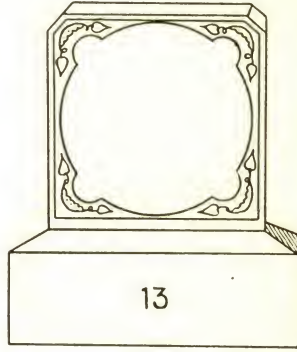

No. 10

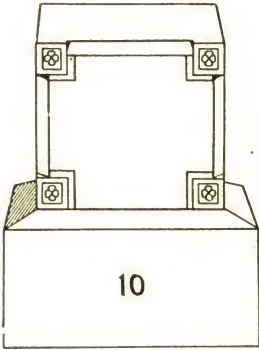

No. 14

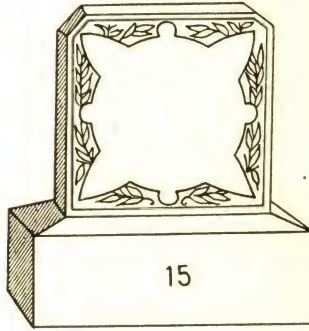

No. 12

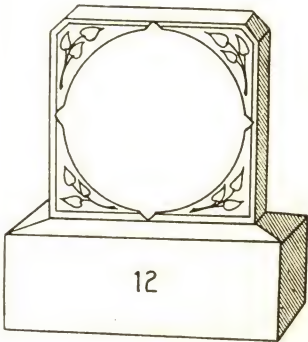

No. 15

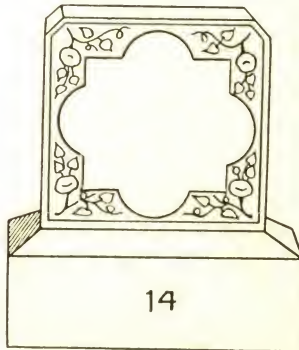

Markers

DESIGNS Nos. 1, 2, 4, 5, 6, 7, 8, 10, 12, 13, 14, 15

See previous pages

Die.....0.10 x 0. 4 x 0.10	0. 3.....}	} each \$ 6.25
B. B.....1. 2 x 0. 8 x 0. 6	0. 5.....}	
Die.....0.10 x 0. 6 x 0.10	0. 4.....}	} each 8.00
B. B.....1. 2 x 0.10 x 0. 6	0. 6.....}	
Die.....1. 0 x 0. 4 x 1. 0	0. 4.....}	} each 8.25
B. B.....1. 4 x 0. 8 x 0. 6	0. 5.....}	
Die.....1. 2 x 0. 4 x 1. 2	0. 5.....}	} each 10.25
B. B.....1. 6 x 0. 8 x 0. 8	0. 8.....}	
Die.....1. 0 x 0. 6 x 1. 0	0. 6.....}	} each 11.50
B. B.....1. 4 x 0.10 x 0. 6	0. 7.....}	
Die.....1. 2 x 0. 6 x 1. 2	0. 8.....}	} each 14.75
B. B.....1. 6 x 0.10 x 0. 8	0.10.....}	

Markers

Order by letter as shown on photograph in Design Book "M"

"A," "C," "D" and "F," regular prices, page 545 of the List.

"B" extra each.....	\$.30
"H" " " ".....	.60
"E" " " ".....	.75
"G" " " ".....	1.25

Those showing raised letters will be finished with raised band

Finished Markers

With Plain Oval Tops or Square Tops Beveled to Front

Width	Thickness	Height	STOCK—See Index page 16					
			D.	G.	H.	I.	K.	L.
0.10x0.3x0.10			\$3.75	\$3.50	\$3.40	\$3.35	\$3.20	\$3.10
0.10x0.3x1.2			4.55	4.15	4.00	3.90	3.70	3.50
1.0x0.3x0.10			4.55	4.15	4.00	3.90	3.70	3.50
1.0x0.3x1.0			5.00	4.60	4.45	4.35	4.15	3.95
1.0x0.3x1.2			5.60	5.10	4.95	4.75	4.50	4.25
1.0x0.3x1.4			5.95	5.45	5.30	5.10	4.85	4.60
1.2x0.3x1.4			6.75	6.10	5.90	5.70	5.35	5.05
1.2x0.3x1.6			7.05	6.40	6.20	6.00	5.65	5.35
0.10x0.4x0.10			4.45	4.05	3.90	3.80	3.60	3.40
0.10x0.4x1.0			4.85	4.45	4.30	4.20	4.00	3.80
1.0x0.4x0.8			4.80	4.40	4.25	4.15	3.95	3.75
1.0x0.4x0.10			4.85	4.45	4.30	4.20	4.00	3.80
1.0x0.4x1.0			5.70	5.20	5.05	4.85	4.60	4.35
1.0x0.4x1.2			6.50	5.85	5.65	5.45	5.10	4.80
1.0x0.4x1.4			6.95	6.30	6.10	5.90	5.55	5.25
1.2x0.4x1.0			6.50	5.85	5.65	5.45	5.10	4.80
1.2x0.4x1.2			7.05	6.40	6.20	6.00	5.65	5.35
1.2x0.4x1.4			7.95	7.20	6.95	6.70	6.30	5.95
1.2x0.4x1.6			8.90	8.00	7.70	7.40	7.00	6.55
1.0x0.5x1.0			6.65	6.00	5.80	5.60	5.25	4.95
1.2x0.5x1.2			8.90	8.00	7.70	7.40	7.00	6.55
1.0x0.6x0.10			6.75	6.10	5.90	5.70	5.35	5.05
1.0x0.6x1.0			8.10	7.35	7.10	6.85	6.45	6.10
1.0x0.6x1.2			9.05	8.15	7.85	7.55	7.15	6.70
1.2x0.6x1.2			9.95	8.95	8.60	8.30	7.80	7.30
1.2x0.6x1.4			11.00	9.85	9.45	9.10	8.55	7.95

Bottom Bases for the above, sand finished see page 16

MARKERS TO SET IN GROUND

With Plain Oval Tops, or Square Tops Beveled to Front. Top, Face and Edges Polished One-Half Way Down. Backs Sand Finished

0.8x0.2x1.8	0.2	each	\$2.55
0.8x0.2x2.0	0.3	"	3.05
0.10x0.2x1.8	0.3	"	3.20
0.10x0.2x2.0	0.3	"	3.40
0.10x0.3x1.8	0.4	"	3.50
0.10x0.3x2.0	0.5	"	4.10
1.0x0.3x1.8	0.5	"	4.10
1.0x0.3x2.0	0.6	"	4.60
0.10x0.4x1.8	0.6	"	4.60
0.10x0.4x2.0	0.7	"	5.05
1.0x0.4x1.8	0.7	"	5.05
1.0x0.4x2.0	0.8	"	5.65
1.2x0.4x2.0	0.9	"	6.60
1.0x0.6x1.8	0.10	"	7.25
1.0x0.6x2.0	1.0	"	8.50
1.2x0.6x1.8	1.0	"	8.50
1.2x0.6x2.0	1.2	"	9.45

Markers containing less than 0.6 cubic ordered boxed singly, extra each \$.20

Markers with square tops deduct 25c.

Markers, oval top, bevel to front " " .30

Markers with band on top " " .75

Ground Markers with polished backs " " .30

Markers with edges sand finished, deduct: 2 in., 25c.; 3 in., 30c.; 4 and 5 in., 40c.; 6 in., 50c.

Designs for Coping and Posts

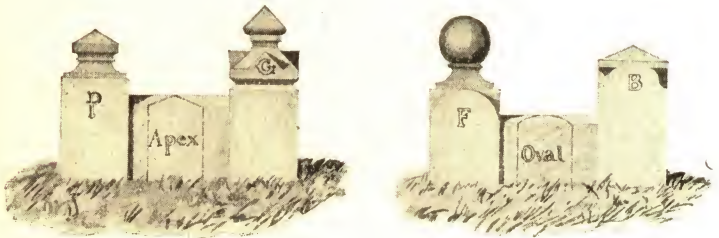

For Prices on above see Page 547

Coping

Sand Finished and Crated

Per Cubit Foot

	4 Inches Wide	5 Inches Wide	6 Inches Wide	8 and 10 Inches Wide
Oval Top	\$6.00	\$5.75	\$5.45	\$5.10
Apex Top	5.60	5.40	5.30	4.85
Bevel Top	5.30	5.05	4.85	4.55
Ogee Top	6.20	6.05	5.75	5.35
Design X	6.80	6.45	6.20	5.65
Designs Y and Z	7.20	6.90	6.45	6.05

In lengths 8.1 to 8.11 add per cubic foot \$.35

For every additional foot or fraction thereof in length " " " " .35

The above prices for Copings are based upon the grade of Inferior Rutland, Pittsford Valley or Pittsford Italian. If in Inferior Blue, extra per cubic foot, 35 cents.

For price in other grades add difference in cost of stock.

For Coping designs see page 546

Posts

Inferior Stock, Plain Square Tops, Sand Finished and Crated, per cubic foot, \$3.40

SPECIAL TOPS EXTRA, EACH POST AS GIVEN BELOW

Design	Inches Square						
	4 in.	5 in.	6 in.	7 in.	8 in.	10 in.	12 in.
Apex or Oval One Way	\$.25	\$.30	\$.45	\$.60	\$.80	\$1.15	\$1.50
Bevel or Square with Chamfer B20	.25	.35	.50	.60	.90	1.15
C, D, E, F, U and M			1.25	1.75	1.85	2.40	3.00
G and P			1.85	2.45	3.00	3.35	3.80
I			4.80	5.60	6.80	7.50	9.60
J (Post only—to fit vase)					9.60	12.00	15.00
R					3.80	5.30	6.80
S, T and W			1.85	2.45	3.00	3.80	5.30
V (Post only—to fit vase)			3.35	3.80	4.50	5.30	6.35
			1.50	1.85	2.45	3.00	3.35

Cemetery Vases

Sand Finished and Boxed

Des. V, where diameter of Bowl is 1.0 or more per cu. ft. \$ 9.00

Des. J, where diameter of Bowl is 1.0 or more " " " 11.50

Burial Vaults



These vaults are made of sawed Inferior Rutland Marble Slabs, two inches thick, fitted ready to set, as shown in cut, delivered on board cars at Proctor, Vt.

Inside Dimensions

No.	Weight	Length	Depth	Width	Cu.	Price Not Crated	Price Crated
1	600 lbs.	3.0	1.0	1.4	3.4	\$13.50	\$15.50
2	900 "	4.0	1.2	1.6	5.0	19.00	22.00
3	1,350 "	5.0	1.4	1.10	7.2	25.50	30.00
4	1,600 "	6.0	1.6	1.10	8.10	30.50	35.50
5	1,800 "	6.6	1.10	2.2	10.0	34.50	40.50
6	2,050 "	7.0	1.8	2.2	11.4	38.50	45.50
7	2,200 "	7.0	1.9	2.4	12.2	41.00	48.50
8	2,400 "	7.2	2.0	2.4	13.4	44.50	52.50
9	2,350 "	7.0	1.10	2.6	12.10	43.00	51.00
10	2,650 "	7.4	2.0	2.8	14.8	49.00	58.00

The best vault made. Kept in stock ready for immediate shipment at all times.

No. 1333



1333

Urn 1333.....1.4 x 1.4 x 3.0
Rutland Italian.....\$118.00

Prices in other kinds and grades vary only in cost of stock.

No. 3269

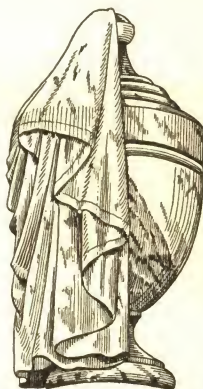

Urn 3269.....1.0 x 1.0 x 2.0
Price in Rutland Italian....\$66.00

Urn 3269½.....0.10 x 0.10 x 1.10
Price in Rutland Italian....\$53.00

Prices in other kinds and grades vary only in cost of stock.

No. 3234

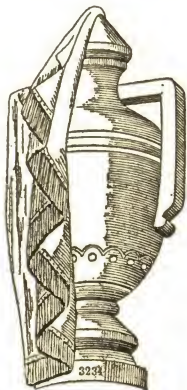

3234

Urn 3234.....0.11 x 0.11 x 2.2
Rutland Italian.....\$69.50

Urn 3234½.....0.9 x 0.9 x 1.10
Rutland Italian.....\$52.00

Prices in other kinds and grades vary only in cost of stock.

No. 3592

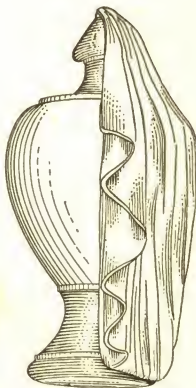

Urn 3592.....0.9 x 0.9 x 1.6
Price in Rutland Italian....\$36.75

Urn 3592½.....0.8 x 0.8 x 1.5
Price in Rutland Italian....\$29.50

Urn 3592¾.....0.7 x 0.7 x 1.4
Price in Rutland Italian....\$25.50

Prices in other kinds and grades vary only in cost of stock.

Price List of Urns

Height in Inches		STOCK—See Index page 16						Diameter of Bowl		Height in Inches	
Diameter of Bowl		F.	G.	H.	I.	K.	L.	Diameter of Bowl		Height in Inches	
7	4	\$ 5.00	\$ 4.95	\$ 4.90	\$ 4.85	\$ 4.80	\$ 4.75	4	7		
8	5	5.35	5.30	5.25	5.20	5.15	5.10	5	8		
9	5	5.40	5.35	5.30	5.25	5.20	5.15	5	9		
10	5	5.70	5.60	5.55	5.45	5.30	5.20	5	10		
10	6	6.15	6.00	5.90	5.75	5.60	5.40	6	10		
12	6	7.15	7.00	6.90	6.75	6.60	6.40	6	12		
13	6	7.60	7.45	7.35	7.20	7.05	6.85	6	13		
14	6	7.85	7.70	7.50	7.35	7.15	6.95	6	14		
12	7	8.35	8.20	8.00	7.85	7.60	7.35	7	12		
13	7	8.80	8.65	8.45	8.30	8.05	7.80	7	13		
14	7	9.05	8.85	8.65	8.40	8.15	7.90	7	14		
15	7	9.40	9.20	9.00	8.75	8.45	8.15	7	15		
16	7	9.90	9.70	9.50	9.25	8.95	8.65	7	16		
14	8	11.30	11.05	10.80	10.55	10.15	9.80	8	14		
15	8	11.55	11.25	10.95	10.65	10.25	9.90	8	15		
16	8	11.85	11.55	11.25	10.95	10.55	10.10	8	16		
18	8	12.30	11.95	11.65	11.30	10.80	10.30	8	18		
16	9	13.35	12.95	12.60	12.20	11.65	11.10	9	16		
17	9	13.80	13.40	12.95	12.55	11.90	11.30	9	17		
18	9	14.45	14.05	13.60	13.20	12.55	11.95	9	18		
20	9	15.35	14.90	14.45	13.95	13.30	12.60	9	20		
18	10	16.50	15.95	15.40	14.85	14.05	13.25	10	18		
20	10	17.75	17.15	16.60	16.00	15.10	14.25	10	20		
22	10	18.95	18.30	17.70	17.05	16.15	15.20	10	22		
24	10	19.80	19.10	18.40	17.65	16.60	15.55	10	24		
20	11	21.10	20.40	19.70	18.95	17.90	16.85	11	20		
22	11	22.35	21.60	20.85	20.10	18.95	17.85	11	22		
24	11	23.40	22.55	21.75	20.90	19.65	18.40	11	24		
20	12	24.45	23.60	22.80	21.95	20.70	19.45	12	20		
22	12	25.45	24.55	23.60	22.70	21.30	19.95	12	22		
24	12	26.75	25.75	24.75	23.75	22.25	20.75	12	24		
26	12	27.75	26.65	25.60	24.50	22.85	21.25	12	26		
28	12	28.90	27.75	26.55	25.40	23.65	22.15	12	28		
24	13	30.05	28.90	27.70	26.55	24.80	23.30	13	24		
26	13	31.50	30.20	28.90	27.60	25.70	23.75	13	26		
28	13	33.30	31.90	30.55	29.15	27.10	25.05	13	28		
24	14	37.00	35.60	34.25	32.85	30.80	28.75	14	24		
28	14	41.85	40.25	38.70	37.10	34.70	32.35	14	28		
30	14	43.75	42.05	40.35	38.60	36.05	33.50	14	30		

Design	FINIALS STOCK—See Index page 16				
	G.	H.	I.	K.	L.
4957					
1. 2x0.5x1.8	\$16.75	\$16.35	\$15.90	\$15.30	\$14.65
1. 0x0.4x1.6	12.00	11.75	11.50	11.10	10.75
0.10x0.4x1.4	10.00	9.85	9.65	9.40	9.15
4628					
1. 0x0.5x1.6	14.50	14.15	13.85	13.35	12.85
0.10x0.4x1.4	10.00	9.85	9.65	9.40	9.15
0. 9x0.4x1.4	9.75	9.60	9.40	9.15	8.90

Price List of Balls

Diameter of Ball	STOCK—See Index page 16						Diameter of Ball
	F.	G.	H.	I.	K.	L.	
0. 5	\$ 4.20	\$ 4.15	\$ 4.10	\$ 4.05	\$ 4.00	\$ 3.95	0. 5
0. 6	4.80	4.70	4.65	4.55	4.40	4.30	0. 6
0. 7	5.70	5.60	5.55	5.45	5.30	5.20	0. 7
0. 8	6.55	6.40	6.20	6.05	5.80	5.55	0. 8
0. 9	7.45	7.25	7.05	6.80	6.50	6.20	0. 9
0.10	9.40	9.10	8.80	8.50	8.10	7.65	0.10
0.11	11.30	10.90	10.55	10.15	9.60	9.05	0.11
1. 0	13.25	12.75	12.25	11.75	11.00	10.25	1. 0
1. 2	18.95	18.15	17.35	16.55	15.40	14.20	1. 2
1. 4	28.35	27.20	26.00	24.85	23.10	21.35	1. 4
1. 6	39.70	37.00	36.30	34.55	32.00	29.45	1. 6
1. 8	52.90	50.55	48.25	45.90	42.40	38.90	1. 8
1.10	66.00	62.90	59.85	56.75	52.10	47.50	1.10
2. 0	81.00	77.00	73.00	69.00	63.00	57.00	2. 0

Design	BALLS WITH PLINTHS						Diameter	Height
7240	\$24.45	\$23.60	\$22.80	\$21.95	\$20.70	\$19.45	1. 0	1. 8
7240 $\frac{1}{4}$	16.50	15.95	15.40	14.85	14.05	13.25	0.10	1. 6
7240 $\frac{1}{2}$	11.85	11.55	11.25	10.95	10.55	10.10	0. 8	1. 4
7240 $\frac{3}{4}$	7.85	7.70	7.50	7.35	7.10	6.85	0. 6	1. 2
28	31.50	30.25	29.00	27.75	25.75	24.00	1. 2	1.10
28 $\frac{1}{4}$	21.75	21.00	20.00	19.25	18.25	17.00	1. 0	1. 7

Price List of Rolls

With plain polished ends

SIZES	STOCK—See Index page 16						
	D.	F.	G.	H.	I.	K.	L.
1. 2x0. 6x0. 6 .	\$ 6.50	\$ 6.20	\$ 6.00	\$ 5.85	\$ 5.70	\$ 5.45	\$ 5.20
1. 4x0. 7x0. 7 .	7.85	7.45	7.25	7.00	6.80	6.50	6.00
1. 4x0. 8x0. 8 .	9.65	9.05	8.75	8.45	8.20	7.75	7.30
1. 6x0. 8x0. 8 .	10.85	10.15	9.85	9.50	9.15	8.65	8.15
1. 8x0. 8x0. 8 .	12.05	11.25	10.90	10.50	10.15	9.60	9.00
1. 6x0. 9x0. 9 .	12.70	11.90	11.45	11.05	10.65	10.00	9.40
1. 8x0. 9x0. 9 .	13.90	12.90	12.50	12.00	11.55	10.90	10.20
1. 6x0. 10x0. 10 .	15.85	14.75	14.20	13.65	13.15	12.30	11.50
1. 8x0. 10x0. 10 .	16.95	15.75	15.20	14.60	14.00	13.15	12.25
1.10x0. 10x0. 10 .	18.10	16.80	16.20	15.55	14.95	14.00	13.05
2. 0x0. 10x0. 10 .	20.25	18.85	18.15	17.40	16.70	15.65	14.60
2. 4x0. 10x0. 10 .	22.50	20.90	20.10	19.30	18.55	17.35	16.15
1.10x1. 0x1. 0 .	25.40	23.60	22.65	21.75	20.85	19.45	18.10
2. 0x1. 0x1. 0 .	27.55	25.55	24.55	23.55	22.55	21.05	19.55
2. 2x1. 0x1. 0 .	30.75	29.55	28.50	27.40	26.30	24.70	23.05
2. 4x1. 2x1. 2 .	41.90	38.70	37.15	35.55	33.75	31.55	29.20

Rolls with rocked and margined ends will be furnished at the same price as above, but solid lengths will be two inches less than length given.

Ornamental Crosses

Finished per design

SIZES		STOCK—See Index page 16					
		D.	G.	H.	I.	K.	L.
No. 657	1. 2x0.4x1. 8	\$17.50	\$16.50	\$16.15	\$15.85	\$15.35	\$14.85
“ 657 $\frac{1}{4}$	1. 1x0.4x1. 6	15.55	14.65	14.35	14.05	13.65	13.20
“ 3152	1. 2x0.5x1. 8	18.90	17.65	17.25	16.80	16.20	15.55
“ 3152 $\frac{1}{4}$	1. 0x0.4x1. 6	12.50	11.75	11.50	11.25	10.85	10.50
“ 3152 $\frac{1}{2}$	0.10x0.3x1. 2	8.65	8.25	8.10	8.00	7.80	7.60
“ 3291 $\frac{1}{4}$	1. 1x0.4x1. 6	13.55	12.65	12.35	12.05	11.65	11.20
“ 3291 $\frac{1}{2}$	1. 0x0.3x1. 4	10.05	9.55	9.40	9.20	8.95	8.70
“ 3496	1. 0x0.4x1. 4	13.55	12.90	12.70	12.50	12.15	11.85
“ 3496 $\frac{1}{4}$	0.10x0.4x1. 2	11.30	10.80	10.65	10.45	10.20	9.95
“ 3496 $\frac{1}{2}$	0.10x0.3x1. 2	9.90	9.50	9.35	9.25	9.05	8.85
“ 3496 $\frac{3}{4}$	0. 8x0.2x1. 0	8.00	7.85	7.80	7.75	7.70	7.65
“ 3554	1. 2x0.5x1. 8	22.15	20.90	20.50	20.05	19.45	18.80
“ 3554 $\frac{1}{4}$	1. 1x0.4x1. 6	15.80	14.90	14.60	14.30	13.85	13.45
“ 3586	1. 2x0.6x1. 8	47.70	46.20	45.70	45.20	44.45	43.70
“ 3586 $\frac{1}{4}$	1. 1x0.5x1. 6	40.15	39.15	38.80	38.50	38.00	37.50
“ 3587	1. 2x0.5x1. 8	21.40	20.15	19.75	19.30	18.70	18.05
“ 3587 $\frac{1}{4}$	1. 0x0.4x1. 6	14.50	13.75	13.50	13.25	12.85	12.50
“ 3587 $\frac{1}{2}$	0.10x0.3x1. 4	11.30	10.80	10.65	10.45	10.20	9.95
“ 3705	1. 3x0.5x1.10	22.35	20.95	20.50	20.05	19.35	18.65
“ 3705 $\frac{1}{4}$	1. 2x0.4x1. 8	17.65	16.65	16.30	16.00	15.50	15.00
“ 3729	0.10x0.3x1. 2	11.35	10.95	10.80	10.70	10.50	10.30
“ 3729 $\frac{1}{4}$	1. 0x0.4x1. 4	15.40	14.75	14.55	14.35	14.00	13.70
“ 3729 $\frac{1}{2}$	0.10x0.2x1. 2	10.35	10.10	10.00	9.95	9.80	9.70
“ 4450	1. 0x0.4x1. 6	13.75	13.00	12.75	12.50	12.10	11.75
“ 4450 $\frac{1}{4}$	0.10x0.3x1. 2	9.80	9.40	9.25	9.15	8.95	8.75
“ 4450 $\frac{1}{2}$	0. 8x0.2x1. 0	7.90	7.75	7.70	7.65	7.60	7.55
“ 4534	1. 2x0.5x1. 8	20.80	19.55	19.15	18.70	18.10	17.45
“ 4534 $\frac{1}{4}$	1. 0x0.4x1. 6	14.40	13.65	13.40	13.15	12.75	12.40
“ 4534 $\frac{1}{2}$	0.10x0.3x1. 3	10.90	10.50	10.35	10.25	10.05	9.85
“ 4827	1. 2x0.6x1.10	29.35	27.70	27.15	26.60	25.80	25.00
“ 4827 $\frac{1}{4}$	1. 2x0.5x1. 8	23.30	22.05	21.65	21.20	20.60	19.95
“ 4827 $\frac{1}{2}$	1. 0x0.4x1. 6	17.00	16.25	16.00	15.75	15.35	15.00
“ 4882	1. 2x0.4x1. 8	25.20	24.20	23.85	23.55	23.05	22.55
“ 4882 $\frac{1}{4}$	1. 0x0.3x1. 4	20.05	19.55	19.40	19.20	18.95	18.70
“ 6519	1. 6x0.6x2. 0	37.20	34.95	34.20	33.45	32.30	31.20
“ 6519 $\frac{1}{4}$	1. 4x0.5x1.10	28.95	27.45	26.95	26.45	25.70	24.95
“ 6519 $\frac{1}{2}$	1. 2x0.4x1. 8	22.65	21.65	21.30	21.00	20.50	20.00
“ 6528	1. 6x0.6x2. 0	54.70	52.45	51.70	50.95	49.80	48.70
“ 6528 $\frac{1}{4}$	1. 4x0.5x1.10	45.20	43.70	43.20	42.70	41.95	41.20
“ 6528 $\frac{1}{2}$	1. 2x0.4x1. 8	40.15	39.15	38.80	38.50	38.00	37.50

Crucifix Crosses

Plain square crosses with carved crucifix

0. 8x0.3x1. 0	.	.	\$20.00	\$19.75	\$19.65	\$19.60	\$19.45	\$19.35
0.10x0.3x1. 2	.	.	22.30	21.90	21.75	21.65	21.45	21.25
0.10x0.4x1. 2	.	.	23.80	23.30	23.15	22.95	22.70	22.45
1. 0x0.4x1. 4	.	.	28.50	27.85	27.65	27.45	27.10	26.80
1. 2x0.5x1. 8	.	.	36.40	35.15	34.75	34.30	33.70	33.05
1. 4x0.6x1.10	.	.	42.55	40.65	40.00	39.40	38.45	37.50

N. B. For prices on plain square crosses with traced crucifix, see design 3496 above

Plain Square Crosses

All polished

SIZES	Con- tents	STOCK—See Index page 16						
		D.	F.	G.	H.	I.	K.	L.
0. 7x0.2x0.10	0. 1	\$ 5.35	\$ 5.25	\$ 5.20	\$ 5.15	\$ 5.15	\$ 5.05	\$ 5.00
0. 8x0.2x1. 0	0. 1	5.60	5.50	5.45	5.40	5.40	5.30	5.25
0.10x0.2x1. 4	0. 2	6.25	6.10	6.05	5.95	5.85	5.75	5.60
0. 8x0.3x1. 0	0. 2	6.25	6.10	6.05	5.95	5.85	5.75	5.60
0.10x0.3x1. 2	0. 3	7.40	7.15	7.05	6.90	6.80	6.60	6.40
0.10x0.3x1. 4	0. 3	7.80	7.55	7.45	7.30	7.20	7.00	6.80
1. 0x0.3x1. 4	0. 4	8.55	8.20	8.00	7.85	7.70	7.45	7.20
1. 0x0.3x1. 6	0. 5	9.00	8.60	8.40	8.15	7.95	7.65	7.35
0.10x0.4x1. 2	0. 4	8.85	8.50	8.30	8.15	8.00	7.75	7.50
0.10x0.4x1. 4	0. 4	9.30	8.95	8.75	8.60	8.45	8.20	7.95
1. 0x0.4x1. 4	0. 5	10.70	10.30	10.10	9.85	9.65	9.35	9.05
1. 0x0.4x1. 6	0. 6	11.20	10.70	10.45	10.20	9.95	9.45	9.20
1. 1x0.4x1. 6	0. 7	11.65	11.10	10.80	10.50	10.25	9.80	9.35
1. 2x0.4x1. 6	0. 7	12.50	11.95	11.65	11.35	11.10	10.65	10.20
1. 2x0.4x1. 8	0. 8	13.55	12.90	12.60	12.25	11.90	11.40	10.90
1. 3x0.4x1.10	0. 9	14.45	13.70	13.35	12.95	12.60	12.05	11.45
1. 4x0.4x1.10	0.10	16.70	15.85	15.40	15.00	14.60	13.95	13.35
1. 4x0.4x2. 0	0.11	19.00	18.10	17.65	17.15	16.70	16.05	15.35
1. 6x0.4x2. 4	1. 2	22.70	21.55	21.00	20.40	19.80	18.95	18.05
1. 2x0.5x1. 8	0.10	17.30	16.45	16.00	15.60	15.20	14.55	13.95
1. 3x0.5x1. 8	0.10	17.70	16.85	16.40	16.00	15.60	14.95	14.35
1. 4x0.5x1.10	1. 0	19.50	18.50	18.00	17.50	17.00	16.25	15.50
1. 4x0.5x2. 0	1. 1	20.40	19.30	18.75	18.20	17.70	16.85	16.05
1. 6x0.5x2. 2	1. 4	24.15	22.80	22.10	21.45	20.80	19.80	18.80
1. 6x0.5x2. 4	1. 6	26.50	25.00	24.25	23.50	22.75	21.60	20.50
1. 6x0.5x2. 6	1. 7	27.35	25.80	25.00	24.20	23.45	22.15	21.05
1. 4x0.6x1.10	1. 3	23.90	22.65	22.05	21.40	20.80	19.85	18.90
1. 4x0.6x2. 0	1. 4	25.45	24.10	23.40	22.75	22.10	21.10	20.10
1. 4x0.6x2. 2	1. 5	26.30	24.90	24.20	23.45	22.75	21.70	20.60
1. 4x0.6x2. 4	1. 7	28.05	26.50	25.70	24.90	24.15	22.95	21.75
1. 6x0.6x2. 6	1.11	30.90	29.00	28.05	27.05	26.10	24.70	23.25
1. 6x0.6x2. 8	2. 0	32.35	30.35	29.35	28.35	27.35	25.85	24.35
1. 8x0.6x3. 0	2. 6	39.95	37.45	36.20	34.95	33.70	31.80	29.95
1.10x0.6x3. 4	3. 1	47.45	44.35	42.80	41.25	39.75	37.40	35.10
1.10x0.6x3. 6	3. 3	49.20	45.95	44.35	42.70	41.10	38.65	36.20
2. 0x0.6x4. 0	4. 0	58.65	54.65	52.65	50.65	48.65	45.65	42.65
2. 2x0.6x4. 4	4. 8	66.15	61.50	59.20	56.85	54.50	51.00	47.50
2. 0x0.8x4. 0	5. 4	75.75	70.40	67.70	65.05	62.60	58.60	54.60
2. 2x0.8x4. 2	6. 0	83.20	77.20	74.20	71.20	68.20	63.70	59.20
2. 6x0.8x4. 6	7. 6	98.35	90.85	87.10	83.35	79.60	73.95	68.35
2. 6x0.8x5. 0	8. 4	107.85	99.50	95.30	91.15	87.00	80.75	74.50

Plain Greek Crosses

All Polished

0. 7x0.2x1. 0	0. 1	\$10.05	\$ 9.95	\$ 9.90	\$ 9.85	\$ 9.80	\$ 9.75	\$ 9.70
0. 8x0.2x1. 2	0. 2	12.00	11.85	11.80	11.70	11.60	11.50	11.35
0.10x0.2x1. 6	0. 3	13.20	12.95	12.85	12.70	12.60	12.40	12.20
0.10x0.3x1. 4	0. 3	14.05	13.80	13.70	13.55	13.45	13.25	13.05
0.10x0.3x1. 6	0. 4	15.15	14.80	14.60	14.45	14.30	14.05	13.80
1. 0x0.3x1. 8	0. 5	18.60	18.20	18.00	17.75	17.55	17.25	16.95
1. 0x0.3x2. 0	0. 6	19.95	19.45	19.20	18.95	18.70	18.30	17.95
1. 0x0.4x1. 8	0. 7	20.95	20.40	20.10	19.80	19.55	19.10	18.65
1. 0x0.4x2. 0	0. 8	23.60	22.95	22.65	22.30	21.95	21.45	20.95
1. 0x0.4x2. 2	0. 9	25.15	24.40	24.05	23.65	23.30	22.75	22.15
1. 2x0.4x2. 4	0.11	27.65	26.75	26.30	25.80	25.35	24.70	24.00

Plain Square Crosses

Two faces polished, edges sanded or all hand sanded

SIZES	Con- tents	STOCK—See Index page 16						
		D.	F.	G.	H.	I.	K.	L.
0. 7x0.2x0.10	0. 1	\$ 4.60	\$ 4.50	\$ 4.45	\$ 4.40	\$ 4.40	\$ 4.30	\$ 4.25
0. 8x0.2x1. 0	0. 1	4.85	4.75	4.70	4.65	4.65	4.55	4.50
0.10x0.2x1. 4	0. 2	5.50	5.35	5.30	5.20	5.10	5.00	4.85
0. 8x0.3x1. 0	0. 2	5.50	5.35	5.30	5.20	5.10	5.00	4.85
0.10x0.3x1. 2	0. 3	6.55	6.30	6.20	6.05	5.95	5.75	5.55
0.10x0.3x1. 4	0. 3	6.95	6.70	6.60	6.45	6.35	6.25	5.95
1. 0x0.3x1. 4	0. 4	7.65	7.30	7.10	6.95	6.80	6.55	6.30
1. 0x0.3x1. 6	0. 5	8.00	7.60	7.40	7.15	6.95	6.65	6.40
0.10x0.4x1. 2	0. 4	7.95	7.60	7.40	7.25	7.10	6.85	6.60
0.10x0.4x1. 4	0. 4	8.40	8.05	7.85	7.70	7.55	7.30	7.05
1. 0x0.4x1. 4	0. 5	9.70	9.30	9.10	8.85	8.65	8.35	8.05
1. 0x0.4x1. 6	0. 6	10.10	9.60	9.35	9.10	8.85	8.50	8.35
1. 1x0.4x1. 6	0. 7	10.40	9.85	9.55	9.25	9.00	8.60	8.50
1. 2x0.4x1. 6	0. 7	11.25	10.70	10.40	10.10	9.85	9.45	9.35
1. 2x0.4x1. 8	0. 8	12.20	11.55	11.25	10.90	10.55	10.05	9.80
1. 3x0.4x1.10	0. 9	12.95	12.20	11.85	11.45	11.10	10.55	10.25
1. 4x0.4x1.10	0.10	14.95	14.10	13.65	13.25	12.85	12.20	11.60
1. 4x0.4x2. 0	0.11	17.00	16.10	15.65	15.15	14.70	14.05	13.35
1. 6x0.4x2. 4	1. 2	20.30	19.15	18.60	18.00	17.40	16.55	15.65
1. 2x0.5x1. 8	0.10	15.55	14.70	14.25	13.85	13.45	12.80	12.20
1. 3x0.5x1. 8	0.10	15.95	15.10	14.65	14.25	13.85	13.20	12.60
1. 4x0.5x1.10	1. 0	17.50	16.50	16.00	15.50	15.00	14.25	13.50
1. 4x0.5x2. 0	1. 1	18.15	17.05	16.50	15.95	15.45	14.60	13.80
1. 6x0.5x2. 2	1. 4	21.40	20.05	19.35	18.70	18.05	17.05	16.05
1. 6x0.5x2. 4	1. 6	23.50	22.00	21.25	20.50	19.75	18.60	17.50
1. 6x0.5x2. 6	1. 7	24.10	22.55	21.75	20.95	20.20	18.90	17.80
1. 4x0.6x1.10	1. 3	21.40	20.15	19.55	18.90	18.30	17.35	16.40
1. 4x0.6x2. 0	1. 4	22.70	21.35	20.65	20.00	19.35	18.35	17.35
1. 4x0.6x2. 2	1. 5	23.30	21.90	21.20	20.45	19.75	18.70	17.60
1. 4x0.6x2. 4	1. 7	24.80	23.25	22.45	21.65	20.90	19.70	18.50
1. 6x0.6x2. 6	1.11	27.40	25.50	24.55	23.55	22.60	21.20	19.75
1. 6x0.6x2. 8	2. 0	28.85	26.85	25.85	24.85	23.85	22.35	20.85
1. 8x0.6x3. 0	2. 6	35.95	33.45	32.20	30.95	29.20	27.80	25.95
1.10x0.6x3. 4	3. 1	42.70	39.60	38.05	36.50	35.00	32.65	30.35
1.10x0.6x3. 6	3. 3	44.20	40.95	39.35	37.70	36.10	33.65	31.20
2. 0x0.6x4. 0	4. 0	53.40	49.40	47.40	45.40	43.40	40.40	37.40
2. 2x0.6x4. 4	4. 8	60.65	56.00	53.70	51.35	49.00	45.50	42.00
2. 0x0.8x4. 0	5. 4	69.75	64.40	61.70	59.05	56.60	52.60	48.60
2. 2x0.8x4. 2	6. 0	76.70	70.70	67.70	64.70	61.70	56.20	52.70
2. 6x0.8x4. 6	7. 6	91.35	83.85	80.10	76.35	72.60	66.95	61.35
2. 6x0.8x5. 0	8. 4	100.35	92.00	87.80	83.65	79.50	73.25	67.00

Plain Greek Crosses

Two faces polished, edges sanded or all hand sanded

0. 7x0.2x1. 0	0. 1	\$ 8.45	\$ 8.35	\$ 8.30	\$ 8.25	\$ 8.20	\$ 8.15	\$ 8.10
0. 8x0.2x1. 2	0. 2	10.25	10.10	10.05	9.95	9.85	9.75	9.60
0.10x0.2x1. 6	0. 3	11.35	11.10	11.00	10.85	10.75	10.55	10.35
0.10x0.3x1. 4	0. 3	12.05	11.80	11.70	11.55	11.45	11.25	11.05
0.10x0.3x1. 6	0. 4	13.15	12.80	12.60	12.45	12.30	12.05	11.80
1. 0x0.3x1. 8	0. 5	16.35	15.95	15.75	15.50	15.30	15.00	14.70
1. 0x0.3x2. 0	0. 6	17.45	16.95	16.70	16.45	16.20	15.80	15.45
1. 0x0.4x1. 8	0. 7	18.45	17.90	17.60	17.30	17.05	16.60	16.15
1. 0x0.4x2. 0	0. 8	20.85	20.20	19.90	19.55	19.20	18.70	18.20
1. 0x0.4x2. 2	0. 9	22.15	21.40	21.05	20.65	20.30	19.75	19.15
1. 2x0.4x2. 4	0.11	24.40	23.50	23.05	22.55	22.10	21.45	20.75

Lettering

Inscription Letters

	Commercial Gothic	Headed and Block, Roman or Modern English	Lombardic or Old English
V Sunk			
0.1½ high and less, each	\$.10	\$.16	\$.27
Over 0.1½ to 0.2 " "	.17	.27	.35

Raised in Panel

Ground work frosted or fretted

Raised ⅛ Inch			
0.1½ high and less, each	\$.25	\$.35	\$.55
Over 0.1½ to 0.2 " "	.35	.40	.62

Raised ¼ Inch			
0.1½ high and less, each	.55	.65	.90
Over 0.1½ to 0.2 " "	.65	.85	1.10

Raised ⅙ Inch			
0.1½ high and less, each	.16	.27	.40
Over 0.1½ to 0.2 " "	.27	.35	.55

Raised in Full Relief

Ground work smooth finish

Raised ⅛ Inch			
0.1½ high and less, each	\$.40	\$.55	\$.65
Over 0.1½ to 0.2 " "	.62	.65	.85
Over 2 to 2½ " "	.80	.95	1.10

If raised ⅜" extra 25%
If raised ½" extra 50%

Emblems

In circle not over 0.8 in diameter

	Traced	Carved in Sunk Panel ⅛ Inch	Carved in Sunk Panel ¼ Inch
Masonic	\$1.50	\$4.25	\$ 7.00
Eastern Star	4.25
Odd Fellows	1.50	3.25	5.75
Rebekah	2.75
Woodmen of the World	5.00
Knights of Pythias	2.00	5.50	8.25
Grand Army of the Republic	2.75	17.50
Junior United American Mechanics	2.00
Foresters of America	2.00
Women of Woodcraft	3.75
Cross and Crown	7.75
Clasped Hands (like No. 2089)	8.25
Single Hand (like No. 2102)	4.25
Single Hand (like No. 2090)	8.25
Lamb or Dove	4.25

Lettering

Family Name

	Commercial Gothic 0.2½ high and less	Commercial Gothic 0.2½ to 0.3	Commercial Gothic 0.3½ to 0.5
Sunk each	\$.35	\$.45	\$.60

Raised in Panel

Ground work frosted or fretted

Raised 0.0½ each	\$.55	\$.65	\$.80
“ 0.0¼ or 0.0⅓ each65	.85	1.00
“ 0.0½ each85	1.05	1.30

Raised in Full Relief

Ground work smooth finished

Raised 0.0½ each	\$1.20	\$1.50	\$1.80
“ 0.0⅓ “	1.50	1.80	2.15
“ 0.0¼ “	1.80	2.10	2.50

Add for extra stock when required.

Family name, headed and block letters, extra 35 per cent.

Old English

Letters in Monograms raised 0.0½ each	\$1.50
“ “ “ “ 0.0¼ “	2.00
Traced Old English letters50

Rounded or Rustic Lettering

In Full Relief, Smooth Finished

0.1½ high and less each	\$.60
0.1 to 0.2½ “90
0.2 to 0.3½ “	1.25
0.3 to 0.4½ “	1.85

Add for extra stock when required.

Square Sunk same price as rounded letters.

No full relief family name is to be charged less than six letters.

Ordinary Verse Letters (Italic)

Each	\$.05
----------------	--------

Specials

Details of lettering or monuments charged extra according to time required to execute.

Black or Gilded letters extra 50 per cent.

Leaded or Gold Leaf letters extra 100 per cent.

Hebrew letters double price of Gothic.

German script letters same price as Old English.

Russian letters same price as Headed letters.

Dashes and semicolons charged same as letters.

Three periods charged same as one letter.

Two commas charged same as one letter.

Matching lettering on rubbings, extra 10 per cent.

Extra deep lettering, extra 50 per cent.



Colket Mausoleum
Philadelphia, Pa.



Chambers Mausoleum
Elkton, Md.

Care of Marble

Give marble the care that it deserves, the care that any valuable product should receive and it will go down through the years unchanged, preserving its original beauty and character.

Every cemetery memorial should be cleaned once or twice a year and all the dirt, moss or lichens that has started to collect should be removed. These foreign substances absorb moisture and tend to roughen the surface. Keep the marble clean and this trouble will be averted.

For this cleaning, we recommend a solution of chloride of lime. Wash the stone thoroughly with it and then rinse with clean water and wipe dry.

The monument that has once become roughened can best be restored through treatment with pumice stone or fine grit.

Never use acid.

Never use a wire brush.

Never use soap or soap powders.

If a cleaning powder is found necessary, use Wyandotte Detergent. Sprinkle it on a sponge and rub the marble. Rinse thoroughly with clean water and wipe dry.

Stains

All stains should be removed as quickly as possible.

Oil stains are usually a light yellow. Apply high-test gasoline or naphtha on cotton waste or blotting paper and keep over the stain, saturating from time to time. Stains from marking crayons come in this class. Obstinate cases may require repeated treatments. Do not use a blow torch or other artificial heat. Within limits it is helpful, but the degree of heat is not readily regulated and burning the stone may easily result. The stain can be removed without it, although it takes longer. A poultice of hot lime on sand-finished or honed marble is often successful.

Pink or red-brown stains usually come from boxing, excelsior, leaves, or some organic substance. Such a stain is not usually serious nor permanent, and will often disappear upon exposure to the weather. The process may be hastened by application of a chloride of lime paste to sand-finished marble and a chloride of lime solution to polished surfaces.

Rust stains are difficult to remove. If on the surface and due to cinders, nails, etc., they should be rubbed off promptly. Never use iron or steel dowels or cushions.

Ordinary Grey Portland Cement is often the cause of stains. Use Atlas White Stainless Portland Cement for foundations and joints. Use clean water, clean sand, and clean tools. Our experience shows that stains not infrequently come from dirty aggregate. Plaster Paris and Keene cement are soluble in water and not suitable for joints or backing where there is moisture present.

Bronze stains are hard to remove. Use only U. S. Standard Bronze, natural finish, without oil, lacquer or oxidized surface.

Never use linseed oil putty in marble joints—it stains.

Stains will often disappear through the action of sunlight and frost when all else fails.

Price List
of
Monumental Supplies

GRITS

Fine Red	per lb.	\$.05
Fine Blue	"	.05
Medium Brown	"	.05
Coarse Ohio	"	.03
" " (200 lbs. or more)	"	.02½

PUMICE STONE

Best Selected	per lb.	\$.24
Best Selected, full barrels	"	.20

HONE

Scotch Selected	per lb.	\$.15
Black Selected, fine	"	.08
Caron	"	.10
Indiana rubbing stone	"	.06

POLISHING PUTTY

First Quality, in 1 lb. cans	per can	\$.80
First Quality, in 2 lb. cans	"	1.50
First Quality, in 12½ lb. or 25 lb. boxes	per lb.	.65
California Green	"	.85

POLISHING FELT

Sheet, 30 x 30, ¼ in. thick	per lb.	\$2.50
" ⅜, ½ or ¾ in. thick	"	2.50
Buffer Heads, 10, 12, 15 or 17 in. diameter, 3 in. thick	"	2.50

HARD WOOD ROLLERS

2 in., 8 ft. long each	\$.30	5 in., 4 ft. long each	\$1.00
3 " 4 " " " .50		6 " 4 " " " .50	1.50
4 " 4 " " " .80		8 " 4 " " " .80	2.00

MISCELLANEOUS

100 lb. Reel Wedge Setting Lead	per lb.	\$.14
50 " " " " "	"	.15
25 " " " " "	"	.16
Smaller Quantities Wedge Setting Lead	"	.15
Rock Island Sheepswool Sponges	"	2.75
Florida Yellow Sponges	"	1.75
Grass Sponges	"	1.10
Oxalic Acid, strictly pure	"	.40
Roll Brimstone (50 lb. lots)	"	.08
" " smaller quantities	"	.10
Aluminum Dowels, common sizes	"	.65
" " special sizes	"	.70
" " in rods (about 10 ft. long)	"	.60
Chilled Shot	"	.10
Flour of Emery	"	.25
Marble Wax	"	1.50
White Cotton Waste	"	.20
Excelsior, in bales	"	.03
Sea Sand, coarse or fine	per bbl.	4.00
"Alligator" Palmetto Fiber Brushes	each	.40
"Goose" Palmetto Fiber Brushes	"	.30

Prices on this page are subject to change

TOOLS

Mallet or Hammer Heads,	$\frac{1}{4}$ in. steel	per doz.	\$2.20
" " "	$\frac{5}{8}$ " " "	" "	2.75
" " "	$\frac{3}{4}$ " " "	" "	3.30
" " "	$\frac{7}{8}$ " " "	" "	4.15
" " "	$\frac{1}{2}$ " " blade under $2\frac{1}{2}$ in.	" "	5.50
" " "	" " " $2\frac{1}{2}$ to 3 in.	" "	6.60
" " "	" " " under $2\frac{1}{2}$ in.	per lb.	.55
" " "	" " " $2\frac{1}{2}$ in. and over	" "	.72
" " "	" " " any size	" "	.55

Frosting Tools,	1 in. steel	each	.55
" " "	" " "	" "	.61
" " "	" " "	" "	.72
Pitching Tools,	1 " " 2 to 3 in. wide	" "	1.27
" " "	" " " 2 to $2\frac{1}{2}$ in.	" "	1.05
" " "	" " " 2 in. and less wide	" "	.83
" " "	" " " $1\frac{3}{4}$ " " " "	" "	.61

An extra charge of 50c per dozen will be made for tools fitted for pneumatic hammers.

MISCELLANEOUS

Steel Lettering Hammers,	1 lb. and under	each	\$1.50
" " "	$1\frac{1}{4}$ lb.	" "	1.75
" " "	$1\frac{1}{2}$ lbs. to 2 lbs.	" "	2.10
" Mash Hammers		per lb.	.85
Bush Hammers,	2 in. square steel	each	7.25
" " "	$1\frac{3}{4}$ " " "	" "	6.25
Spaulding Hammers		per lb.	.55
Tooth Axes		each \$5.25 to	6.50
Hammer Points and Hand Drills,	$\frac{1}{2}$, $\frac{5}{8}$ and $\frac{3}{4}$ in. steel	per lb.	.45
" " "	$\frac{7}{8}$ and 1 in. steel	" "	.35
Bow Drill Stocks with Brass Pulley		each	12.50
Drills, Bows, Oval		" "	5.50
Bow Drill Strings, Wire covered		" "	1.50
Bow Drill Bits		per doz.	4.50
Moyer Drills,	$\frac{1}{2}$ to $\frac{3}{4}$ in. steel	each	.85
" " "	$\frac{7}{8}$ to 1 " " "	" "	1.00
Lewis Irons		each \$5.25 to	8.25
Polishers' Hand Scrapers,	$\frac{3}{8}$ in. steel	each	.45
" " "	$\frac{1}{2}$ " " "	" "	.55
" " "	$\frac{5}{8}$ " " "	" "	.80
" " "	$\frac{3}{4}$ " " "	" "	.90
Carvers' Files and Rasps,	6 in. long	" "	.90
" " "	7 " " "	" "	1.00
" " "	8 " " "	" "	1.10
" " "	9 " " "	" "	1.25
" " "	10 " " "	" "	1.50
Flat or Half Round Files, cut for marble,	14 in. long	" "	.60
Adjustable tongs. Maximum opening 3.6. Capacity 1 ton		" "	55.00
All tool steel crow bars 0.1 x 4.6 wgt. 12 lbs.		" "	2.50
" " " " " 0.1 $\frac{1}{2}$ x 5.0 wgt. 16 lbs.		" "	3.00

Mallets

BEST HICKORY WELL SEASONED

$2\frac{1}{2}$ lbs. and under	each	\$1.15
3 to $3\frac{1}{2}$ lbs.	" "	1.30
4 to $4\frac{1}{2}$ lbs.	" "	1.75

Sharpening Tools

Plain Tools	per hundred	\$4.25
Tooth " "	" "	8.25
Hand Scrapers and Hand Drills	each	.11
Frosters	" "	.22

Tools requiring new blades, extra charge.

Prices on this page are subject to change

CARBORUNDUM BRICKS

HAND

8 x 2 x 2	each	\$1.65
8 x 2 x 1	"	.95
4 x 2 x 1	"	.50

These bricks are stocked in the following grits:
 No. 40 (coarse), No. 80 (medium), No. 120 (fine), No. 180 and FF
 (very fine).

MACHINE

4½ x 3 x 1 x 2	each	\$1.10
3¼ x 2¾ x ¾ x 2	"	.75

These bricks are stocked in No. 50 grit only.

ALOXITE OR ALUNDUM BRICKS

HAND

8 x 2 x 1½	each	\$1.25
----------------------	------	--------

These bricks are stocked in a medium grit only.

MACHINE

4½ x 3 x 1 x 2	each	\$1.10
3¼ x 2¾ x ¾ x 2	"	.75

These bricks are stocked in a medium grit only.

EMERY HONE BRICKS

MACHINE

4 x 3½ x 1 x 2	each	\$.95
--------------------------	------	-------

These bricks are stocked in soft, medium and hard grit.

The following discounts will apply on all rubbing bricks listed:

When ordered in less than dozen quantity	Net
" " 1 dozen to 3 dozen	20%
" " 3 " or more	30%

ALUMINUM CUSHIONS

For maintaining joints in stone work, aluminum cushions resist the action of air, acids, and moisture—are absolutely stainless—and so light they can be easily carried in the pocket. Made up in two sizes only—1½" square by ⅜" thick. Price \$0.60 per dozen—\$2.25 for 50—\$4.00 for 100. 1" square by ¾" thick. Price \$0.50 per dozen—\$2.00 for 50—\$3.50 for 100.

ALUMINUM DOWELS

The dowel that never rusts. Lighter than iron—easier to handle and cut—yet strong enough for the heaviest work. Stocked in three sizes: 4 x ¾—4 x ½—6 x ¼. Prices: 65c per lb. Special sizes 70c per lb. In rods (about 10 feet long) 60c per lb.

VERMONT WHITE CEMENT

It is not surprising that the sale of this product has steadily increased, until it is the leading stone cement on the market.

A powder and liquid cement that is non-expansive and will not crack the marble—that is white in color and absolutely stainless, that may be easily colored to match different varieties of stone and marble, that is not affected by frost, water or time—best of all, a cement that is double the bulk of any other, therefore, a most economical product. To overcome complaints of coarseness, we are now bolting it through cloth in manufacture. The cement we are shipping now is whiter than in the past.

It has a crushing strength of ten tons to the cubic inch. By actual test it is three times as strong as clear Portland Cement—fourteen times as strong as one part Portland Cement and three parts sand. It makes a joint that is as solid and unbreakable as the stone itself.

It will help the dowel-pins do their work; it will close up the joints and keep out the water and dirt; it will work equally well whatever may be the form or size of the marble and whether the joint be straight or broken. In short, it is good for all kinds of monumental setting and it may be used more freely than other cements because it costs less.

We are revising the directions for the use of the cement to make it more fool proof and to protect you in its use. Follow the directions in using. Work vigorously, using quantities of liquids recommended and furnished in the package.

The 3-pound package (3 pounds of powder and 1 pint of liquid) Price, \$1.75
 The 6-pound package (6 pounds of powder and 1 quart of liquid) Price, \$3.00
 Extra liquid \$.75 per pint; \$1.25 per quart

Coloring Pigment

Red, Yellow and Brown (pound can) \$.50
 Black (pound can)75
 Green (quarter pound can) 1.00

Note—Samples of the coloring pigment are included in each can of cement

Prices on this page are subject to change

PHOTOGRAPHS

The value of a good photograph can hardly be estimated. Its influence on a prospective customer frequently counts for more than the salesman's argument. Indeed, many instances might be cited to prove that a well chosen list of photographs is in itself a salesman of no mean ability.

With this thought in mind, we have endeavored to keep our gallery thoroughly equipped in every way. That its efficiency has been appreciated is evidenced by the growth of the department—a growth that has been attended by the addition of hundreds of new negatives.

It has been deemed advisable to discontinue the use of the small photograph. All the new designs are obtainable only in large size photographs. We can still furnish the small size in the old designs.

Prices

Size (10½ by 13½ in.) flexible, per doz.	\$8.00
Size (10½ by 13½ in.) flexible lots less than 1 doz., each75
Size (10½ by 13½ in.) with extension flap for binding per doz.	8.50
Cloth binding, extra per book	3.50
Leather binding, extra per book, price on application.	

In addition to the foregoing, we have a stock of heavy, dark-gray Academy folders (size 11" x 14") suitable for the mounting of the black-and-white, dull-finish photographs, known as Azo prints that we are prepared to furnish to the trade. These prints are made on double-thick paper and require in the finishing a much greater outlay both of material and labor. Only the later and larger designs can be furnished in this style of photo and they are to supplement rather than replace our other photographs.

Our price to the trade for these Azo prints in folders will be \$1.25 each, \$6.50 per one-half dozen, or \$12.00 per dozen. On orders amounting to \$15.00 or more, a discount of 10% will be allowed.

Epitaph Books, each 25c., per doz.	\$2.00
Expeditious Calculator, each	3.50

DESIGN BOOKS

Design Book "N" is a collection of about two hundred and seventy-five regular designs, bound similarly to Design Book "M", but in a larger size with an entirely different form of illustration.

Design Book "O" is a Cross Book. It is uniform in size and treatment with Design Book "N," containing one hundred and forty-four pages.

Design Book "P" is a Children's Book, made up of one hundred and twelve pages. This also is similar to Design Book "N", having the same height and width and the same substantial binding.

"Modern Marble Memorials"

A collection of forty or more modern designs, printed in sepia ink on dull-coated India paper, and richly bound in heavy paper covers. Contains also many small illustrations of Vermont marble memorials and the quarries and shops that produced them. Size 7½ x 10. Price each, \$1.50.

Design and Sample Cases

Case "A."

Made from selected leather, brass trimmed, with sewed joints and extra protection on the corners. The interior is lined with plush throughout and provided with two hinged partitions. Size 16½ by 13 in., each \$30.00

Case "AA."

A flexible all-leather case with all joints sewed, containing two large pockets for photographs and designs, also smaller compartments for order books, stationery, samples, etc. Thoroughly durable and yet light enough to be easily carried. Size, 16½ by 12½ in., each \$27.00

Case "B."

Similar in style to case "A." Some of the joints are riveted instead of sewed and portions of the interior are lined with canvas. Size, same as case "A," each \$24.00

Case "BB."

Made from selected leather. A plain case without partitions, lined throughout with genuine linen. Cover reinforced with steel valance. A good case for agents wanting something smaller and plainer and of best quality. Size, 15½ by 12½ in., each \$18.00

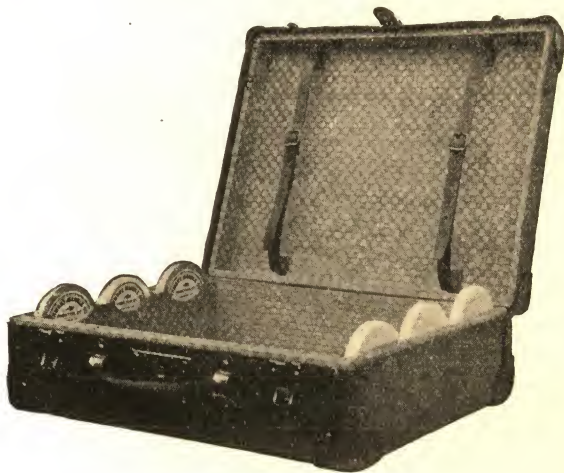

Case "C"

Case "C."

A brass-trimmed case. All joints are riveted. The lining is of canvas and there are no partitions. Size, same as case "A," each \$10.00
 Prices on this page are subject to change

Index

	<i>Page</i>
Aloxite or Alundum Bricks.....	564
Aluminum Cushions and Dowels.....	564
Balls.....	551
Benches.....	537, 538, 539, 540
Bottom Bases.....	10, 16
Bottom Bases (S.S.).....	15
Branches.....	5
Burial Vaults.....	548
Carborundum Bricks.....	564
Card Receivers.....	552
Cement, Vermont White.....	565
Cemetery Vases.....	547
Care of Marble.....	560
Coping, Prices and Designs.....	11, 546, 547
Crating.....	12
Crosses.....	554, 555
Crucifix Crosses.....	553
Design Books.....	566
Design Cases.....	567
Doves.....	552
Drilling.....	541
Emblems.....	556
Emery Bricks.....	564
Enclosures, Grave.....	535, 539
Entrance Steps.....	535
Figures.....	552
Finials.....	550
Flower Pots.....	534
Finish (M.M.).....	15
Foot Stones.....	10
Freight.....	6
Grave Covers.....	11
Grave Enclosures.....	535, 539
Greek Crosses.....	554, 555
Headstones, Plain Finished.....	541
Index to Grades of Marble.....	16
Lambs.....	552
Ledger Slabs.....	536
Lettering.....	556, 557
Marble, Brandon Italian.....	9
Marble, Pittsford Italian.....	9
Marble, Pittsford Valley.....	9
Marble, Riverside.....	9
Marble, Rutland White.....	8
Marble, Sutherland Falls.....	9
Marble, Vermont Blue.....	8

	<i>Page</i>
Markers in Various Designs.....	542-545
Markers, Plain Finished.....	545
Markers to set in ground.....	545
Mausoleums.....	558, 559
Miscellaneous Rough Stock Prices.....	12
Monumental Finishing Rules.....	14
Monumental Designs.....	17-533
Mortises.....	541
Ornamental Crosses.....	553
Photographs.....	566
Posts, Prices and Designs.....	546, 547
Posts, Rough.....	10
Rolls.....	551
Sand Rubbing.....	12
Seats and Benches.....	537, 538, 539, 540
Stains.....	560
Sundial Pedestal.....	537, 540
Supplies.....	562, 564
Tenons.....	541
Terms.....	6
Tools.....	563
Urns, Carved.....	549
Urns, Plain.....	550
Vases.....	537, 539, 552
Vaults, Burial.....	548



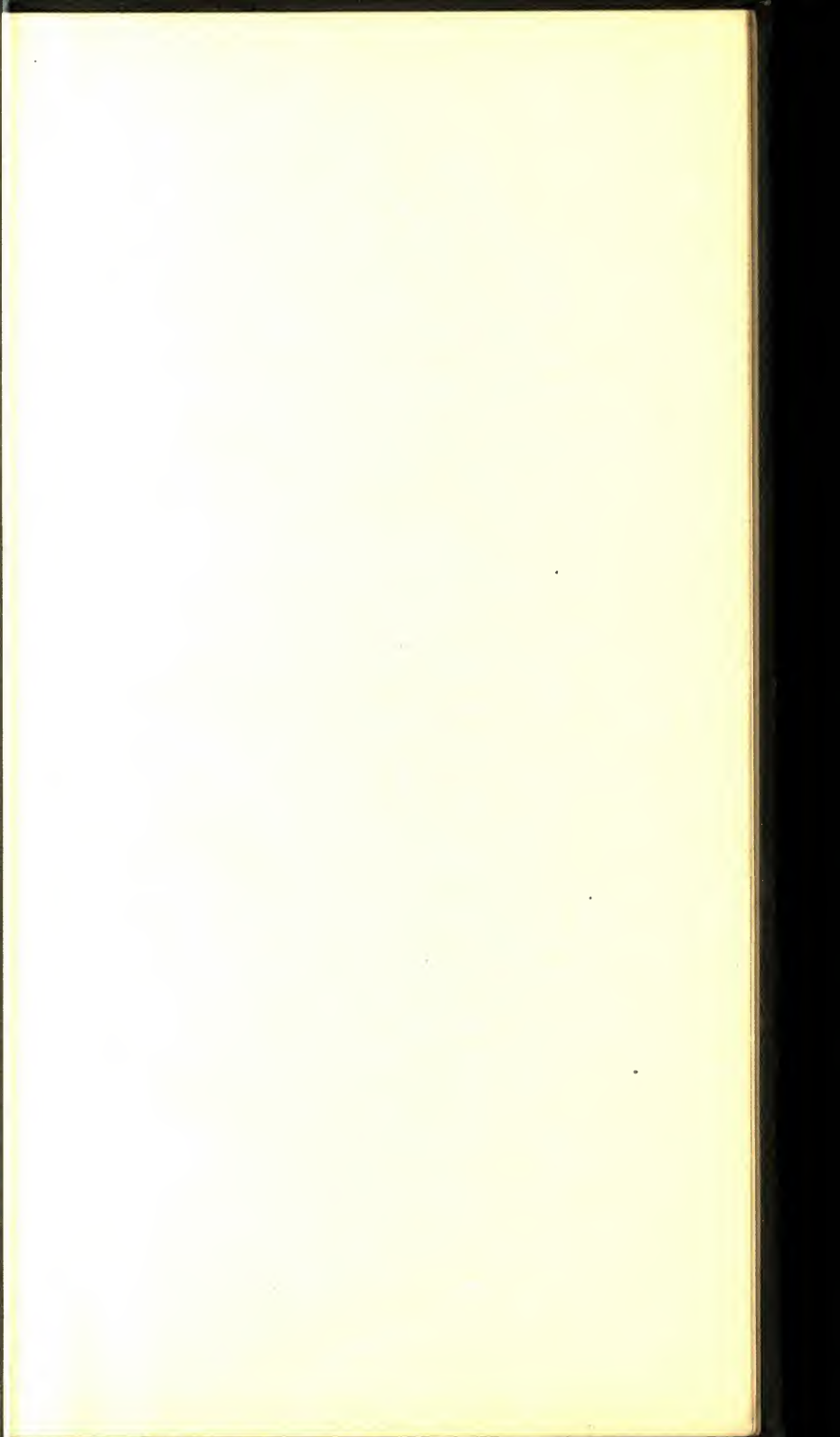





28

570

2.40 dia

4.50 ME

.90 castles

9.00 labor

5.50 2nd

$\frac{42}{1140}$

$\frac{2280}{23940}$

9

$55 \int \frac{56.30}{495}$

80

$\frac{84}{}$

$65 \int \frac{5030}{485}$
 $\frac{480}{}$

$60 \int \frac{5030}{480}$
 $\frac{730}{}$

$\frac{22}{5}$
 $\frac{10-10}{}$



1050
 40
 100
 500
 200
 2200

150
 270
 20
 40
 16
 50
 120
 100
 120
 100
 200

6
 67
 1150
 1300
 200
 8
 10617
 511

1160
 12
 580
 160
 17

2
 16
 3
 16
 5
 6
 46
 15
 226

55
 106
 11
 17
 271

